



Netavis Observer 5.1

User Manual

English



Netavis Observer 5.1 User Manual

Valid from Observer 5.1.0

Published in February 2021

The software described in this manual is licensed under the terms of the Netavis End User License Agreement and may only be used in accordance with these terms.

Copyright

Copyright © 2003-2021 Netavis Software GmbH. All rights reserved.
Netavis and Observer are trademarks of Netavis Software GmbH. All other trademarks are trademarks of their respective holders.

Netavis Software GmbH
Handelskai 388, Top 221
A-1020 Vienna
Austria

Tel +43 (1) 503 1722
info@netavis.net
www.netavis.net

Contents

1 Introduction.....	6
1.1 The Observer documentation set.....	6
1.2 What is new with this release.....	6
1.3 Observer data security	7
1.4 Video streaming methods and compression	7
2 Observer clients on multiple platforms.....	11
2.1 Introduction to Observer clients.....	11
2.2 Working with the installed Observer client.....	12
2.3 Client multi-window and multi-screen operation.....	17
2.4 Client preferences	19
2.5 Mobile Observer clients	21
2.6 Observer Transcoding for low-bandwidth client-server connections (ABS)	27
2.7 Exiting the client.....	28
3 Guidelines for setting up a new system with Observer	29
3.1 Guidelines for setting up cameras.....	29
3.2 Guidelines for setting up users.....	30
3.3 Guidelines for setting up views	30
4 Setting up cameras	31
4.1 Preparations.....	31
4.2 Adding a new camera and basic configuration	31
4.3 Setting up the camera recording archive.....	41
4.4 Checking the camera status	41
4.5 Optional: Configuring video analytics (iCat).....	42
4.6 Working with camera groups.....	42
4.7 Changing the port mapping of analog cameras.....	43
5 Managing users.....	44
5.1 Creating a new user account	44
5.2 Setting general user privileges	46
5.3 Setting camera access rights.....	50
5.4 Working with user groups.....	52
5.5 Defining Online Monitor views for a new user.....	52
5.6 Information about logged-in users	53
5.7 Changing the password	53
5.8 Working with Active Directory and LDAP users.....	53
6 Using the Online Monitor	54
6.1 Creating a new view.....	54
6.2 Selecting cameras.....	55
6.3 Navigating in the Online Monitor.....	56
6.4 Modifying view port settings.....	57
6.5 Zooming in a view port and in archive recordings.....	59
6.6 Manual recording control in the Online Monitor.....	59
6.7 Working with round tours (the Smart guard function).....	61

6.8 Copying views between users	62
6.9 Working with MPEG cameras and audio (MPEG-4, H.264, H.265, and MxPEG).....	63
6.10 Dynamic View Control in Online Monitor.....	64
7 Working with archive recordings	72
7.1 Programming archive recordings.....	72
7.2 Playback of archive recordings	73
7.3 Exporting recordings (images and video sequences)	79
7.4 Motion detection in archive recordings	81
7.5 External archive management (NEA)	83
8 Working with motion detection	86
8.1 Observer’s own server-based motion detection	86
8.2 Motion detection in archive recordings	89
8.3 In-camera motion detection.....	89
9 Handling events.....	92
9.1 Event list and event details	92
9.2 Searching for and exporting events	94
9.3 Generating an event statistics report.....	97
9.4 Receiving notification on events.....	98
10 Working with PTZ cameras	100
10.1 Setting up a PTZ camera	100
10.2 Defining fixed PTZ positions.....	100
10.3 Defining PTZ routes.....	100
10.4 Controlling PTZ cameras.....	101
11 Administrating Observer servers.....	107
11.1 Server system information and restarting.....	107
11.2 Setting Observer server parameters	109
12 Working with interconnected Observer servers.....	117
12.1 Basic concepts of distributed systems.....	117
12.2 Adding and defining a remote Observer server	118
12.3 Working with cameras of another server	119
12.4 Working with events of remote servers	121
12.5 Monitoring remote servers.....	121
12.6 Keeping multiple users servers in sync (synchronization groups)	121
12.7 Distributed upgrades	122
12.8 License allocation.....	122
13 Active Directory Integration	124
13.1 Configuring the users on the Active Directory server	124
13.2 Configuring Observer	125
14 Working with Layout Navigation	128
14.1 Basic concepts and how it works	128
14.2 Installing Layout Navigation.....	128

14.3 Starting Layout Navigation	129
14.4 Setting up a project and defining layouts (Editing mode)	129
14.5 Customizing the behavior and appearance of controls	133
14.6 Layout navigation and operation (Navigation mode).....	138
15 Video analytics with iCat	142
15.1 iCat highlights.....	142
15.2 Basic iCat concepts	143
15.3 Setting up a camera for video analytics with iCat.....	146
15.4 Working with iCat.....	164
16 I/O Device Administration.....	170
16.1 Configuring I/O devices	170
16.2 Generic I/O devices.....	171
17 Rule Administration	172
17.1 Configuring rules.....	172
18 NPR List Management	178
18.1 Configuring number plate lists.....	178
19 Automatic Export	181
19.1 Configuring automatic exports	181
20 External Device Administration.....	184
20.1 Configuring external devices	184
21 Schedule Admin	187
21.1 Configuring schedules	187
22 Video walls with Observer	188
22.1 Setting up a video wall with Observer.....	188
22.2 Controlling the video wall with the control application	190
23 Special functions.....	193
23.1 Video annotations.....	193
23.2 Embedding Observer video streams in web pages (Video4Web)	193
23.3 Controlling Observer with HTTP commands from external sources (URL control)	194
23.4 Matrix View function of the Online Monitor (VIP control)	195
23.5 Holiday calendar.....	197
23.6 Automatic export of event statistics	198
23.7 Configuring I/O devices	199
23.8 AXIS T8310 Control Board configuration	200
23.9 SNMP Support (Simple Network Management Protocol)	203
24 Index	209

1 Introduction

Thank you for choosing Netavis Observer 5.1 as the management software for your video monitoring system. As you use it, you will find that Observer not only enables you to view live images and record them, but also provides a full-scale platform for the intelligent utilization of your video data.

This User Manual guides you through the functionality of Netavis Observer 5.1.

If you have questions that are not answered in the Observer documentation set, please contact your Netavis partner, or else get in touch with us via the usual channels.

We wish you a great experience with Netavis Observer 5.1.

Your Netavis Team.

1.1 The Observer documentation set

These documents are available:

- *Netavis Observer User Manual*: It describes how to configure and use the Observer client.
- *Netavis Observer Supported Video Sources*: It provides detailed information on the IP camera models supported by Observer.
- *Netavis Observer Server Installation and Administration*: It describes how to install and manage an Observer system.
- *Netavis Observer Server, Client and Storage Compatibility and Requirements*: It explains the hardware and software requirements for Observer systems.
- *Netavis Observer Server Customizing*: It provides an overview on how to customize various aspects of an Observer server.
- *Netavis Observer SNAP XML Interface*: It describes the Simple Netavis Access Protocol (SNAP) that allows bidirectional communication between an Observer server and third party applications.
- *Netavis Observer SNAP URL*: It describes the SNAP URL API which is a simple and effective way for Observer to interface with third party applications.

These documents are available online as PDFs directly on each Observer server via the standard web interface and also from each client via the **Help - All Documentation** menu.

1.2 What is new with this release

The changes of a release are documented in the **Release Notes**, which you can find on the standard web interface of each Observer server and also under the following direct link:

<http://<your-server>/relnotes>

or on the public demo server

showroom.netavis.net/relnotes

There you also find the release information of previous releases.

Additionally, the new features of releases are also documented on www.netavis.net.

1.3 Observer data security

Observer has been designed to provide the highest level of robustness and data security. The following aspects of the Observer system document that:

- All video and configuration data on an Observer server are stored in separate file system partitions, protected by multiple levels of security.
- Optionally the video data can be stored using 128 bit AES encryption (since Observer 4.0)
- Optionally HTTPS can be used for streaming video data between cameras and servers (since Observer 4.0).
- Optionally HTTPS can be used for streaming video data between server and clients (since Observer 4.2).
- In any case, the authentication data (user names and passwords) transferred between clients and servers are encrypted by MD5 strong encryption.

Please note: Encryption and decryption can mean higher CPU overhead at the server and/or the client. Also doing something with the contents of an encrypted stream means decryption and therefore higher CPU overhead. For example, doing video analytics with an encrypted video stream means that it has to be decrypted at the server before processing. Likewise, storing an unencrypted stream in an encrypted video database means that it has to be encrypted at the server before storing. Likewise, displaying an encrypted video stream at the client means more CPU overhead at the client because it has to be decrypted.

On the other hand, simply storing an already encrypted video stream coming from the camera does not need more CPU at the server than storing an unencrypted video stream.

1.4 Video streaming methods and compression

Observer supports video streaming in several standards:

- Motion JPEG (often also referred to as MJPEG)
- MPEG-4 streaming
- H.264 streaming (also known as MPEG-4/AVC)
- H.265 streaming (also known as HEVC)
- MxPEG streaming (this is a streaming standard specially developed by www.mobotix.com for their IP cameras)

The big difference between the various streaming methods is the way how the image data are compressed and transferred. The selected streaming method has great influence on:

- the **bandwidth** needed for transmission between cameras and server but also between servers and clients,
- the **CPU load** at the server and the client induced by compression and decompression, and
- the **storage requirements** for recording

For low-bandwidth client-server connections Observer offers the unique Transcoding feature (see 2.6 *Observer Transcoding for low-bandwidth client-server connections (ABS)* on page 27).

1.4.1 Multi streaming (multiple parallel video streams from the camera)

Some cameras are capable of providing multiple parallel video streams to Observer. This can be helpful, for example, when online viewing and recording is to be done in different formats (e.g. different sizes and frame rates) or for optimizing iCat video analytics performance (see *15.2.1 Considerations for setting up a system with iCat* on page 144).

Usually MJPEG cameras can deliver several MJPEG streams while MPEG cameras (MPEG-4, H.264, H.265, and MxPEG) usually can deliver only 1 or 2 MPEG streams and some camera types can deliver several MJPEG streams in addition to the MPEG stream(s).

However there are a few important restrictions with multi streaming:

- Some cameras have performance limitations in providing multiple streams depending on the streaming format, resolution, and frame rate. We found out that some cameras just stop streaming when the streaming processors of the camera get overloaded by certain resolution and frame rates settings. Please refer to the camera data sheet and documentation.
- In the current version Observer supports 1 format setting for MPEG streams (MPEG-4, H.264, H.265, and MxPEG) and multiple format settings for MJPEG streams.

Please note: Please refer to camera data sheet and documentation for camera limitations. Also the document *Netavis Observer Supported Video Sources* may provide further details on camera restrictions.

1.4.2 Motion JPEG

A network camera captures individual images and compresses them into a JPEG format. The network camera can capture and compress, for example, 30 such individual images per second (30 fps), and then make them available as a continuous flow of images over a network to an Observer server which then distributes it to Observer clients and / or stores it in the camera archive. At a frame rate of about 16 fps and above, the viewer will perceive full motion video.

As each individual image is a complete JPEG compressed image, they will all have the same guaranteed quality, determined by the compression level as defined for the network camera or network video server.

Example of a sequence of three complete JPEG images:

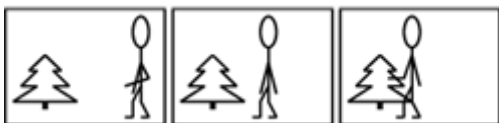

1.4.3 MPEG (MPEG-4, H.264, H.265, and MxPEG)

Some of the best-known audio and video streaming techniques are defined by the so called MPEG consortium (Moving Pictures Expert Group). Under the MPEG umbrella several streaming methods are available like MPEG-4, H.264, H.265, and MxPEG (strictly taken, MxPEG is not part of the standards defined by the MPEG group but is a proprietary standard by the company Mobotix. However, because of reasons of simplicity we refer to MxPEG also as an MPEG format). MPEG-4 and H.264 are well known and widely supported MPEG streaming standards.

Simply described, MPEG's basic principle is to compare two compressed images to be transmitted over the network, and using the first compressed image as a reference image (called an I-frame), only

sending the parts of following images (B- and P-frames) that differ from the reference image. A viewing client will then reconstruct all images based on the reference image and the “difference data”.

At the cost of higher complexity, the result of applying MPEG video compression is that the amount of data transmitted across the network is less than that of Motion JPEG. This is illustrated below where only information about the differences in the second and third frames is transmitted

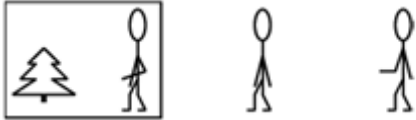

H.264 and MxPEG all work very similar to MPEG-4 whereby H.264, for example, needs only about 60% of the bandwidth of MPEG-4 for roughly the same video quality. However, this efficiency does not come for free. Encoding and decoding H.264 needs more CPU power than MPEG-4. A general rule is that the higher the compression factor the heavier the CPU burden (in the server and in the clients). Therefore there is always a tradeoff between bandwidth utilization and CPU power needed.

1.4.4 Advantages and disadvantages of Motion JPEG and MPEG (MPEG-4, H.264, H.265, and MxPEG)

Due to its simplicity, Motion JPEG (MJPEG) is a good choice for use in many applications. JPEG is a widely available standard in many systems often by default. It is a simple compression/decompression technique, which means the cost, in both system time and money, for encoding and decoding is kept low. The time aspect means that there is limited delay between image capturing in a camera, encoding, transferring over the network, decoding, and finally displaying at the viewing station. In other words, MJPEG provides low latency due to its simplicity (image compression and complete individual images), and for this reason it is also well suited for when image processing is to be performed, for example video motion detection or object tracking.

MJPEG gives a guaranteed image quality regardless of movement or complexity of the image scenes. It still offers the flexibility to select either high image quality (low compression) or lower image quality (high compression) with the benefit of lower image file sizes, thus lower bit-rate and bandwidth usage. At the same time the frame rate can be easily controlled, providing a means to limit bandwidth usage by reducing the frame rate, but still with a guaranteed image quality.

Since MJPEG does not make use of a video compression technique, it generates a relatively large amount of image data that is sent across the network. For this reason, at a given image compression level (defining the image quality of the I-frame and JPEG image respectively), the network bandwidth is less for MPEG compared to MJPEG, except at very low frame rates.

Another difference is that most MJPEG IP cameras can produce multiple simultaneous streams and in different qualities (image sizes and compression quality) while most MPEG cameras can produce only one stream in one quality. Therefore the same stream will be used in live viewing and recording.

This summarizes the benefit of MPEG: the ability to give a relatively high image quality at a lower bit-rate (bandwidth usage). This can be especially important if the available network bandwidth is limited, or if video is to be stored (recorded) at a high frame rate and there are storage space restraints. The lower bandwidth demands come at the cost of higher complexity in encoding and decoding, which in turn contributes to a higher latency when compared to MJPEG.

The graph below shows in principle how bandwidth use between MJPEG and MPEG compares at a given image scene with motion. As can be seen, at very low frame rates, where MPEG compression cannot make use of similarities between neighboring frames to a high degree, and due to the

overhead generated by the MPEG streaming format, the bandwidth consumption is actually higher than MJPEG.

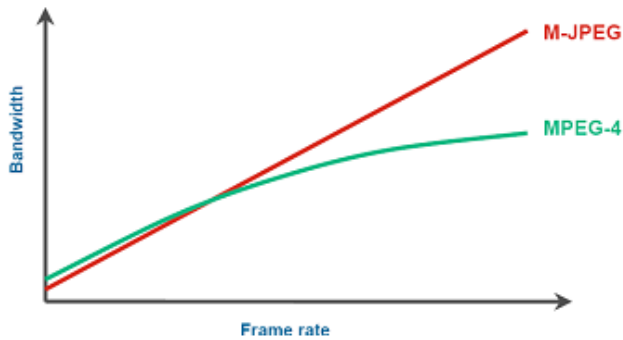

1.4.5 JPEG image sizes and storage requirements

The image (recording) quality and image size affects the required storage per image (frame). Likewise does the frame rate impact the recording storage and also the network bandwidth.

Observer supports all image sizes that a camera offers. The following are some **values for typical JPEG images**:

JPEG Image size	Image quality	Storage per image approximately
Small 176x144 QCIF PAL 176x120 QCIF NTSC 160x120 QQVGA	Low	3 KB
	Medium	5 KB
	High	8 KB
Medium 352x288 CIF PAL 352x240 CIF NTSC 320x240 QVGA	Low	8 KB
	Medium	13 KB
	High	20 KB
Large* 704x576 4CIF PAL 704x480 4CIF NTSC 640x480 VGA	Low	20 KB
	Medium	34 KB
	High	52 KB

* For mega-pixel cameras the image size will be much bigger than shown in the table.

2 Observer clients on multiple platforms

2.1 Introduction to Observer clients

Once you have successfully installed Observer on your server, authorized users can access the server via an Observer client.

Normally the Observer client runs on a PC separate from the server, however in a client-on-server installation the client runs directly on the server (see the document *Netavis Observer Server Installation and Administration* for further information on how to create and run a client-on-server installation).

Clients for various platforms

You can choose among these Observer clients, operating systems and platforms:

Observer client	OS and platform	Supported functionality
Locally installed desktop client	Microsoft Windows 10	All
	Linux, Unix (also client on server CoS)	No audio, Layout Navigation, and PTZ-Joysticks
Mobile Client	many smartphone platforms and OSes	Live viewing and archive playback

Note: The Mac OS X operating system hasn't been supported since Observer 4.0.

Please be aware that some functions like Layout Navigation and running SAFE export files are only available on the MS Windows platform.

This chapter describes how to start the Observer client on a desktop PC. If you want to run Observer on a mobile device please refer to *2.5 Mobile Observer clients* on page 21.

The minimum screen resolution for running the Observer client is 1024x768 pixels.

Licensing issues

The available functionality of your Observer installation is defined by the license file. The document *Netavis Observer Server Installation and Administration* describes how licensing works and how to obtain a license string. If you have a temporary demo license, a **License** dialog appears at every login indicating that there is no permanent license. At this dialog just press the **Continue** button to operate Observer in the demo mode.

See *11.1 Server system information and restarting* on page 107 for how to display the current license of your server.

2.1.1 Advanced client technology

The Observer uses advanced technologies to ease the operation of clients on MS Windows platforms:

- **Lazy-loading client technology:** Observer clients (both browser-based and locally installed) only load the needed application components from the server on demand, when they are needed. This saves time at startup and also bandwidth. It also eases the management and upgrading of clients. Libraries for one version are downloaded only once and are then stored locally on the client machine. The path is <user's home directory>\netavisLibs\<version> (e.g. C:\Documents and Settings\user\netavisLibs\4.4.5.158.634).
- **Automatic client upgrading:** Whenever the Observer server is upgraded to a new version, the clients are automatically upgraded too. This is happening transparently to the user. The same client will still be able to work with older server versions (see next point). Since release 1.9 the client application has to be installed only once and every further Observer version will be seamlessly accessible, without having to manually upgrade the client.
- **Different versions between servers and clients:** Since release 1.9 Observer clients can connect to servers running different versions (release 1.9 or newer) without the need to install clients matching the servers' versions.

As a summary, Observer clients...

- ...download libraries (for one version) only once
- ...share the same libraries for both browser-based (applet) and installed client application
- ...can connect to servers having different versions
- ...automatically upgrade themselves when the server has a new version

2.2 Working with the installed Observer client

The most common way to use the Netavis Observer client is to install it locally on your machine. Some functions are only available in the installed client (see *2.1 Introduction to Observer clients* on page 11 for details).

2.2.1 Installing the Observer client

To **install** the client locally on your PC, please follow these steps:

1. On the **Observer Start page** click on the link **Download Observer client installer (Windows only)**.
2. Save the client installer executable at an arbitrary location.
3. Execute the just downloaded client installer (setup.exe).
4. Follow the steps of the setup program (standard Windows installation).

2.2.2 Starting the installed Observer client

Once the setup finished you can start the client locally from your Windows **Start** menu (or also from a desktop icon if you selected so at installation). The **Starter** window appears:

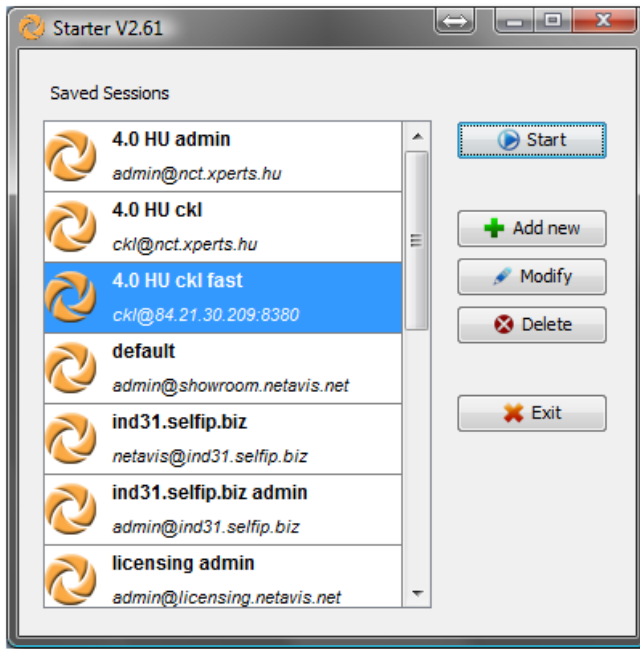

Working with sessions

The **Starter** allows you to manage sessions. In a session you can define the server address, which Observer application to start and the user/password details. Thus, you can store and run different sessions easily.

The **Session editor** is opened when you press **Add new** or **Modify** and allows you to define the session details:

Element	Description
Session name	Name under which the session is stored.
Application	You can either choose Observer Client or Layout Navigation Tool (for further details on the Layout Navigation Tool please refer to <i>14 Working with Layout Navigation</i> on page 128). The selected application will start when you press OK .
Previous Connections	Offers you the list of previously active sessions.
Hostname or IP address	Enter the name or IP address of the server you want to connect to.
Use secure connection	Select this checkbox if you want to use an encrypted connection between the client and the server (TLS HTTPS). Please be aware that an encrypted connection needs more CPU resources on the server and on the client. See also <i>1.3 Observer data security</i> on page 7.
Username	Enter the login name of the user.
Password	Enter the password for the user.
Remember password	Select the checkbox if you want the password to be remembered for the next start of the application.
Alternative Session	Here you can select another session out of the already defined

Element	Description
	session that should be started automatically when the server of this session is not accessible.
Show message if alternative session started	Select this checkbox if a message should be shown when the alternative session is started.
Download client without asking	<p>Select this checkbox if you want updated versions of the client to be downloaded automatically.</p> <p>Note: Enabling this option is particularly recommended for systems without a mouse and keyboard.</p>
Reconnect count	<p>Here you can set how many times the client will try to reconnect to a server which it has lost its connection to.</p> <p>Note: This does not handle situations in which no connection is available upon the initial start of the client.</p>

Starting the Observer client

Pressing **Start** in the **Starter** will open the client window and connect you to the Observer server. When the client is started, the **Starter** window will be hidden and in the task bar you will see its icon. You can access the Starter by clicking its icon. There you can open the Starter dialog again and also force an exit of the client application.

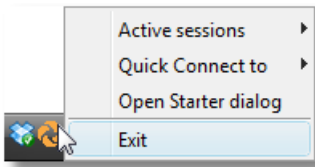

When you start the client the first time after a new installation some additional client application components need to be installed (this is needed only once per client). You will be asked:

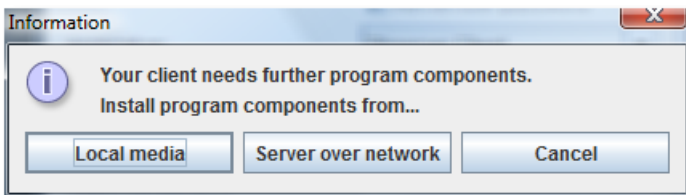

Normally you want choose to install the program components from **Server over network**. However, if you have a very slow network connection between the client and the server you might want to choose installation from **Local media**. When you choose this option you will be asked to locate the directory **ClientInstaller** of the Observer installation CD. Once you choose the correct location and push OK, the components will be installed.

Note: If you enable the **Download client without asking** option you won't be presented with this dialogue.

If you do not yet have a permanent license for Observer, a **License** dialog appears. To continue without a permanent license just press **Continue**. In this case the full functionality may not be available. See also *2.1 Introduction to Observer clients* on page 11 for further details about licensing.

Note: As of Netavis Observer 5.1 the default passwords for the pre-configured users have to be changed upon the first login.

Starting multiple sessions of the Observer client

It is also possible to start multiple sessions of the Observer client with a single shortcut. To do so you need to right-click on an existing shortcut to the Observer client and open its **Properties**. In the **Target** field you can then add the names of the saved sessions which you would like to be started upon clicking on the shortcut (e.g. "C:\Program Files\NETAVIS Observer\na.bat" "4.5.2 NCS" "4.5.2 NUS" will open the two saved sessions called "4.5.2 NCS" and "4.5.2 NUS"):

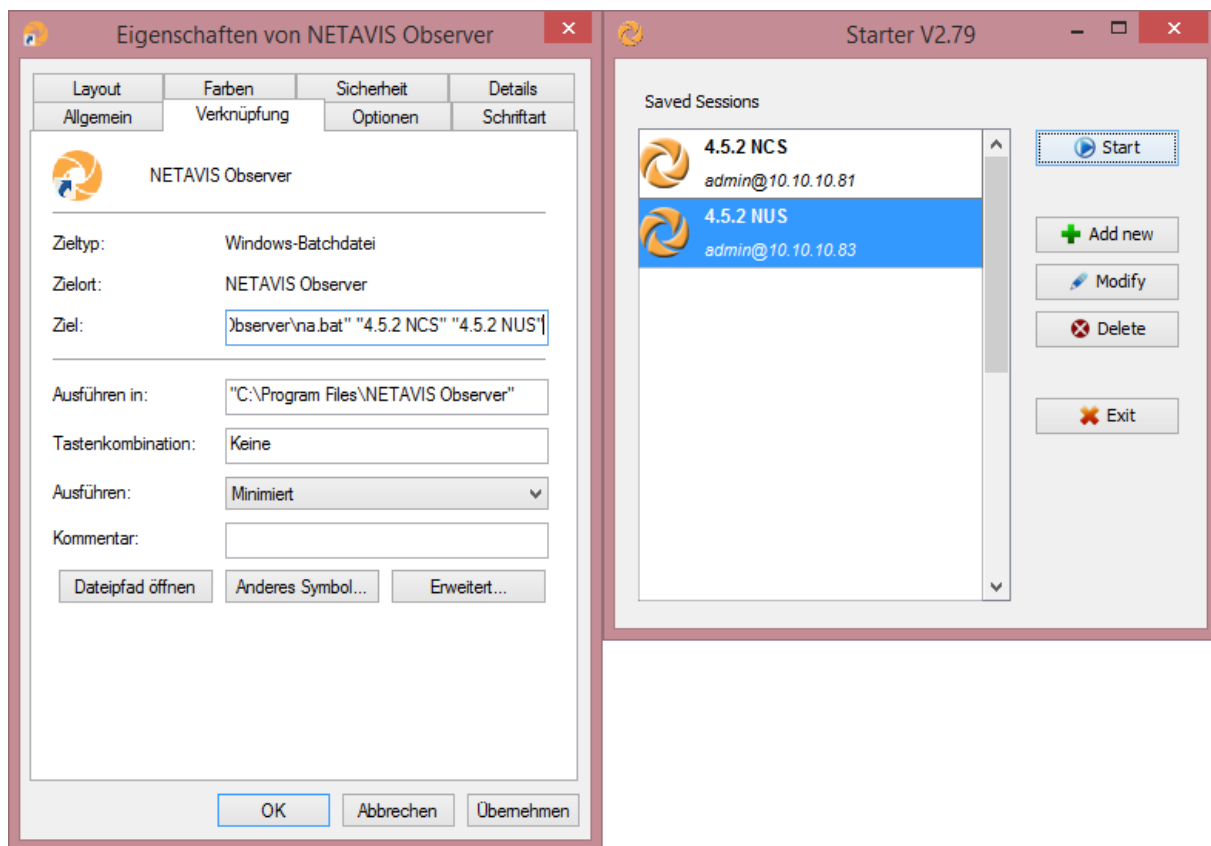

Using a different directory for the installed client application components

Per default, the downloaded client application components will be installed in the directory %USERPROFILE%\netavisLibs (e.g. C:\Documents and Settings\user\netavisLibs). You can change this directory by setting the environment variable NETAVIS_DIRECTORY. The directory must exist prior to starting the Observer client. If the variable does not exist, the client components will be installed in the standard directory.

Here is how you can set an environment variable in Windows 7:

1. Right click on the Computer icon in your Explorer or on your Desktop and choose **Properties**.

2. In the System window click on **Advanced system settings** in the left pane.
3. In the **System Properties** window select **Advanced** tab and click on the button **Environment Variables** at the bottom of the dialog.
4. In the **Environment Variables** window you will notice two tables **User variables** for the current user and **System variables** for all users.
5. To add a new **User variable** click on **New...** button. In the **New User Variable** dialog box enter the variable name `NETAVIS_DIRECTORY` and the location of the directory and then click **OK**. The default location would be `%USERPROFILE%\netavisLibs`.
6. Click OK in the Environment Variables dialog window and close the other dialogs as well.

Working with sessions of pre-4.0 servers

The **Starter** also allows you to also manage sessions with Observer servers running releases older than 4.0. Just select the checkbox **Show settings for pre-4.0 releases** to show the additional settings.

Description of elements:

Element	Description
Window width, height	Define the size of the client window in pixels.
Upper left corner X, Y	Define the location of the upper left corner of the client window in pixels. This setting can be changed, e.g., for multi-screen setups.
Initial monitor view name	Is optional and defines the initial Online monitor view.
Window decoration visible	Defines whether the windows decoration border is visible.
Tool control bar visible	Defines whether the tool control bar at the right side of the window is visible. This bar allows switching between Online Monitor, Archive Player, Event Management and Administration.
Event bar visible	Defines whether the event bar at the bottom of the window is visible.
Online monitor control bar visible	Defines whether the  menu and the history buttons for Online monitor control are visible.
Overlay painting enabled	When this is selected and the hardware supports it the Online monitor uses the hardware overlay technique for displaying flicker-free MPEG streams. This can also boost the client performance and relieve the main CPU. In multi-screen operation, overlay painting of MPEG video streams may result in pink colored view ports if the client is not running on the primary screen of Windows. Then you should turn off this

Element	Description
	feature.

2.3 Client multi-window and multi-screen operation

Observer supports multi-window and multi-screen operation. With clients workstations that have multiple screens connected you can position windows on different screens.

Here is an example of a client setup with 3 screens:



The window contents and positions are automatically stored per user and between sessions. This means when a user has multiple windows positioned on 3 screens and he exits and then logs in again, all the windows on the 3 screens will automatically be restored.

Please note: There can only be one Archive player and this is located in the main window.

2.3.1 Creating a new window

In the main application window select **New window** from the **Windows** menu.



The window title and the contents of the window can be adapted in the **Client preferences** (see 2.4 *Client preferences* on page 19 for more details).

2.3.2 Modifying window layouts

You can modify the layout of a window by rearranging its components. Once you have defined in the **Client preferences** dialog what components are to be shown in a window you can customize the layout. Select the menu **Windows->Enable layout customization**. For the Event list and the Camera tree you can now define:

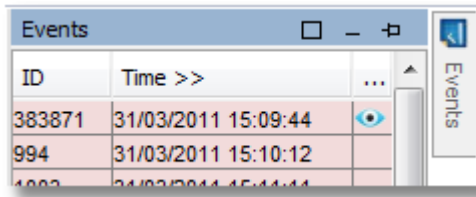
- Where they are located inside the window: Just click on the title bar of the Event list or the Camera tree and drag it to a different location. For example, when the Online monitor and the Event list are enabled, then you can drag the Event list from the default position at the right border of the window to the bottom of the window.



- Whether they are floating (open when needed or there are new entries and collapsed or hidden otherwise) or pinned (always shown): You can change the state of the Event list or the Camera tree by pinning  or unpinning  it in the title bar.

Whether the Event list or the Camera tree should fill the whole window: You can maximize the component by pushing the maximize button . When a component is maximized, it will occupy the whole space of the window and will automatically resize when you resize the window. Thus you can create a window that contains only an Event list.

After you are done with the modifications deselect **Windows->Enable layout customization**.

The default location for the Event list is the right window border and for the Camera tree (that usually only pops up when needed) it is the left window border.

Note: Only the Event list and the Camera tree can be dragged. The other components in the window will then change their size accordingly.

2.3.3 Positioning a window on a specific screen

Positioning a window on a specific screen is very easy: Use the mouse to drag the window to the desired screen and drop it there. You can also maximize the window on the screen.

When a window is configured to be in full screen mode (and therefore drag and drop is not possible) there is a **Send to screen** option in the context menu (accessible via a right mouse button click).

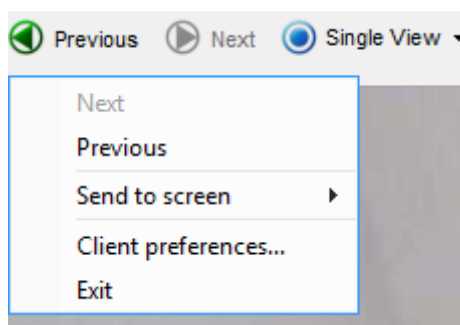

Note: See 2.4 *Client preferences* on page 19 for information on how to enable full screen mode for a window.

All the window states will be remembered between sessions. This happens on a per-user basis, which means when the user logs in on a different client workstation the same window setup as on the first client workstation will be shown.

2.3.4 Deleting a window

In the main application window select **Delete window...** from the **Windows** menu. A **Delete window** dialog will open, offering you the list of windows available for deletion.

2.4 Client preferences

The Observer client offers many configuration options which can be adjusted via the **Client preferences** accessible via the **Observer** menu or the right mouse click menu in the main application window.

Note: Depending on the authorization that your Observer administrator has assigned to you, some of the client components could be disabled (menu shown in grey color). If you need more authorization, please contact your local Observer administrator.

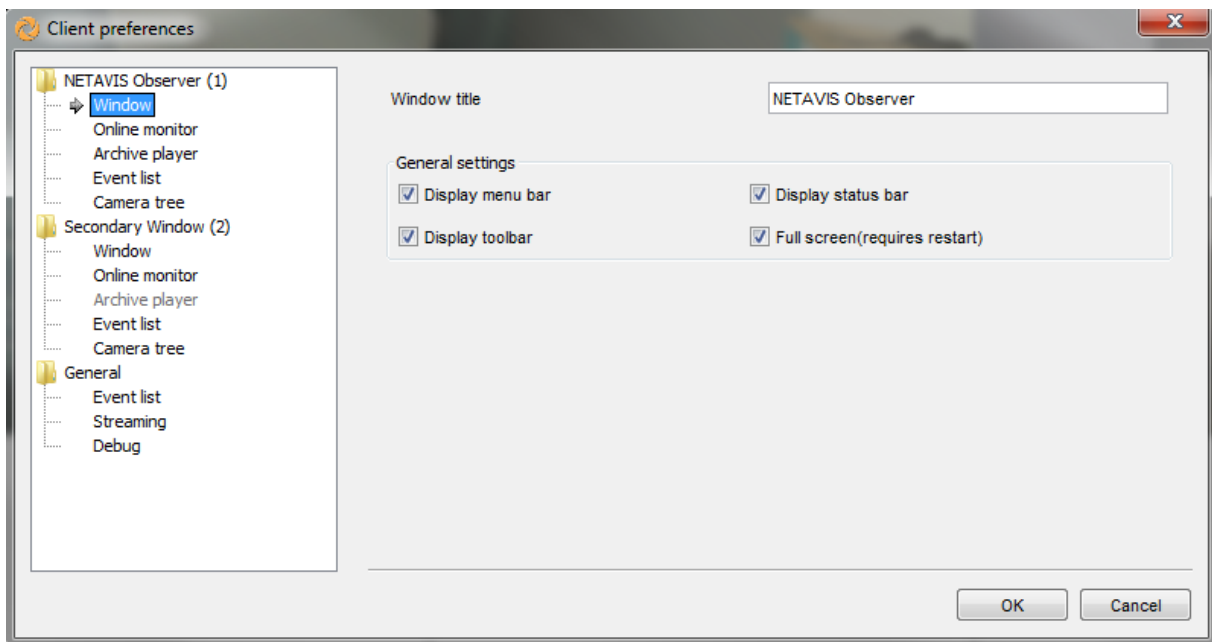

2.4.1 Window preferences

Here you can set some general configuration options for each individual window:

- The **Window title** is shown in a window's title bar. Note that the number in brackets after the window title in the left-hand menu is the ID of the window. That is important as only the main application window designated by **(1)** can contain the **Archive player**. Similarly the **Display menu bar**, **Display status bar**, and **Display toolbar** options are also only available for the main application window.
- The **Full screen (requires restart)** option is available for every window. In full screen mode a window is shown without a title bar or the Windows task bar and fills the whole screen.

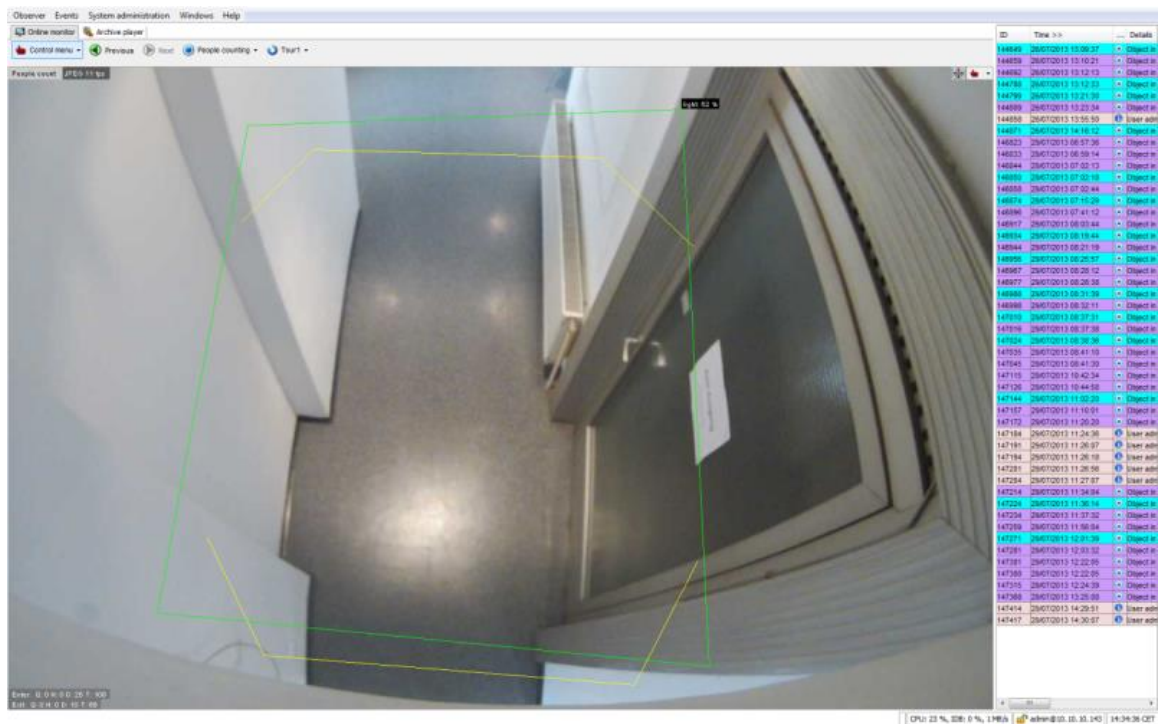

2.4.2 Defining which components to display in a window

For each window you can define any combination of components and component-specific configurations to be displayed:

- **Online monitor:** You can choose to **Display Online monitor** and **Show main controls** (the View control menu, Next and Previous buttons, View selector, and Round tour selector). For that Online monitor's empty view ports you can configure whether the **Add camera** button should **Show on mouse over** or else only be accessible via the right mouse click menu. The **Preferred monitor for large view on double click** option can only be set for one window and defines in which one big views of cameras are shown after a double click.
- **Archive player:** You can choose to **Display archive player**.
- **Event list:** You can choose to **Display event list**, **Display titlebar**, **Hide acknowledged events**, **Show hidden event list on new events** and **Scroll to reveal new events**. Additionally you can configure which columns to show in the event list: **ID**, **Time**, **Details**, **Camera ID**, **Camera**, **Priority**, **Icon**, **Server**, and **ACK state**.
- **Camera tree:** You can choose to **Display camera tree always** and **Display titlebar**.

Note: Normally it is not necessary to always display the camera tree since it is displayed on-demand. Also note that as of NetavisObserver 4.6.2 the state of the camera tree (which groups are and are not expanded) is stored per user.

2.4.3 General preferences

The configuration options set here apply to all Observer client windows:

- **General:** You can enable the **Camera status display** (see 4.4 *Checking the camera status* on page 41 for details).
- **Event list:** You can enable/disable the **Play event sound** option and configure the **Maximal event count** shown in the event list. It is also possible to configure the **Default event video**

export duration (how many seconds of the recording before and after the event should be exported) and **Override default archive playback duration** (how many seconds of the recording before and after the event should be shown per default in the archive player). This last option overrides other pre- and post-event recording options which may have been set up for specific events.

- **Streaming:** To ensure smooth video and audio playback you can configure the length of the local **Live video cache** (with and without audio) in milliseconds. In case of connectivity issues it is advisable to raise the **Live video cache (no audio)** value above the default of 200ms.
- **Debug:** You can enable different debug options and **Show Log Debug**.

Note: These debug options are only needed for advanced error diagnosis.

2.5 Mobile Observer clients

You can also access an Observer server from mobile devices such as smartphones and tablets. As of Netavis Observer version 4.8.0 the previously provided Client for iPad and Client for Smartphone & Tablet are deprecated and no longer supported. The new Mobile Client provides cross-platform support for all supported browsers and platforms. Please refer to the *NETAVIS Observer Server, Client and Storage Compatibility and Requirements* document for details on compatibility.

Note: These mobile clients do not support the full functionality of desktop clients (see *2.1 Introduction to Observer clients* on page 11 for more details). When using the Mobile Client the videostreams of cameras, which do not provide a MJPEG stream to the Netavis Observer server, have to be transcoded on the server which requires additional CPU power.

This chapter describes how to use these mobile Observer clients.

2.5.1 Mobile Client

The Mobile Client can be run directly in a web browser on a smartphone, tablet or PC and does not require any installation:

1. Start a web browser.
2. Enter the address of your Observer server followed by /mobile (e.g. **<Observer-IP>/mobile**) and login. Both **http** and **https** are supported by the Mobile Client.
3. If you have previously configured a view you will see it after logging in. Else you will be presented

with an empty view. Click on the menu button  and select **View Config** to create a view.

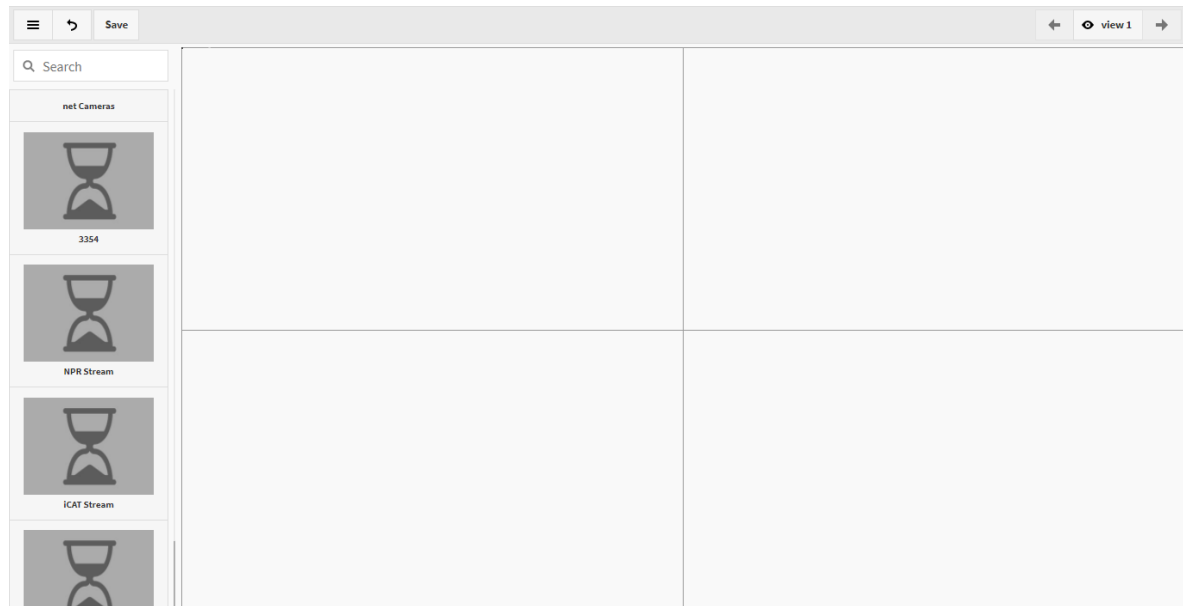

4. By clicking on the menu button again you can choose between different options:
 - **Leave view config:** Leave the view configuration
 - **Save:** Saves the current view configuration.
 - **Create new view:** Allows you to create a new view and configure it with a **Name** (with up to 20 characters), the desired number of view ports (max. 3x2) and the default fit mode (**Letterbox**, **Stretch** or **Crop**).
 - **View properties:** Allows you to change the currently selected view.
 - **Delete current view:** Deletes the current view.
 - **Logout:** Logs out of the Mobile Client.
5. To add a camera to a view port select it in the camera tree on the left-hand side and drag it into the desired view port. You can also search for cameras using the search box at the top.

Note: A preview of the camera image is only visible in the view configuration if the camera is configured to provide a MJPEG stream to the NetavisObserver server. In the actual view however the camera's stream will be shown regardless of the its codec.

6. Once you have added a camera you can change its view configuration by double-tapping on it. Changing its size allows you to have a camera fill multiple view ports. It is also possible to overwrite the view's fit mode with a camera specific one.
7. To remove a camera from a view port you can either select and drag it back to the camera tree or select **Remove camera** from the camera configuration.
8. After selecting **Leave view config** you will see the configured view:

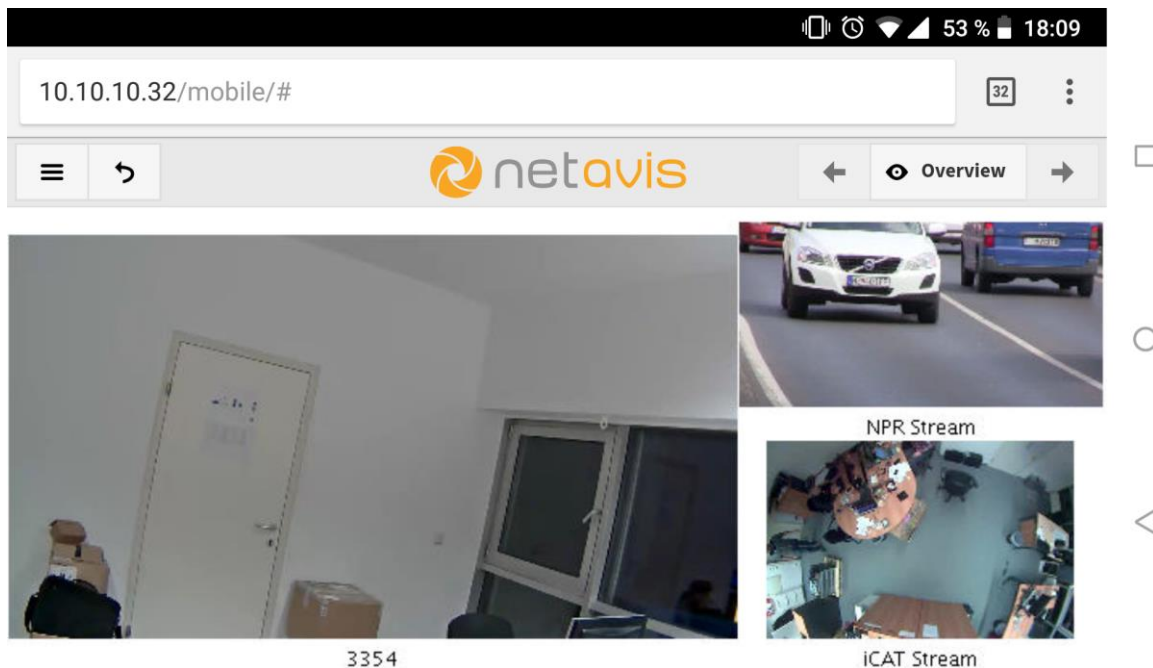

9. To switch between different views, you can either swipe left / right on touch-enabled devices or use the **View menu** in the top-right corner or move between views with the **Backward** or **Forward** buttons.

10. By tapping on a camera in a view it will be opened in a large view.

11. In a camera's large view you can select to play back archive recordings by tapping on the **Archive**

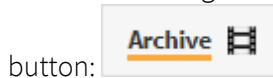

12. The playback can be started and stopped by clicking on the video and the usual playback buttons are available at the bottom. Additionally, there is a shortcut menu on the right which allows you to select the playback of different intervals, including a custom one where you can enter a specific timeframe for playback.

13. You can return to the large live view or to the view by clicking on the **Back** button:

14. To add the Mobile Client as a shortcut on your mobile device follow these steps:

- **Android / Chrome:**

- Open the Mobile Client in the Safari app
- Open Chrome's menu
- Press the **Add to Home Screen** button
- Enter a name for the shortcut and then press **Add**
- The shortcut then appears on your home screen:



- **iOS / Safari:**
 - Open the Mobile Client in the Safari app
 - Open Safari's **Share** menu and choose **Add to Home screen**
 - Enter a name for the shortcut and then press **Add**
 - The shortcut then appears on your home screen and can be used like with any other app
15. On PCs the Mobile Client also offers keyboard shortcuts for often used functions:
- **Application-wide:**
 - ENTER: Confirm action or dialogue
 - ESC: Dismiss popup
- Note:** Leads to a stop of the Mobile Client in Internet Explorer!
- q: logout
 - **Main view:**
 - e: jump to view configuration
 - left-arrow: jump to previous view
 - right-arrow: jump to next view
 - **Live/Archive view:**
 - left-arrow: jump to live view
 - right-arrow: jump to archive view
 - **View configuration:**
 - p: Show view properties
 - n: Create new view
 - DELETE: Delete view
 - l: Select *letterbox* in view / camera properties
 - s: Select *stretch* in view / camera properties

- *c*: Select *crop* in view / camera properties

2.5.2 Client for iPad (deprecated)

To get the Netavis Client for iPad follow these steps:

1. Follow [this link](#) or go to the iTunes Store and search for "NETAVIS".
2. Install the Observer app on your iPad.

To use the app:

1. Start the Netavis Client for iPad.
2. Connect to an Observer server and login.
3. If you have previously configured a view port layout you will see it and be able to tap on a camera for a full screen view and access to its archive:



Else you first have to tap **Add layout**, select the desired layout and then add cameras to the individual view ports. It is possible to add multiple layouts and switch between them using the arrow buttons or dropdown menu in the middle of the navigation bar:

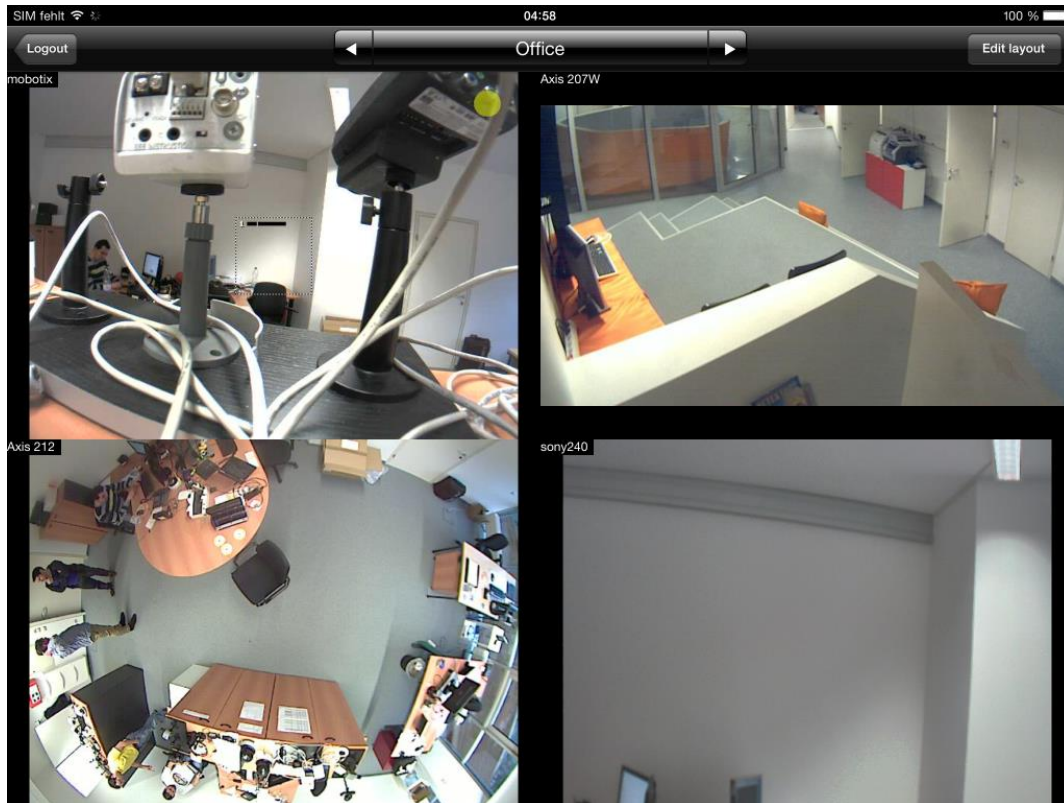

4. When you are finished using it, it is recommended to log out of the Netavis Client for iPad via the **Logout** button on the overview screen (although there is an automatic logout after 10 seconds).

2.5.3 Client for Smartphone & Tablet (deprecated)

The Client for Smartphone & Tablet can be run directly in a smartphone or tablet web browser and does not require an installation:

1. Start a web browser on your smartphone or tablet.
2. Enter the address of your Observer server followed by /browserclient (e.g. **<Observer-IP>/browserclient**) and login. Both **http** and **https** are supported by the Client for Smartphone & Tablet.
3. When you get the camera tree tap/click on camera groups to expand them and then on a camera to show its live stream:

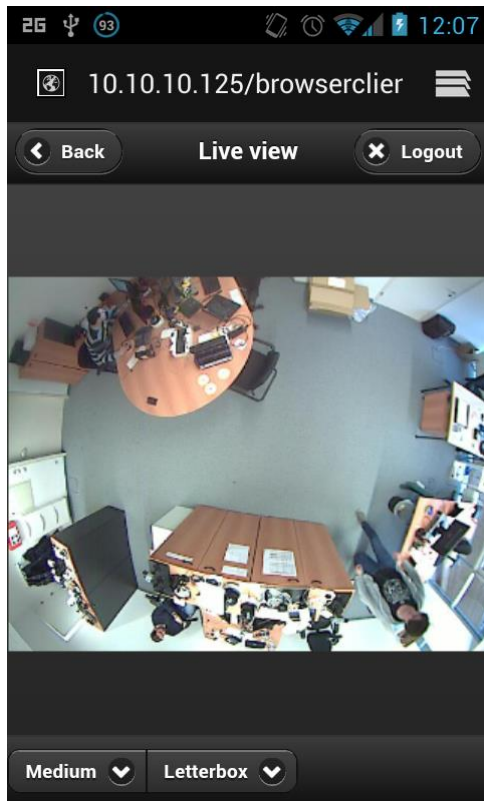

4. You can choose whether to watch the live-stream in a **Small, Medium or Large** resolution and which **Letterbox** mode should be used.

Please note: Changing the resolution only works for cameras where multiple MJPEG streams are supported. Please see the *Netavis Observer Supported Video Sources* document for further information.

5. When you are finished using it, it is recommended to log out of the Client for Smartphone & Tablet via the **Logout** button (although there is an automatic logout after 10 seconds).

2.6 Observer Transcoding for low-bandwidth client-server connections (ABS)

The unique Observer Transcoding technology (also called ABS for adaptive balanced streaming) reduces the necessary bandwidth for video streams to a fraction of the usual values. Especially high-resolution cameras can thus be streamed from server to clients over low-bandwidth wide area network (WAN) connections without loss of quality. Therefore even high-resolution cameras can be operated over very low bandwidth connections that would normally prevent their operation. The technology works for all cameras, streaming resolutions, and formats (including MPEG-4, H.264, H.265, and MxPEG).

Additional CPU resources are needed at the server and at the client for transcoding streams.

Transcoding can be set up in the server level by limiting bandwidth for live video and recording playback streams as well as for recording exports (see *11.2 Setting Observer server parameters* on page 109).

Note: ABS-Transcoding is only available in the Netavis Observer client and is not supported by the Mobile Client, Layout Navigation or other tools.

Hints: Although transcoding works with all streaming formats, the **best results and least CPU overhead** are possible with MJPEG streaming. Also the transcoding bandwidth limit must be chosen carefully.

Therefore **we suggest:**

- **MJPEG streaming format.**
- **Limit the transcoding bandwidth to app. 70% of the available server-client connection bandwidth.**

For connections, like Internet connections, with heavily varying bandwidth it is much better to use a lower limit than a higher limit. With low limits of 256 kbit/s or 128 kbit/s very good results are possible. Some customers have even used 56 kbit/s or 30 kbit/s with transcoding. As mentioned above the limits are defined in *11.2 Setting Observer server parameters* on page 109.

2.7 Exiting the client

The Observer client can be closed by choosing **Exit** from the **Observer** menu at the main application window. You will be asked whether you really want to exit.

If the menu bar is hidden, you can exit the client via the right mouse button menu.

3 Guidelines for setting up a new system with Observer

This section guides you how to best set up a new system with Observer. It shows which steps are needed in which order and gives you some hints on how to configure cameras and users.

For a **simple system with 1 server** take these steps:

1. Set up cameras
2. Set up users
3. Set up views

For a bigger **system with connected servers** take these steps:

1. Set up servers
2. Set up cameras
3. Set up users
4. Set up views

Please note: All of these steps should be taken by the administrator user (usually login **admin**).

Here we describe the steps for one server (for the setup of connected servers please see *12 Working with interconnected Observer servers* on page 117):

3.1 Guidelines for setting up cameras

Usually, a system consists of several cameras of the same type with similar settings. Bigger systems may have many cameras of the same type and several different types. Therefore, Observer offers you the possibility to duplicate cameras in order to facilitate the setup.

Take these steps for setting up cameras:

1. Define camera groups. We found that a good grouping criterion is the location of the camera. Another grouping criterion could be access rights for various user groups. See *4.6 Working with camera groups* on page 42 for details.
2. For each of the cameras that are of the same type and have a similar setting for recording and possibly motion detection create a camera that serves as a blueprint for other cameras and can be duplicated later.
Define also the recording settings for this camera. For motion detection (MD) take useful default values that can be tuned later on (please note that first you have to create the MD definition and then you set up the scheduling/recording for the MD setting).
Since most video analytics settings are different between cameras, it does not make a lot of sense to create default values for video analytics at this point in time. One exception could be that you may want to set up the same object tracking regions for several cameras.
For further details please refer to *4.2 Adding a new camera and basic configuration* on page 31 and *8 Working with motion detection* on page 86.
3. Now duplicate (clone) the cameras and, if necessary, move them to different camera groups.

After that you can fine tune the camera setup and define special settings like video analytics for various purposes (see *15 Video analytics with iCat* on page 142).

3.2 Guidelines for setting up users

Usually a bigger system will allow several users to login with different privileges and rights. Therefore it can be useful to group several users with similar tasks and rights in so called user groups in Observer.

Take these steps for setting up users and groups:

1. Create user groups for the various roles and privileges (examples are: security personnel, view only users, administrators). For each users group define the system wide privileges. See *5 Managing users* on page 44.
2. In the users groups create the users you need. Please note that by default the users will inherit the privileges from the group they belong to.
3. Set the camera access rights per user.

3.3 Guidelines for setting up views

Observer allows you create several views for showing cameras in various configurations and sizes. Therefore it makes sense to create various views for different surveillance purposes. Since the views are configured per user, we suggest that the administrator creates the standard set of views and then copies the views to the various users.

Take these steps for setting up views:

1. Create the various views needed by most users. See *6.1 Creating a new view* on page 54.
2. Copy the views to the various users. See *6.8 Copying views between users* on page 62.

Later on you can create further views and copy them again.

4 Setting up cameras

Netavis Observer allows any authorized user to set up cameras in the system.

4.1 Preparations

Before you begin to set up a new camera in Observer, be sure to have the following information available:

- Your camera model, its IP address, and its login information
- Whether your camera type is supported by Observer?
Please consult the document *Netavis Observer Supported Video Sources*.
- Are there available licenses for setting up additional cameras?

4.2 Adding a new camera and basic configuration

As of Netavis Observer 5.0 the **Camera Wizard** is the only way to add and manage cameras and it guides you through the configuration process. It is opened once a camera management option is selected in the **Camera admin** menu. On top of the usual manual configuration options, it provides:

- automatic camera discovery within an IP address range
- duplicating an existing camera and just modifying some parameters (see 4.2.2 *Duplicating an existing camera* on page 40)
- generating Excel template worksheets where cameras can be pre-configured (and subsequently imported into Netavis Observer)
- importing camera configurations from an Excel worksheet
- exporting the current camera tree into an Excel worksheet for documentation purposes

Hint: With Netavis Observer 5.1 the previously available **Camera admin** pages ("Default settings" and "Scheduling") have been replaced by the newly designed camera properties page, an enhanced camera wizard (details below), and Schedule Admin (see 21 *Schedule Admin* on page 187 for details).

4.2.1 Adding a camera from scratch

1. Choose **Camera admin** from the **System administration** menu. This opens the **Camera admin** dialog.
2. Select the camera group to which you want to add the new camera (later on you can move the camera in the camera tree to a different group) and choose **Add new camera** from the context-menu:

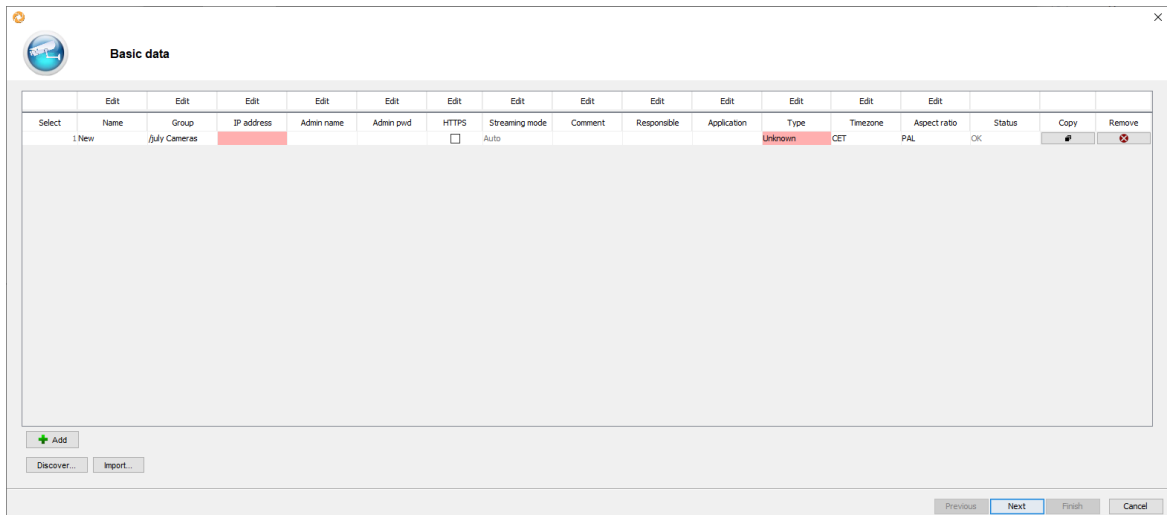

3. On this screen you can choose whether to manually **Add** cameras, use the **Discovery**, and/or **Import** cameras from an Excel file.
 - a. To manually add cameras, press **Add** to add a new camera entry and then skip to the next step.
 - b. To use the automatic camera **Discovery**, you are presented with a separate window where you can define the IP range for the automatic camera discovery. Discovered cameras are shown in the table below whereby the system also tries to assign the most appropriate camera type to it (e.g. if a camera is discovered as an ONVIF device and a device of vendor X the vendor X type will be used). They can then be added to the system by selecting them and pressing **Add selected**. Then continue with the next step.

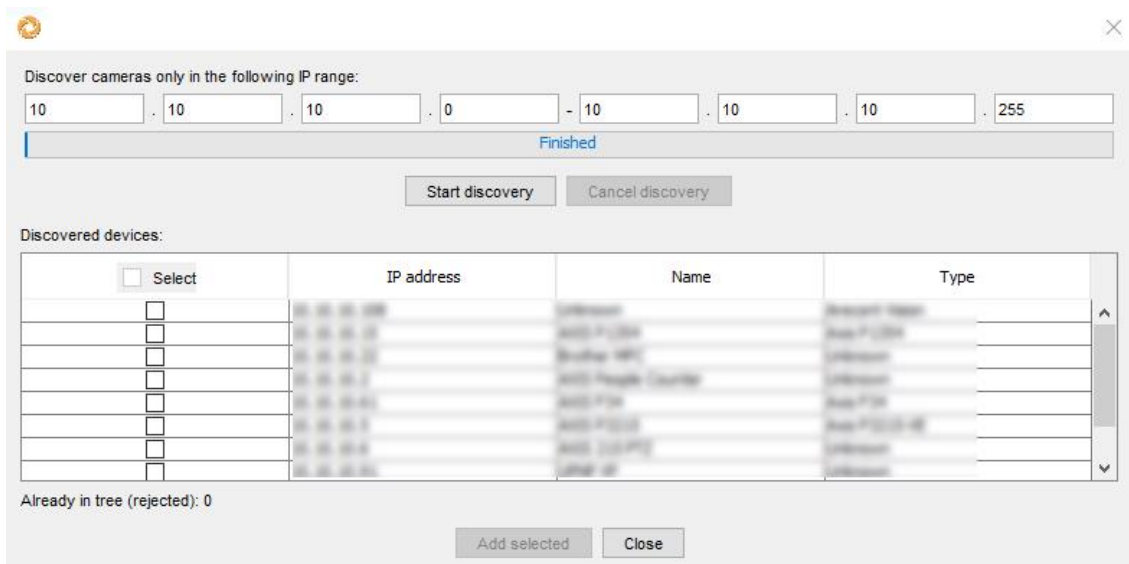

Note: Whether a camera can be found via the automatic camera discovery depends on many factors such as the camera model, camera configuration, network configuration, etc. If you cannot find a camera via the discovery, please try to add it manually. Also, note that cameras which are already configured in the system's camera tree or devices with more than one IP address are not shown in the table and will be counted in the **Already in tree (rejected)** field.

- c. To import cameras from an Excel file, press **Import**, select the prepared Excel file, and then continue with the next step.

Note: If a camera is listed multiple times in the Excel file then it will also be imported multiple times. However, if the Excel file contains a camera which is already configured on the system then it will not be imported again. Also note that import from an Excel file is only intended to be used for initial system setup and not for exporting an existing camera tree, modifying the configuration in Excel, and then re-importing the cameras.

- Regardless of how you added the cameras in the previous step, you now have to complete and verify their configuration. The first screen shows the cameras' **Basic Data** which can be sorted in ascending or descending order for every column by pressing on the column name. To make bulk modifications on this and any other pages select the desired cameras while keeping the CTRL key pressed and then click on **Edit** in the column that you want to modify (e.g. Type). You can also copy or remove an existing line by clicking on the **Copy** and **Remove** icons respectively. Additionally, cells marked in red indicate that part of the configuration is missing. Press **Next** when you are done with this part of the configuration to move to the next page.

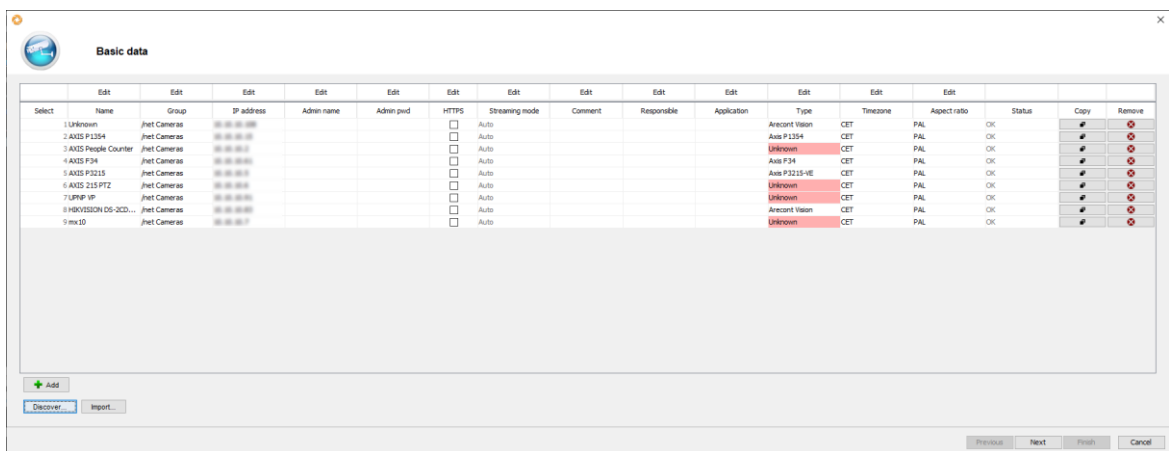

For the **Basic Data** fields labeled in **bold** are **mandatory** whereas all others are optional:

Field label	Description
Name	Enter the name that you want to give your camera. This is the name by which you will select or display this camera (e.g., "camera entrance").
Group	Select the group to which this camera should be added. Hint: It is also possible to select camera groups from other connected Netavis Observer systems. This allows you to add cameras from a NUS to a connected NCS.
IP address	Specify the IP address or network name of your camera or video server. If you supply a network name, you must have access to a domain name server (DNS) that resolves the name to an IP address. Even dynamic DNS names (like dyndns) can be used. This field is not needed for analog cameras connected directly via a video capture card (NDS).

Field label	Description
Admin name	<p>If the camera needs authentication for administration, then enter the user name of the camera administrator here.</p> <p>Note: Required for ONVIF Profile S cameras.</p>
Admin password	<p>Enter the password of the administrator account of the camera (up to 32 characters).</p> <p>Note: Required for ONVIF Profile S cameras.</p>
HTTPS	<p>If the camera supports encrypted streaming using HTTPS this setting will be enabled. It defines whether streaming from the camera is encrypted using HTTPS. Please note that encryption needs significantly more CPU resources on the server than unencrypted communication (see also <i>1.3 Observer data security</i> on page 7).</p>
Streaming mode	<p>This option is only enabled if the camera type is set to ONVIF - Profile S. Per default it is set to Auto but it can also be set to No tunneling, Multicast, RTSP tunneling or HTTP tunneling.</p>
Type	<p>Specify the camera type by selecting it from the camera pop-up menu.</p> <p>Important: If you want to connect an analog camera via a video server then select the type of the video server from the menu. If you connect an analog camera to a video capture card directly in the Observer server, then select NDS (Observer Digitizer Server) as your camera type.</p>
Time zone	<p>Select the time zone of your camera's location (e.g., CET for a camera installed in Vienna).</p>
Aspect ratio	<p>This setting is only enabled for certain IP cameras that are shipped with different aspect ratios (like PAL or NTSC). For cameras that are delivered in one standard only, the correct value is set automatically and cannot be changed. Please select the correct value for your camera. If you select a value that does not fit your camera, then the image might be distorted. Please refer also to <i>1.4.5 JPEG image sizes and storage requirements</i> on page 10.</p>

- If you have configured any of the cameras in the previous step to be of the **Type Axis - Generic**, **Hikvision - Generic**, **ONVIF - Profile S** or **VNS - Generic**, then the system will now fetch the cameras' capabilities which may take some time.

- If any of the added cameras have more than one channel (previously referred to as **Camera-server port**) or more than one view (e.g., 360° cameras often offer multiple views such as an overview, panoramic views, individual views for 90° perspectives, etc.) the next page allows you to configure them:

Field label	Description
Name	Here you can change the previously entered name of the camera's channels or views.
Group	Here you can change the previously selected group to which the camera's channel or view should be added.
Comment	Here you can add comments to the channel or view (up to 250 characters). Hint: To also show the comments in the camera tree press the Comment button next to the camera search field.
Channel	Here you can select a specific channel provided by the camera.
View	Here you can select a specific view provided by the camera.

Note: As of Netavis Observer 5.1 multi-channel cameras only require a single camera license.

- On the next page you can configure the **Further camera settings**:

Field label	Description
Comment	Here you can add comments to the camera (up to 250 characters). Hint: To also show the comments in the camera tree press the Comment button next to the camera search field.
Responsible	Here you can add the person responsible for the data processing required for GDPR documentation (up to 60 characters).
Application	Here you can add the data processing application required for GDPR documentation (up to 60 characters).
Use camera settings	This checkbox is automatically set depending on the selected camera driver and its corresponding configuration.

Field label	Description
Audio to camera	When marked, Observer will allow Audio to the camera and will offer a button for that in the Online Monitor . Of course, this feature only works if you have a working microphone connected to the PC where you run your client on and your camera has a loudspeaker function.
Audio from camera	When marked, Observer will allow Audio from the camera to your client (in the Online Monitor and for recordings). Of course, this feature only works if you have a working loudspeaker connected to the PC where you run your client on. Please note that platform restrictions may apply for this streaming mode (please refer to 2.1 <i>Introduction to Observer clients</i> on page 11).
Audio from and to share single button	If this checkbox is marked, then there is only one button in the Online Monitor that switches MPEG and Audio on and off. If this checkbox is not marked, then you will find 3 buttons for the three functions. See also 6.9 <i>Working with MPEG cameras and audio ()</i> on page 63.
Anonymize (distort) audio	In some cases laws do not allow the transmission or recording of people's voices. The criterion often is whether one can recognize a person by listening to its voice. Therefore Observer allows anonymizing the audio stream by distorting it. If this checkbox is marked then the live and recorded audio will be anonymized (distorted).

- On the next page you can configure the cameras' **Stream profile settings** which were introduced in Netavis Observer 5.1. You can use the **Add**-button to configure additional stream profiles for any cameras:

Field label	Description
Profile name	Enter the desired name of the stream profile and press ENTER to confirm it.
Codec	Select the desired codec of the stream profile whereby the possible values depend on the camera model.
Resolution	Select the desired image resolution of the stream profile whereby the possible values depend on the camera model. The higher the image resolution, the more bandwidth will be used for transmission and the more space for recording will be needed.
Frame rate	Select the desired frame rate of the stream profile whereby the

Field label	Description
	<p>possible values depend on the camera model.</p> <p>The higher the frame rate, the more bandwidth will be used for transmission and the more space for recording will be needed.</p>
Quality	<p>Defines the image quality of the stream profile. The possible values are High, Medium, and Low quality.</p> <p>The higher the quality, the more bandwidth will be used for transmission and the bigger the space requirements for recording will be (see also <i>1.4 Video streaming methods and compression</i> on page 7).</p>
Bandwidth (BW) limit	<p>This setting limits the maximum bandwidth in kilobits per second for the transmission of streams between the camera and the server. As a consequence, also the bandwidth between the server and the clients is thus limited and also the required storage in the archive is influenced (limited). If this value is zero, then the bandwidth is not limited.</p> <p>This actually is a setting in the camera. The camera always optimizes for the desired image quality and will sacrifice frame rate in favor of quality in the case, the bandwidth would exceed the supplied limit.</p>
GOP size	<p>For MPEG streams defines the how many frames are sent and stored in a GOP (group of pictures). One GOP is an integral data packet that is transmitted and recorded. Our default value is 10, which means that there is 1 reference frame (I frame) and 9 difference frames (P frames). A bigger GOP size means a higher compression rate but also a somewhat lower quality and a bigger delay between a real scene and its viewed images (which is relevant, e.g. for live viewing in the Online Monitor). We think that a GOP size of 10 is optimal for most case, which, dependent on camera model, covers a time between 0.5 ~ 1 sec.</p> <p>Note: With high bandwidth video streams (e.g. high resolution, high stream complexity) setting a large GOP size can have detrimental effects on the system performance and stability.</p>
RTSP port	<p>If you want to use the generic RTSP driver to get a stream from a camera - which requires selecting "Generic RTSP" as the camera's Type - then you have to enter the RTSP port of the camera into this field (if it is left empty then the default port 554 is used) and the specific URL into the field next to it (see below). The IP address, username, and password of the camera admin are used from the corresponding configuration made on the earlier Basic Data page. The stream configuration (stream resolution, fps, etc.) has to be done in the camera itself!</p>

Field label	Description
RTSP URL	If you want to use the generic RTSP driver to get a stream from a camera - which requires selecting "Generic RTSP" as the camera's Type - then you have to enter the RTSP URL of the camera into this field. The IP address, username, and password of the camera admin are used from the corresponding configuration made on the earlier Basic Data page. The stream configuration (stream resolution, fps, etc.) has to be done in the camera itself!

9. On the next page you can configure the cameras' **Archive settings**:

Field label	Description
Recording hours	Fill in the recording period for this camera. This value defines how long Netavis Observer will keep recordings. Recordings that are older than the recording hours will be automatically deleted by Netavis Observer. Note: As of Netavis Observer 5.1 the default recording period is 72 hours / 3 days (whereas it had previously been 720 hours / 30 days)!
Priority over other cameras (if storage space is short)	This option gives this camera priority over other cameras if the available storage space is too small for all requested recordings of all cameras (for further details see <i>7.1.4 Operation of the Observer dynamic storage management</i> on page 72).
Recording period is measured from...	This option defines what the requested recording period refers to: either Recording period is measured from now as calendar days or Recording period is measured from youngest recording as calendar days . There can be quite a difference between these two choices, e.g., a motion detection-based recording that only triggers recordings once every few weeks.

10. On the next page you can configure the cameras' **Schedule settings** whereby you can use the **Add**-button to configure additional schedules for the cameras:

Field label	Description
Type	Select the type of schedule: Continuous recording , Video analysis (iCat) , Camera MD (FTP) , PTZ route or Event-triggered recording
Scheduling	Select the default 24/7 schedule or a previously defined custom schedule (see <i>21 Schedule Admin</i> on page 187 for details).

Field label	Description
Enable	Set whether the schedule should be enabled or disabled.
Streaming profile	Select one of the previously defined streaming profiles.
Save Audio	Set whether the audio should be saved or not.
Frame rate	Taken from the selected streaming profile.
Pre-event recording (sec)	Definition of the pre-event recording period in seconds (only available for Video analysis (iCat) and Event-triggered recording schedules).
Post-event recording (sec)	Definition of the post-event recording period in seconds (only available for Video analysis (iCat) and Event-triggered recording schedules).
Assigned iCat definitions	Confirm the assigned iCat definitions to this schedule via the Assigned iCat definitions . Per default all available iCat definitions for this camera are assigned. If you do not want that you can remove them now by deselecting the definition(s) that you do not want included in this interval.
Store / display / propagate event	Set whether the events generated by this schedule should be stored in the system's database, displayed to the user in the event list, and propagated to connected Netavis Observer systems.
Routes	Assigned PTZ routes (only available for PTZ route schedules).

Note: It is not possible to define mixed recordings with different codecs for the same schedule or overlapping time frames (e.g., a 24/7 permanent recording in H.265 cannot be set up in parallel to a 24/7 iCat recording in H.264)!

11. Press **Finish** to save the configuration and return to the **Camera admin**.
12. By selecting a camera in the camera tree its entire configuration is shown on its **Properties** page:

4.2.2 Duplicating an existing camera

Duplicating an existing camera creates an exact duplicate of the camera with all settings except for the IP address copied. This is useful when you have more than one camera of the same type or with equal/similar settings (like recording or iCat video analytics settings). With duplicating a camera you can reduce the set up time for systems with many cameras with similar settings.

To clone an existing camera:

1. Choose **Camera admin** from the **System administration** menu. This opens the **Camera admin** dialog.
2. In the camera tree select the camera you would like to duplicate/clone.
3. Choose **Duplicate camera** from the menu.
4. The camera wizard opens with a duplicate of the previously selected camera.
5. Configure the duplicate's **Name** and **IP address** accordingly
6. Optionally modify other parameters as needed (see 4.2.1 *Adding a camera from scratch* on page 31 for details).
7. Press the **Finish** button at the bottom of the dialog when you're done.

Note: Only local cameras and remote camera groups can be duplicated. It is not possible to duplicate individually mounted remote cameras.

4.3 Setting up the camera recording archive

The configuration of camera recordings is covered in section 7.1 *Programming archive recordings* on page 72.

4.4 Checking the camera status

Netavis Observer offers a camera status overview which enables users to quickly see whether the cameras in their system or on connected remote servers are running normally. Issues such as a camera being unreachable are indicated by a red icon. An overlay provides additional information about each camera and its status and configuration.

In order for the camera status to be available the **Camera status display** option has to be enabled in the **Client preferences** (see 2.4 *Client preferences* on page 19 for details).

Note: The camera status overview is only updated for cameras which are being actively used by Observer for recordings, video analysis or live monitoring in the Online Monitor. For all other cameras the status is not updated.

Once the option has been enabled a status icon is added next to each camera and camera group in the camera tree within the **Camera admin**:

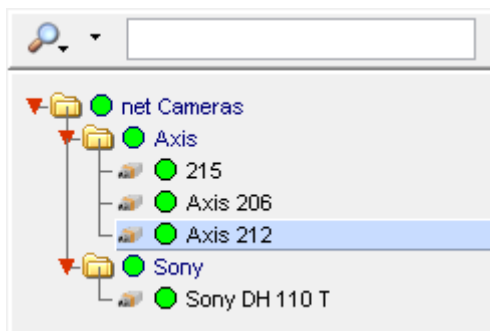

For cameras the status icon indicates one of three states:

- If the icon is green everything is running normally.
- If the icon is grey then the status is unknown or still being queried (please allow for up to a minute for the status to be determined).
- If the icon is red then one or more of the following issues have arisen:
 - Unreachable: The camera is not reachable (equivalent to the "Camera not responding" message in the Online Monitor's view port).
 - Authentication: The username and/or password in the camera setup are not correct (equivalent to the "Camera authentication error" message in the Online Monitor's view port).
 - Internal camera error: An internal camera error has occurred.

The status icon of a camera group is an aggregate of the statuses of its cameras. If one or more of the cameras have a grey or red status icon then the group's icon also has that color. This makes it possible to quickly get an overview of the cameras even when the groups aren't expanded:



More detailed information about each camera is available in an overlay which appears after hovering over a camera entry:

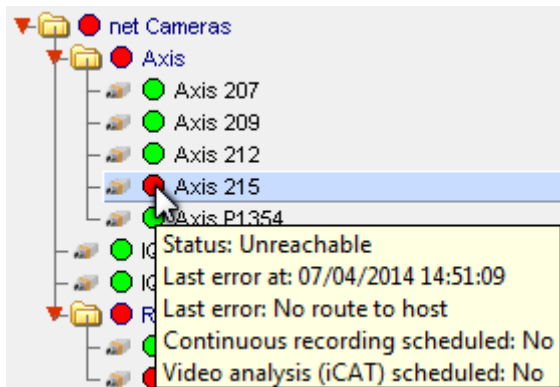

- Status: One of the first three error states described above or "Normal".
- Last error information: Includes the exact timestamp and a short description of the last error.
- Continuous recording scheduled: If a recording is scheduled to run on the camera at this point in time.
- Video analysis (iCat) scheduled: If an iCat definition is scheduled to run on the camera at this point in time.

4.5 Optional: Configuring video analytics (iCat)

The configuration of video analytics with iCat is covered in chapter *15 Video analytics with iCat* on page 142.

4.6 Working with camera groups

Camera groups are a powerful means for managing and organizing cameras.

4.6.1 Creating a new camera group

1. Choose **Camera admin** from the **System administration** menu. This opens the **Camera admin** dialog.
2. In the camera tree select the group in which you want to create the new camera group.
3. In the menu select **Add new camera group** which will open new dialog that allows you to enter the name and description for the new camera group.
4. Optionally select the **Use group name as camera name qualifier** checkbox. If this checkbox is selected then the name of the camera group is displayed as prefix to the camera name, e.g. "group-name:camera-name".
5. Press **Save** to create the new camera group.

4.6.2 Moving a camera or camera group in the camera tree

Individual or multiple cameras or groups in the camera tree can be moved to another location by following these steps:

1. Choose **Camera admin** from the **System administration** menu. This opens the **Camera admin** dialog.
2. With a mouse click choose the camera or group you want to move. To select multiple cameras or groups keep the CTRL key pressed while you make the selection.
3. In the menu select **Move camera or group**. A new dialog appears that requires you to enter the password.
4. Enter the password. After you enter the correct password a camera group dialog is opened showing the camera groups.
5. In the newly opened camera groups dialog select the group where you want to move the camera or group to and press **Select**. Now the cameras or groups are moved to the new location and the camera tree is updated.

4.6.3 Modifying cameras in a group

Using the **Modify cameras in group** menu-item it is possible to modify all cameras in a group or multiple selected cameras in different groups (press CTRL to select multiple cameras at once).

4.7 Changing the port mapping of analog cameras

This section is only valid for analog cameras. For analog cameras a port must be defined where the camera is connected to at the video capture card or the video server.

Sometimes the port mapping of analog cameras needs to be changed but it is difficult to do that physically by changing the cabling. To help the situation, Observer can change the port mapping in the software.

There are two ways for doing that:

- Either go to the **Camera Administration** and manually switch the port there. For this however you need to know exactly which camera is connected to which port.
- You can also swap the ports in the **Online Monitor**. This has the advantage that you see the video pictures and therefore you can identify the correct ports visually.

In order to swap the ports of two analog cameras visually please follow these steps:

1. In the **Online Monitor** go to the view that shows the first analog camera in a view port.
2. CTRL-click into the view port that shows the first analog camera.
3. Now go to the view that shows the camera that you would like to swap with and CTRL-click in the view port.

Now the ports of the two cameras have been swapped.

5 Managing users

Observer requires users to login in order to work with the system. This chapter describes how to create and manage users in Observer.

Generally, you can either

- use Observer to administer users (see *5.1 Creating a new user account* on page 44), or
- use Active directory or LDAP to manage users (see *5.8 Working with Active Directory and LDAP users* on page 53).

5.1 Creating a new user account

An Netavis Observer administrator can create user accounts in the system.

Note: At initial product installation a set of predefined users accounts and groups are created. These users and groups model typical permissions of users in various roles. Instead of creating a new user account you can take one of these predefined users and modify the settings accordingly. Also, ensure to delete the default users that are not needed on the system!

Here are the steps for creating a new user account:

1. Choose **User admin** from the **System administration** menu. This opens the **User admin** dialog.
2. Select a user group to which you want to add the user. Please refer to *5.4 Working with user groups* on page 52 if you want to create a new user group first.
3. In the menu select **Add new user**. The **Properties** dialog opens to allow you to enter user data.
4. Enter your user data in the corresponding fields of the dialog. Use the following table as a guide. Fields labeled in **bold** (both in the dialog and in the table) are **mandatory**; all others are optional:

Field label	Description
Login name	This is a short name that the user will use to log in.
Full user name	This is the complete name of the user.
Password	Enter a password for the user (with up to 32 characters). The user can change this later on (see <i>5.7 Changing the password</i> on page 53).
Re-enter password	Enter the password again for verification.
Secondary password	Enable the checkbox and enter a secondary password if a secondary password is needed for logging in the user. This is important for enforcing the four-eyes-principle for certain video operations.

Field label	Description
Re-enter sec. password	Enter the secondary password again for verification.
Change password	Interval in which the user has to change the password: 1 month, 3 months, Never
Forgot question	Formulate a question that (only) the user can answer if he has forgotten his password.
Forgot answer	Provide the answer to the above password question.
Enable web customizer login	<p>Defines if the user has access to the Customizer on the server's web page where system backups, configuration files, custom event handlers, and other advanced administration tools are available.</p> <p>Hint: As of NetavisObserver 5.1 this option can also be configured for Active Directory users.</p>
Enable download of exported files	<p>Defines if the user has access to the automatically exported files on the server's web page (see <i>19 Automatic Export</i> on page 181 for details).</p> <p>Hint: As of NetavisObserver 5.1 this option can also be configured for Active Directory users.</p>
E-mail address	If the user is to receive an e-mail in the event of an alarm or failure, provide his e-mail address.
Language	<p>Specify the preferred language for this user.</p> <p>Hint: As of NetavisObserver 5.1 this option can also be configured for Active Directory users.</p>
Auto login after 1 min timeout	Defines whether this user should be logged in automatically when nobody else logs at the login panel in for 1 minute. This option can be enabled for only one user at a time.
Ask for login reason	<p>If this option is enabled, then the user has to document a reason for the login at the system.</p> <p>Note: If the global Ask for login reason option is enabled in the Host Admin then the user-specific setting is ignored.</p>

Field label	Description
PTZ priority (1=lowest, 10=highest)	<p>Defines the relative PTZ priority between users. A user with higher priority can take away PTZ control from a user with lower priority.</p> <p>Note: The automated PTZ actions started by the event manager and scheduled routes have priority 4. Therefore users with priority 1 to 3 will be overridden by automatic PTZ actions, whereby users with priority 5 to 10 can override automatic PTZ actions but will not be interrupted by them.</p> <p>Hint: As of Netavis Observer 5.0 it is also possible to modify the PTZ privileges of Active Directory users.</p>
Max. PTZ use time (sec)	<p>Maximum allocation time, after which a PTZ camera is automatically released. Zero means no limit.</p> <p>Hint: As of Netavis Observer 5.0 it is also possible to modify the PTZ privileges of Active Directory users.</p>
PTZ inactivity timeout (sec)	<p>When a user has taken PTZ control and is inactive for a certain amount of time, the PTZ camera is freed automatically after this timeout. Zero means no timeout.</p> <p>Note: As of Netavis Observer 5.0 it is also possible to modify the PTZ privileges of Active Directory users.</p>

5. Click on **Next** to go the **Privileges** dialog. Here you can set the privileges for the new user (see *5.2 Setting general user privileges* on page 46 for details).
6. Click on **Next** to go the **Camera Access Rights** dialog. Here you can set the camera access rights for the new user (see *5.3 Setting camera access rights* on page 50 for details).
7. Click on **Save** to create the new user account with the settings you entered.

Hints: In order to use the four-eyes-principle you first create a user with the desired privileges and camera access rights. You then create a new user, set a secondary password for that second user, grant the same privileges and camera access rights as the first user, and then add the desired additional rights (e.g. Archive access) compared to the first user.

5.2 Setting general user privileges

For each user and group certain privileges can be defined. These privileges define which tools and data a user has access to and what he can do.

1. Choose **User admin** from the **System administration** menu. This opens the **User admin** dialog.
2. Search for the user or directly select the specific user or group you want to modify.

- Click on the **Next** button to move to the **Privileges** dialog.

Here you can edit privileges for the user or group. In their initial state, all privileges in this dialog are inherited from the upper group level. Inherited privileges from the group level to which the user or group belongs are displayed with normal font, while values that you define at the current user or group level are displayed in **bold**.

Use the scroll bar to access the lower part of the list.

- Choose **Modify selected user or group** from the menu.
- Set the privileges according to your needs. To change a privilege click on its button and select the status from the pop-up menu (either **Inherited**, **Enabled**, or **Disabled**):

Field label	Description
Online monitor: Access to Online monitor	Defines if the user/group has access to the Online monitor
Online monitor: Add cameras to views in Online monitor	Defines if the user/group can add cameras to existing views in the Online monitor
Online monitor: Remove cameras from views in Online monitor	Defines if the user/group can remove cameras from existing views in the Online monitor
Online monitor: Create and delete views in Online monitor	Defines if the user/group can create and delete views in the Online monitor
Online monitor: Save view layouts in Online monitor	Defines if the user/group can save different view layouts in the Online monitor
Recordings: Access to recording archive player	Defines if the user/group can access the recording archive
Recordings: View external archive recordings (NEA)	Defines if the user/group can view NEA recordings
Recordings: Manage external archive devices (NEA)	Defines if the user/group can manage external storage devices for NEA
Events: Access to Event list and database	Defines if the user/group can access the Event list and database
Events: May acknowledge a system event	Defines if the user/group can acknowledge system events
Events: Notification in user interface	Defines if the user/group receives notifications about

Field label	Description
about system malfunction events	system malfunction events within the client
Events: Sending email about system malfunction events	Defines if the user/group receives notifications about system malfunction events via email
Events: Sending SMS about system malfunction events	Defines if the user/group receives notifications about system malfunction events via SMS
Events: Notification in client user interface about system information messages	Defines if the user/group receives notifications about system information messages within the client
Events: Sending email about system information messages	Defines if the user/group receives notifications about system information messages via email
Events: Sending SMS about system information messages	Defines if the user/group receives notifications about system information messages via SMS
Events: Notification in user interface about I/O device malfunction events	Defines if the user/group receives notifications about I/O device malfunction events within the client
Events: Sending email about I/O device malfunction events	Defines if the user/group receives notifications about I/O device malfunction events via email
Events: Sending SMS about I/O device malfunction events	Defines if the user/group receives notifications about I/O device malfunction events via SMS
Events: Notification in user interface about I/O device port value change events	Defines if the user/group receives notifications about I/O device port change events within the client
Events: Sending email about I/O device port value change events	Defines if the user/group receives notifications about I/O device port change events via email
Events: Sending SMS about I/O device port value change events	Defines if the user/group receives notifications about I/O device port change events via SMS
Events: Notification in user interface about external data sensor malfunction events	Defines if the user/group receives notifications about external device malfunction events within the client
Events: Sending email about external	Defines if the user/group receives notifications about external device malfunction events via email

Field label	Description
data sensor malfunction events	
Events: Notification in user interface about external data sensor events	Defines if the user/group receives notifications about external device events within the client
Events: Sending email about external data sensor events	Defines if the user/group receives notifications about external device events via email
User admin: Access to User administration	Defines if the user/group has access to the User admin configuration
User admin: Manipulate user data	Defines if the user/group can change the User admin configuration
User admin: Access to information about logged-in users	Defines if the user/group can access the Users tab to see which other users are logged into the system
Camera admin: Access to camera admin	Defines if the user/group has access to the Camera admin configuration
Camera admin: Manipulate camera configuration data	Defines if the user/group can change the Camera admin configuration
iCat: May set iCat definitions read-only	Defines if the user/group can set iCat definitions read-only
iCat: Reset heat map values manually	Defines if the user/group can reset heat map values manually
I/O device admin: Access to I/O device admin	Defines if the user/group has access to the I/O device admin
I/O device admin: Manipulate I/O device configuration data	Defines if the user/group can change the I/O device configuration
Rule Admin: Access to rule administration	Defines if the user/group has access to the Rule administration
Rule Admin: Manipulate rules	Defines if the user/group can change the Rule configuration
Automatic Export: Access to automatic exports	Defines if the user/group has access to the Automatic export administration

Field label	Description
Automatic Export: Manipulate automatic exports	Defines if the user/group can change the Automatic export configuration
External device admin: Access to device admin	Defines if the user/group has access to the External device administration
External device admin: Manipulate device configuration data	Defines if the user/group can change the External device configuration
Host admin: Access to Host administration and System information	Defines if the user/group has access to the Host admin configuration and System information
Client: Allow GUI layout customization	Defines if the user/group can customize the layout of the Client
Client: Allow window management	Defines if the user/group can create and delete windows
Client: Manage number plate lists	Defines if the user/group can manage number plate lists
Client: Modify client preferences	Defines if the user/group has access to the client preferences
Client: Allow saving logfiles	Defines if the user/group can download the logfiles from the server

To set privileges for all users in the system you can select and modify the root group (but please be aware that at each group or user level privileges can be overridden).

6. Click **Save** to save your changes.

5.3 Setting camera access rights

1. Choose **User admin** from the **System administration** menu. This opens the **User admin** dialog.
2. Select the user or group you want to modify.

Please note: The camera access rights can be set for regular individual users and Active Directory groups but not for regular user groups or individual Active Directory users.

3. Click the **Next** button twice to get to the **Camera Access Rights** dialog.

As with the general user privileges also the camera access rights are initially inherited from the upper group level. Inherited camera access rights from the group level to which the user or group

belongs are displayed with normal font, while values that you define at the current user or group level are displayed in **bold**.

4. Select the camera or camera group you want to look at or modify.
5. Choose **Modify selected user or group** from the menu.
6. Set the rights according to your needs. To change a camera access right click on its button and select the status from the pop-up menu (either **Inherited**, **Enabled**, or **Disabled**):

Field label	Description
Live viewing: View live streams in the Online monitor	Defines if the user/group can view live streams in the Online monitor.
Recordings: Access camera recording archive	Defines if the user/group can view the camera recording archive.
Recordings: May export camera archive recordings	Defines if the user/group can export archive recordings.
Recordings: May protect archive against deletion	Defines if the user/group is required to enter a reason for accessing an archive recording which is stored on the system.
Recordings: Ask user for reason of accessing the archive recordings	Defines if the user/group is required to enter a reason for accessing an archive recording which is stored on the system.
Recordings: Manual recording control in Online monitor	Defines if the user/group is able to manually start and stop recordings in the Online monitor.
PTZ control (pan, tilt, zoom) and I/O port control	Defines if the user/group is able to manually control PTZ cameras and set I/O ports.
Camera admin: Manipulate camera or group configuration data	Defines if the user/group is able to modify the configuration of cameras and camera groups.
Events: Notification in client user interface about camera malfunction events	Defines if the user/group is notified about camera malfunction events in the client.
Events: Sending email about camera malfunction events	Defines if the user/group is notified about camera malfunction events via email.
Events: Sending SMS about camera malfunction events	Defines if the user/group is notified about camera malfunction events via SMS.

Field label	Description
Events: Notification in client user interface about in-picture events (e.g. motion detection, video analysis)	Defines if the user/group is notified about in-picture events in the client.
Events: Sending email about in-picture events (e.g. motion detection, video analysis)	Defines if the user/group is notified about in-picture events via email.
Events: Sending SMS about in-picture events (e.g. motion detection, video analysis)	Defines if the user/group is notified about in-picture events via SMS.

To set access rights for the selected user for all cameras in the system you can select and modify the root camera group.

7. Click **Save** to save your changes.

5.4 Working with user groups

User groups are a powerful means to manage and organize users. For instance, you can set privileges for groups that are then inherited by the users belonging to this group.

5.4.1 Creating a user group

1. Choose **User admin** from the **System administration** menu. This opens the **User admin** dialog.
2. In the list of users and groups, select a user group to which you want to add a new group.
3. In the menu select **Add new group** which will open the new group dialog that allows you to define a **Group name**.
4. Press Next to edit the group **Privileges**. The privileges are the same as for a user. Inherited privileges are displayed in normal font while privileges defined at this group (level) are displayed in bold font.
5. Press **Save** to create the new group.

5.5 Defining Online Monitor views for a new user

If a new user needs to work in the Online Monitor then camera views need to be defined. Generally, there are 2 ways for doing that:

- Login as the new user and manually create new views as described under *6.1 Creating a new view* on page 54, or
- copy existing views from another administration user as described under *6.8 Copying views between users* on page 62.

5.6 Information about logged-in users

Observer allows you to get information about logged-in users:

1. Choose **Users...** from the **System administration** menu. Now you see the list of logged-in users with information about the host from which the user logged in, login time, total bytes transmitted since login, and bandwidth.

5.7 Changing the password

This section describes how to change passwords for users defined in Observer. For users defined in Active Directory/LDAP, the passwords need to be changed there.

Each Observer administrator with the appropriate privileges can change the passwords of other users (see also *5.1 Creating a new user account* on page 44).

Additionally, each user can change his own password by following these steps:

1. In the **Observer** menu choose **Change password...**
2. In the newly opened dialog enter the old (current) password and the new password twice.
3. Push **OK** to change the password. When you login the next time, you will have to enter the new password.

Please note: The optional secondary password can only be changed by an Observer administrator with the appropriate privileges.

5.8 Working with Active Directory and LDAP users

The configuration of Observer to work with users from Active Directory and LDAP is covered in chapter *13 Active Directory Integration* on page 124.

Note: Active Directory usernames are not case-sensitive.

6 Using the Online Monitor

In the **Online Monitor** you can view live streams from cameras that are set up at the Observer server. The prerequisite is that you must have authorization to access the Online Monitor (see 5.2 *Setting general user privileges* on page 46). Furthermore, you can access only those cameras for which you have access rights (see 5.3 *Setting camera access rights* on page 50).

When a new user logs in the first time he will encounter an empty Online Monitor waiting for new camera views to be defined. Once you have defined your views they will reappear next time you log in.

You can also have several Online Monitors in multiple windows (see 2.3 *Client multi-window and multi-screen operation* on page 17).

Important: If you are using a low-bandwidth connection between client and server (e.g. via wide area networks) it can happen easily that the video streams cannot pass through the connection fast enough, which results in bad frame rates and slow responsiveness of the client. In such a case you should use the Transcoding feature of Observer. See 2.6 *Observer Transcoding for low-bandwidth client-server connections (ABS)* on page 27 for further details.

6.1 Creating a new view

Observer lets you create an unlimited number of named views. Each of these views can contain up to 100 camera view ports.

1. Choose **Create new view** (either from the empty Online monitor or from the **Control menu**) to open the **Create new view** dialog.
2. You can now choose the layout for your view from predefined templates and you also can define an arbitrary matrix of up to 10 x 10 views. A new dialog is opened asking for the name of the view and the aspect ratio for the view ports.

The **Name of view** is shown in the view selector at the top of the screen. Please note that you can also create a view hierarchy by using a colon between the names. In the example below we created a view in the group called “First floor” with a name “Entrance hall”. There might also be a view called “Office 1” or “Kitchen”.

The **Aspect ratio** pop-up defines the aspect ratio of the view ports in the view:

- o Fixed aspect ratios: PAL, NTSC, VGA, double VGA, or HDTV 16:9.
- o **Fill available space:** This is the default setting and will adapt the view port size (and hence the aspect ratio) to fill the available space.
- o **Custom aspect ratio:** here you can freely define an N:M aspect ratio.

The setting **Stretch image to fit into view port** (selected by default) defines whether a camera image can be stretched to fit into the view port. This may cause distorted images for aspect ratios that do not fit the current view port aspect ratios.

The setting **Crop image to fit into view port** defines whether a camera image can be cropped to fit into the view port. This may cause that some parts of the image are not visible in the view port. In the section 6.4 *Modifying view port settings* on page 57 you can define what part of the cropped camera image is to be shown in the view port.

Please select an aspect ratio that fits most of your cameras you plan to show in the view.
 Selecting an improper aspect ratio can lead to unused space on the screen.

Press **OK** to create a new view with these settings.

- In accordance with the selection above, Observer creates a new view that might look as follows (your view may have a different number of view ports depending on what you selected):

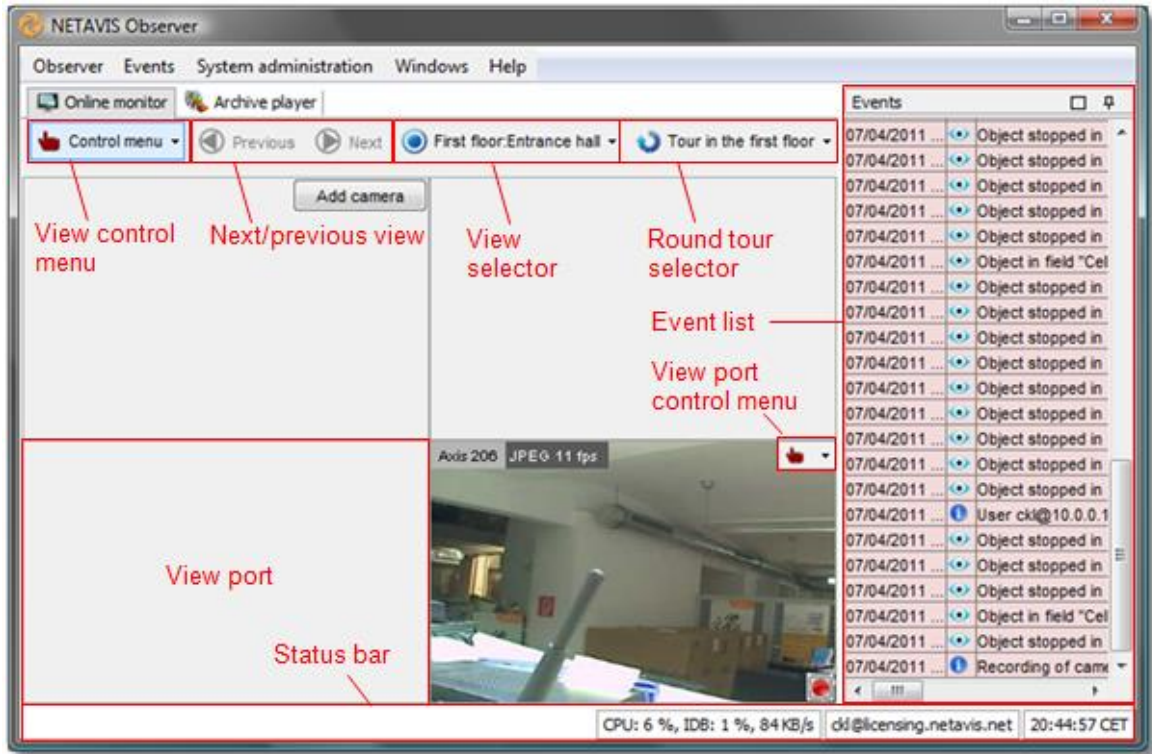

The view ports fill the central part of the window, and each view port has its own view port controls.

At the right side of the window is the **Event list**, which is explained in 9 *Handling events* on page 92.

- Choose **Save all view settings** from the menu in order to save all settings for your current user. The next time you log on to Observer, all views will then be available again. If you neglect to save, all changes are lost when you exit the application.
- You can change the name of the current view with **Rename view** in the **Control menu**.

Please note: All view settings will be stored, also image quality and frame rate settings of view ports. New views will be stored automatically without the need to save manually.

6.2 Selecting cameras

- In the view port press the **Add camera** button. Please note that you first have to set up a camera before you can select it in one of the view ports (see 4 *Setting up cameras* on page 31). This opens the camera tree.
- Select a camera from the camera tree.

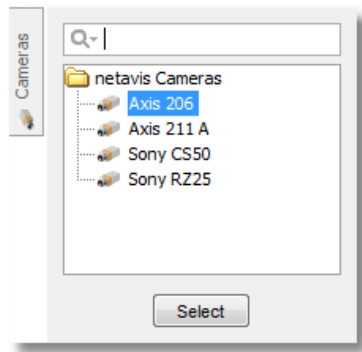

You can either:

- o select a camera and press the **Select** button, or
 - o double click on a camera to add it to the view port where you press **Add camera**, or
 - o drag and drop a camera to the view port of your choice
3. Proceed in the same way with additional view ports in your view.
 4. You can assign multiple cameras to each view port. However, since you can only view one camera image in each view port, Observer lets you manually switch between cameras by clicking on the camera selection menu at the upper left corner of the view port.

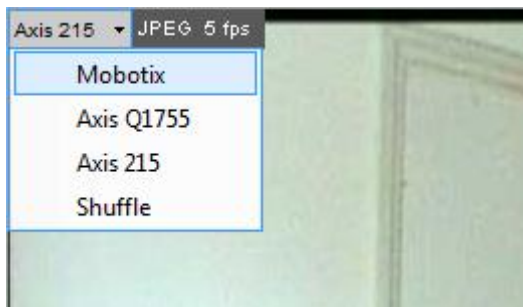

5. In the camera selection menu of a view port you can also select the option **Shuffle**. Then Observer cyclically switches through all the cameras assigned to the view port.
6. Please select **Save all view settings** from the view **Control menu** in order to save all settings. The next time you log in to Observer, all views and view ports will be available again.

6.3 Navigating in the Online Monitor

You have several options for navigating in the Online monitor:

- Select a view from the **View** dropdown menu.
- Select a Round tour from the **Round tour** dropdown menu.
- Use the **Next/Previous view** buttons or the corresponding options in the context menu (accessible via a right mouse button click) to navigate to the previously displayed views.

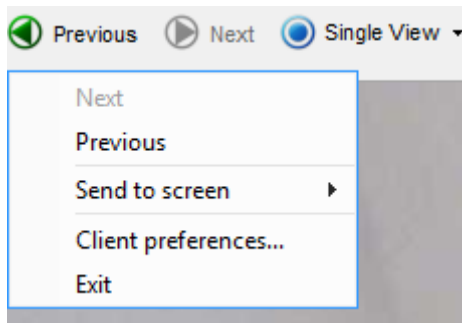

- Double click in a view port to get a big view of the currently displayed camera in the view port. If there is a view defined containing a big view port with the camera, then this view will be shown. Otherwise a new temporary view with the camera will be created. You can then go back to the previous view with the **Previous view** button or the corresponding option in the context menu. Please see below for a few hints on how to manage big views of cameras.

6.3.1 Optimizing big views of cameras (views opened after a double click)

When you double click on a view port with a camera then Observer does the following:

1. It first tries to open up an already existing big view that contains the camera, or
2. If such a view does not exist, a new temporary view will be created. For the new view some parameters such as the frame rate will be taken from the corresponding camera's default configuration whereas the following parameters are inherited from the view port it is derived from:
 - Video stream type (MJPEG, MPEG-4, H.264 or MxPEG)
 - Aspect ratio, incl. different custom aspect ratios
 - Crop or stretch parameters
 - Current crop position iCat
 - view options

Note: The new big view only inherits these parameters upon its initial creation. Subsequent changes made in the original view port (e.g. video stream type or iCat view options) will not affect the big view.

To create a permanent big view for a particular camera: **Create a view** with this camera and adapt the settings (see 6.1 *Creating a new view* on page 54 for details). Then a double click will open that view. You can group those big camera views into view groups by supplying view group names such as "Big:cam1", "Big:cam2" and so on.

6.4 Modifying view port settings

Netavis Observer allows you to set various options including video quality of either single view ports or all view ports in the current view at once.

The settings of a single view port can be modified via the view port's control menu  that appears in the upper right corner of a view port when you move the mouse pointer over the view port.

The view port control menu offers the following options:

6.4.1 Adding and removing cameras

Cameras can be added and removed with the **Add camera** and **Remove camera** menu entries. Please refer to section 6.2 *Selecting cameras* on page 55 for more details.

6.4.2 Controlling PTZ cameras

The **PTZ** menu allows PTZ control and is enabled for PTZ cameras (see 10.4.1 *Controlling PTZ cameras in the Online Monitor* on page 101).

6.4.3 Set stream profile

The **Set stream profile** menu allows you to select which of the previously defined stream profiles should be shown in the view port. This setting can also be modified for all view ports in the current view via **Set parameters of all view ports** from the **Control menu**.

Note: When modifying all view ports at once the selected options are only set for the view ports with cameras which support the desired options.

6.4.4 Controlling video analysis (iCat) display

The iCat menu offers various options for displaying iCat-related video analysis information. Please refer to 15.4 *Working with iCat* on page 164 for further information.

6.4.5 Replaying archived images

The **Replay archived images** menu offers the option to directly jump into the Archive Player to replay the previous 10 minutes, 1 hour, 24 hours or 1 week of recordings of that camera. An error message is displayed in case no such recordings are available.

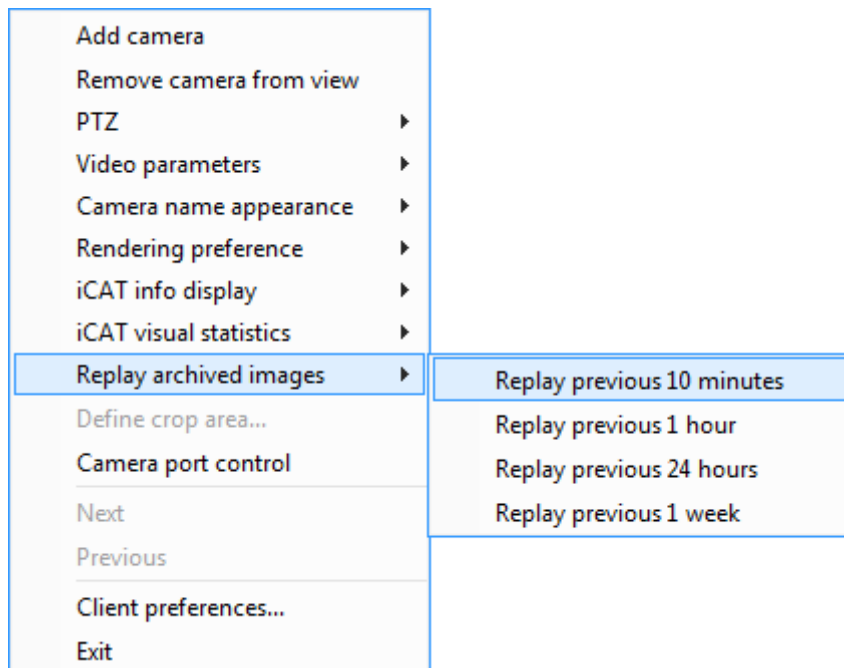

6.4.6 Defining a crop area

For views where you have the **Crop image to fit view port** setting selected, you can define what part of the cropped camera image you want to see by choosing **Define crop area...** from the menu.

6.5 Zooming in a view port and in archive recordings

Observer allows you to zoom view ports in the Online monitor and in the Archive player.

Basically, you have two ways to zoom a view port or a recording in the Archive player:

6.5.1 Zooming with the mouse wheel

1. Just move the mouse pointer over a view port and turn the mouse wheel. The view port will zoom accordingly.
2. You can move the zoomed area in a view port by dragging it with the mouse.
3. Use the mouse wheel again to zoom out.

6.5.2 Zooming by drawing a zoom rectangle

1. With the mouse draw a rectangle in a view port.
2. Click in this rectangle, which will cause the view port to zoom accordingly.
3. You can position the zoom by dragging the rectangle. You can also modify its size by turning the mouse wheel.
4. Click outside the rectangle to return to normal (not zoomed) view.
5. You can remove the zoom rectangle by clicking into it with the mouse and pressing the **Delete** or **Backspace** key. Alternatively, you can drag the rectangle outside of the view port to remove it.

You can also have multiple zooming rectangles per view port.

Showing a zoomed view in another view port (Online monitor only)

1. Draw a zoom rectangle with the mouse.
2. Click into another view port. Now the zoomed area is shown in the other view port.
3. You can position the zoom by dragging the rectangle.
4. You can remove the zoom by clicking the rectangle with the mouse and pressing the **Delete** or **Backspace** key. Alternatively, you can drag the rectangle outside of the view port to remove it. Removing a rectangle will also remove the zoomed view from the other view port.

Please note: When PTZ control is enabled, any mouse actions are taken for PTZ control. In order to control the view port zooming, hold down the **CTRL** key while using the mouse.

6.6 Manual recording control in the Online Monitor

In addition to programmed recordings, you can also manually start and stop continuous recordings directly in the Online monitor. When manual recording control is set up, a recording button is shown in camera view ports in the Online monitor.

6.6.1 Setting up manual recording control

To enable recording control, you must do 2 things:

- Enable the manual recording camera access right for the user
- Set up a continuous recording schedule for the camera. The continuous recording schedule that is active at the time when the user pushes the manual recording button defines the format of the recording. Therefore you can also have different manual recording formats for different times in the day or week.

Enable the manual recording camera access right

Here is how to set the camera access right for manual recording (see 5.3 *Setting camera access rights* on page 50 for a general description on how to set camera access rights):

1. Login as administrator user (or another user with the right to modify user data).
2. Choose **User admin** from the **System administration** menu. This opens the **User admin** dialog.
3. Select the user or group for which you want to enable manual recording control.
4. Click the **Next** button twice to get to the **Camera Access Rights** dialog.
5. Select the camera or camera group for which you want to enable manual recording control.
6. Choose **Modify selected user or group** from the menu.
7. Enable the right **Manual recording control from Online monitor** by choosing **Enabled** from the pop-up menu.
8. Push **Save** to save your changes.

Set up a continuous recording schedule

In order to use manual recording control for a camera you have to define a continuous recording schedule (please refer to 7.1.1 *Scheduling continuous recordings* on page 72 for a general description of setting up schedules for continuous recordings):

1. Choose **Camera admin** from the **System administration** menu. This opens the **Camera admin** dialog.
2. In the camera tree select the camera for which you want to set up the recording schedule.
3. At the bottom of the screen, click on the **Next** button twice. This takes you to the **Scheduling** dialog. If you are setting up a new camera, this dialog will be quite empty.
4. In the menu select **Modify selected camera or group**.
5. Click the **Add** button to add a schedule slot to the **Time Intervals** list.
6. Click the **Change** button and choose **Continuous recording**.
Now the **Scheduling** dialog shows the settings for configuring continuous recording.
7. Now you can define the days and times for the recordings. You can activate individual days or, with the **All** button, the whole week at once. Select hours and minutes from the popup matrix. If you want that recording can only be started manually then make sure that the **Enable interval** checkbox is disabled.

Note: When a user pushes the manual recording button in the Online monitor actually the **Enable interval** checkbox is toggled. This causes the recording to either start or stop.

8. Set all the recording options as described in *7.1.1 Scheduling continuous recordings* on page 72.
9. Click on **Save** to save your settings.

6.6.2 Manually controlling recordings in the Online monitor

When everything is set up as described above then for the enabled user and camera a manual recording button is shown in any view port displaying the camera.



You can switch recording on and off by pushing the manual recording button. The recording state is shown by the color (a strong red dot means recording is on, otherwise recording is off).

Please note: For times not covered by a continuous recording schedule no manual recording button is shown.

6.7 Working with round tours (the Smart guard function)

Observer allows you to make virtual round tours of views. You can define round tours that contain certain views. When a tour is started, Observer walks you through all the views by automatically showing up the views in the **Online monitor**. This is like a virtual patrol of a security guard (Smart guard function).

6.7.1 Defining a round tour

Steps to add a new round tour:

1. In the Online monitor choose **Round tours...** from the view **Control menu**. Now the **Round tours** dialog opens.
2. In the **Round tours** dialog push the button **Add new round tour**.
3. In the **Tour name** field enter the name of the round tour.
4. Now you can select a view from the **Views** list and push the **▶▶** button to include it in the tour. By pushing the **◀◀** button you can remove a view from the tour. You reorder views in the tour by pushing the **Up ▲** and **Down ▼** buttons.

Please note: You can have the same view several times at different locations in a round tour. You can select multiple views in the **Views** list at once by holding the **CTRL** key while selecting the views.

5. For each view you can set a **Shuffle duration** that determines, how long (in seconds) this view is shown before Observer automatically changes to the next view in the tour. By pushing **Set for all** you can set the same duration for all view in the round tour.
6. Push **Save** to save your changes and **OK** to leave the dialog.

Later on you can modify an existing round tour by opening the **Round tours** dialog and then choose an existing round tour from the **Round tours** list and push **Modify round tour**.

A tour can be deleted by opening the **Round tours** dialog and then choose an existing round tour from the **Round tours** list and push **Delete round tour**. Then you have to enter your password to confirm the delete.

6.7.2 Activating round tours

After you have defined a round tour, a new **Round tour** selector appears in the **Online monitor**. To activate the round tour, just choose its name from the **Round tour** selector. This activates the automatic walkthrough all of the views in the round tour (Smart Guard function). The name of the round tour now appears in green to show that it is active. You can stop the tour by choosing a view from the **View** selector (the **Round tour** selector will change its color to normal to show that no tour currently is active).

6.8 Copying views between users

If there are several users in a system it can be a lot of work to create views for each user individually. In order to help, Observer offers the possibility to copy a selected view or all views (including all view settings) of an administrator user to other users. It is important that the user who copies the views to other users must have user administration rights (more specifically: „User admin: Access to User administration“ and „User admin: Manipulate user data“).

Please follow these steps:

1. Login as the user from whom you want to copy the view(s) and go to the Online monitor.
2. Create the view(s) you want to copy. Please note that only saved settings are copied.
3. Open the view you want to copy, open the view's **Control menu** and choose **Copy current view to other users...**

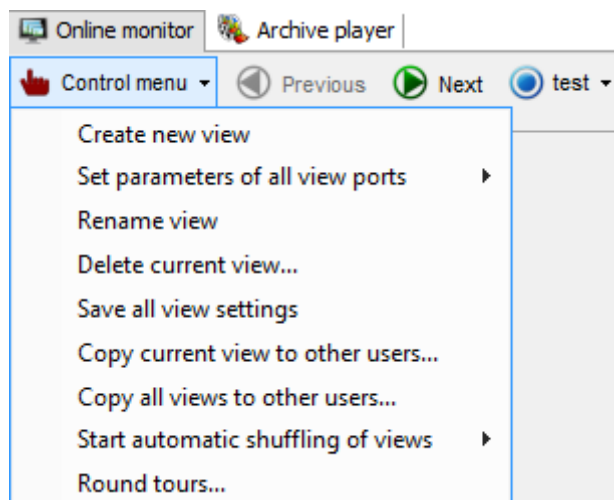

4. Now a user selection dialog opens:

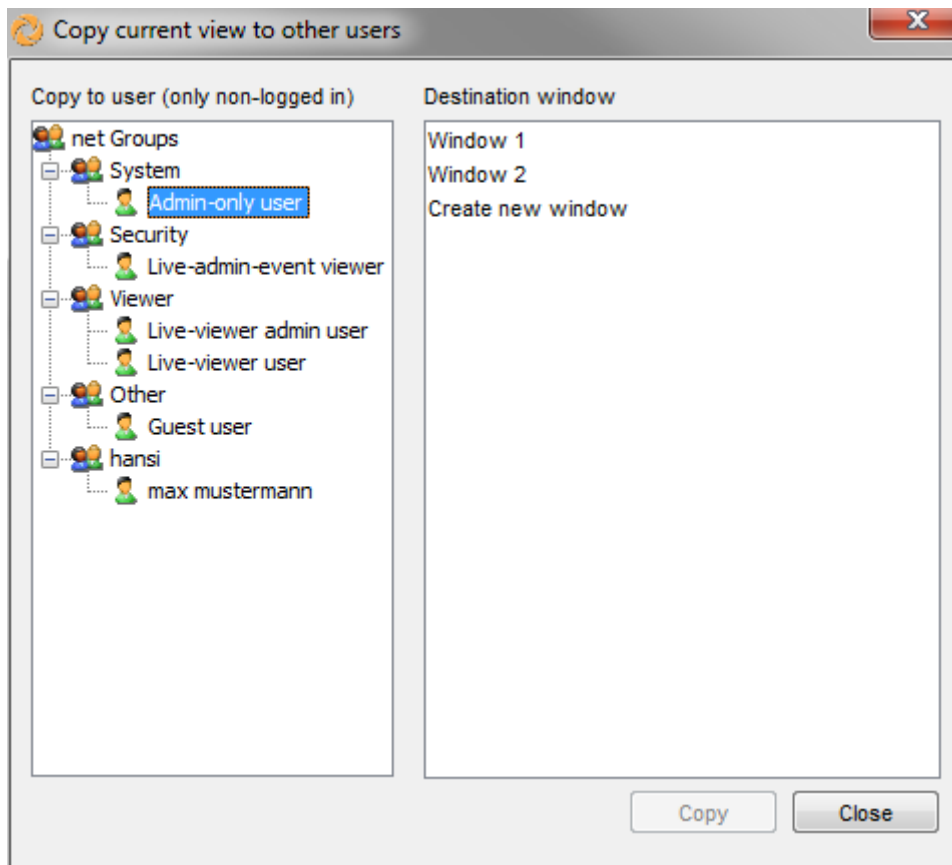

5. Select the user you want to copy the current view to, whereby views can only be copied to logged-out users and your own account. You can then choose one of the user's windows or select **Create new window** as a target for the current view. After you have finished the selection press the **Copy** button. Now the selected user receives a copy of the current view in the designated window.

Hint: Multiple users can be selected by holding down the CTRL key while clicking on user names. When selecting multiple users it is only possible to select **Create new window** as a target for the current view. So if you want to copy one or all views to specific windows (as opposed to a newly created window) of multiple users you have to copy them to each user individually.

6. The user who received the views has to log-in again in order for the changes to take effect.

You can also copy all views of the current user by choosing **Copy all views to other users...** from the view's **Control menu**.

Please note: If the users already have views with the same name as the copied views, then the existing views will be overwritten by the newly copied ones!

6.9 Working with MPEG cameras and audio (MPEG-4, H.264, H.265, and MxPEG)

Note: In the current version of Observer, MPEG and bidirectional audio is only supported by clients running on MS Windows. For further details please refer to *2.1 Introduction to Observer clients* on page 11.



Observer also supports MPEG cameras (MPEG-4, H.264, H.265, and MxPEG) with audio streaming (see also *4.2 Adding a new camera and basic configuration* on page 31).



If the camera allows MPEG streaming, you can select the MPEG streaming format from view port control menu. Once the MPEG streaming is activated, additional MPEG controls appear on the view port(s):



These controls allow you to see and modify Audio aspects:

Audio from the camera:  indicates that audio from the camera is on.  indicates that audio from the camera is off. A click on the icon turns it on or off.

Audio to the camera:  indicates that audio from your microphone to the camera is on.  indicates that audio from your microphone to the camera is off. A click on the icon turns it on or off.

If you have the **Default settings** in the **Camera Admin** set to **Audio from and to share single button** then you will see only one control icon: **Bidirectional Audio:**  indicates audio in both directions is on (loudspeaker and microphone is on).  indicates that audio in both directions is off (loudspeaker and microphone is off).

6.10 Dynamic View Control in Online Monitor

The use of dynamic views triggered by iCat and motion detection events was significantly simplified by the addition of a new configuration menu in Observer 4.5. Combined with the dynamic view control feature, archive access within the Online Monitor view ports now allows operators to quickly view event-triggered recordings without having to switch to the Archive. They are therefore able to keep an eye on live camera-streams while reviewing critical events.

Hint: Aside of controlling views with iCat and motion detection triggers, it is also possible to control them with the Matrix view function (see *23.4 Matrix View function of the Online Monitor (VIP control)* on page 195 for more details).

6.10.1 Controlling views via iCat events

Dynamic view configurations can be added to any of iCat triggers such as motion detection (MD), object tracking event trigger, sabotage detection, etc. Once the iCat definition is activated, the associated dynamic view is shown.

Here are the steps to control dynamic views via an iCat definition:

1. Choose **Video analysis (iCat)** from the **System administration** menu. This opens the **Video analysis (iCat)** dialog.

2. Select a camera and for the camera select an iCat definition.
3. Choose **Modify selected definition** from the menu.
4. Click the button next to the **Dynamic view action** field where you are presented with three options:
 - **No action** means that the Online Monitor's views are not changed. This is the default option for all iCat definitions.
 - **Show camera's live stream in large view** results in the live stream of the camera which triggered the iCat definition being shown in a large view. This option supports three different modes:
 - **Current camera:** The camera's live stream is shown on all connected clients.
 - **Camera-user pairs:** A list of camera-user pairs can be configured which specifies which cameras' large views are shown on the clients when the respective users are connected.
 - **Camera-IP Address pairs:** A list of camera-IP Address pairs can be configured which specifies which cameras' large views are shown on the clients connected from the respective IP Address.

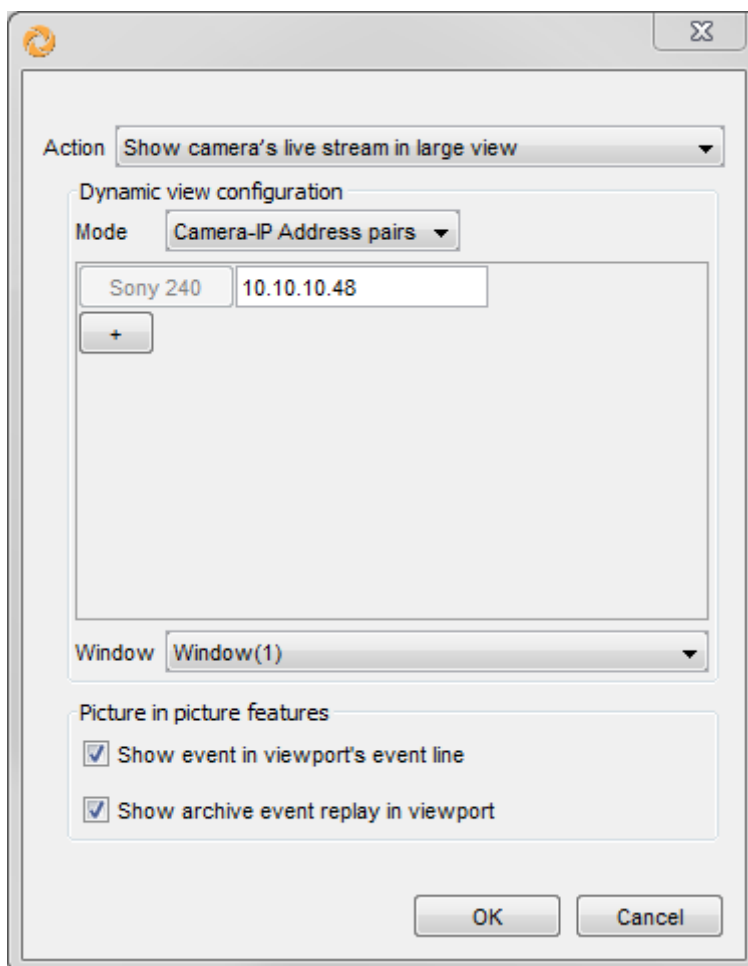

Additionally you can define in which Online Monitor **Window** the large view should be shown. For configurations which concern multiple users the largest common subset of available windows will be shown. With the **Current camera** mode only Window(1) is supported.

- **Show live streams in view** can be configured with **Additional cameras**, a selection of **Users**, **Windows**, and **Views** (please note that view ports used for dynamic view configurations should not be modified manually, e.g. by new adding cameras to them). Multiple cameras and users can be selected (and deselected) by keeping the CTRL button pressed. For single user configurations it is also possible to limit the feature to clients connected from a certain IP address. **Show live streams in view** offers three different modes:
 - **Replace oldest view port (first in, first out)**: The newest iCat events are always displayed in the "oldest" view ports (the view ports that stood there the longest without a camera change). Thus it is possible to create a view where always cameras with the newest events are displayed.
 - **Shift older view ports (from top left to bottom right)**: The newest iCat events are always displayed in the top left view port with all other camera views shifting towards the bottom right. Cameras in the lower right view port are removed from the view. Thus it is possible to create a view where cameras with the most recent events are always displayed at the top left position.
 - **Insert into empty view ports**: The newest iCat events are always displayed in empty view ports and each view port has a close button . When the user clicks the close button, the cameras are removed from the view, freeing the view port for another camera to be shown. Thus it is possible to create a view where cameras with the most recent events are always displayed and stay there until they are manually closed by the user.

Please note: When all view ports of the view are filled, no new cameras will be shown until a view port is freed.

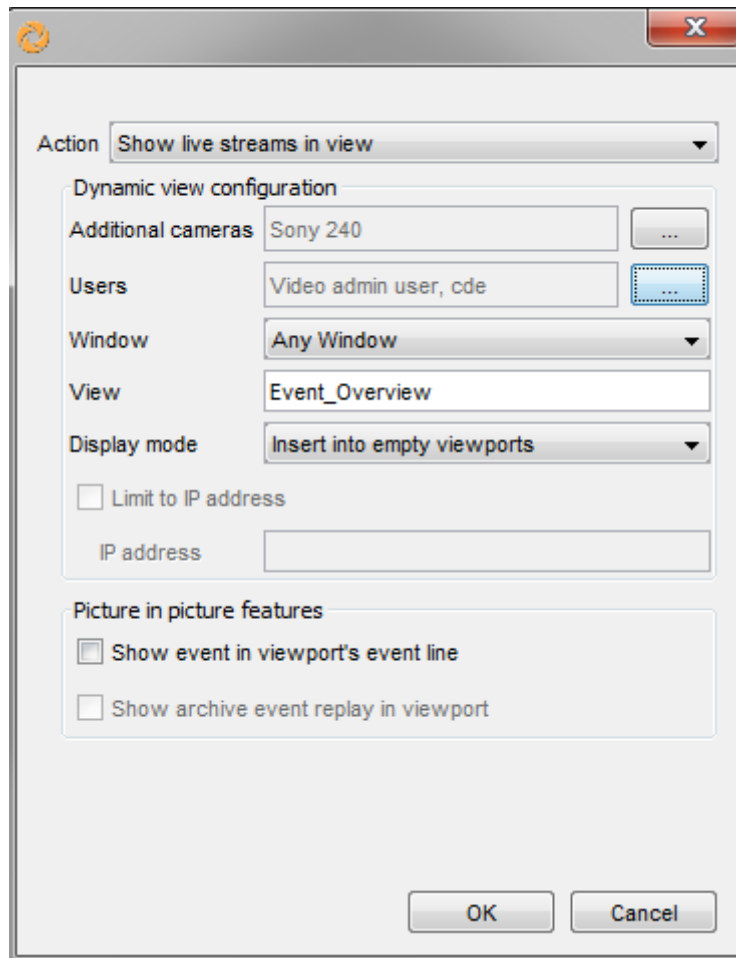

For the **Show camera's live stream in large view** and **Show live streams in view** options there are also **Picture in Picture features** which can be enabled:

- **Show event in view port's event line:** This option enables a list which keeps track of the events which occurred in the view port. To navigate between the events turn the mouse wheel up and down while hovering over the list at the bottom of the view port. By double clicking on an event in the list the **Event details** dialog is shown, whereby the **Acknowledge and next**, **Previous**, and **Next** buttons are disabled.

2013-12-16 16:58 Motion event test_md on camera Sony 240 (pop:1,,1,1,1;;). 1/2

Please note: The background color of the event line is the **Highlight color** which has been set for that iCat or motion detection definition. As of Netavis Observer 4.5 and similarly to the camera name label it is also possible to change the size (CTRL key + mouse wheel up or down) and contrast (CTRL + Shift keys + mouse wheel up or down) of the event list.

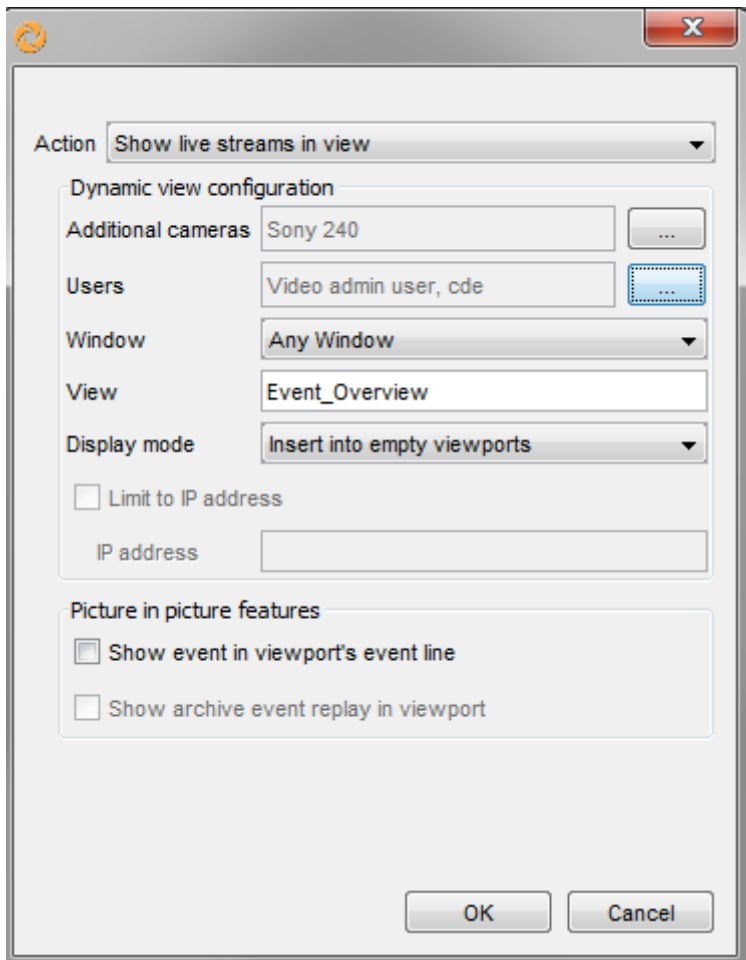

- Show archive event replay in view port:** This option enables Archive Access from within the Online Monitor view port which contains the camera which triggered the iCat definition. It can only be used if the **Show event in view port's event line** option is enabled.

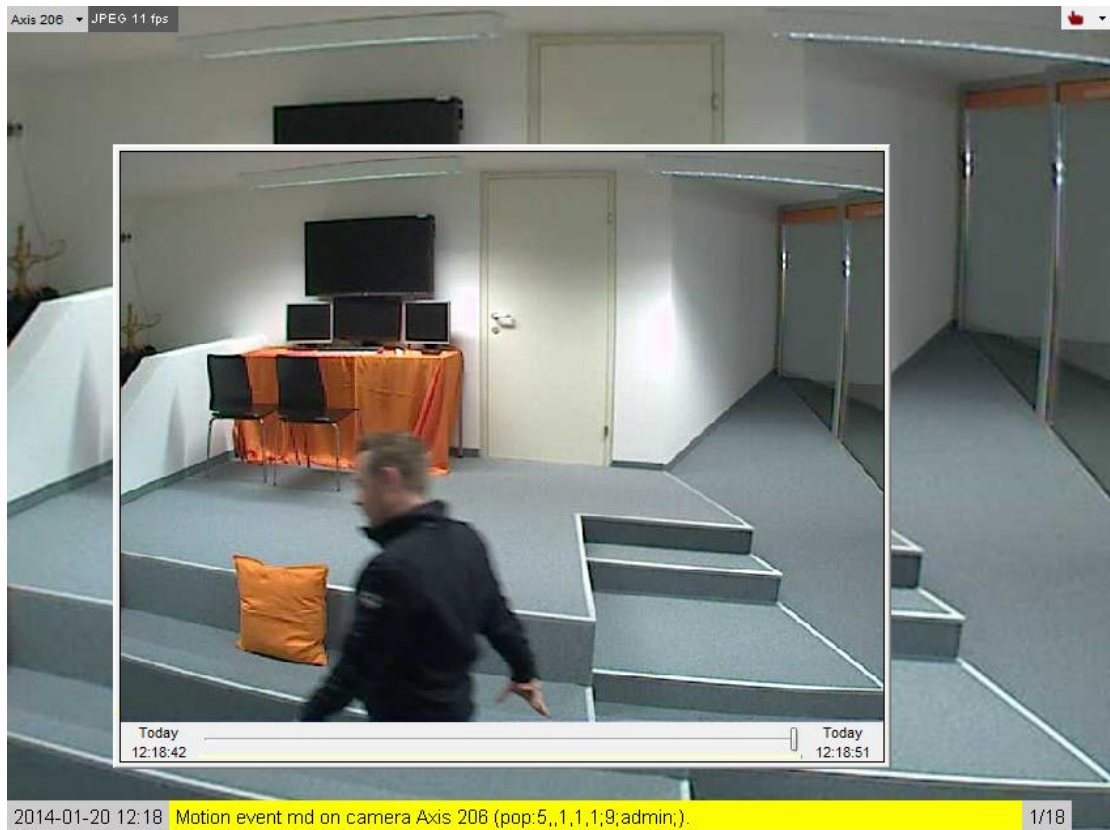

To watch the event you can either drag the timeslider to the corresponding position or click on the preview window to watch 10 second segments of the recording.

The Archive Access window can be moved by pressing the CTRL key and dragging the window with the mouse and it can be resized by pressing the CTRL key and turning the mouse wheel.

The event line and archive replay window are automatically removed when all the cameras in the corresponding view port are removed.

Please note: Until all the cameras are removed the event list and archive playback window configuration in the corresponding view port stay the same as configured in the definition of the iCat or motion detection event which first triggered a video stream to be shown in it.

- Alternatively it is also possible - but not generally recommended - to use the **Comment** field to add a dynamic view command to an iCat definition.

pop: <mode>,<view-name>,<window-ID>,<viewport-eventline>,<viewport-archive-replay>; <additional-camera-IDs>; <user-names>; <IP-addresses>

where:

<mode> is one of:

- 1:** shows the camera in a large view.
- 2:** shows the camera and optional **<additional-camera-IDs>** in the view named **<view-name>** (must be supplied). The cameras are placed in the "oldest" view ports (view ports that stood there the longest without a camera change). Thus you can create a view where always cameras with the newest events are displayed.

- **3**: shows the camera and optional **<additional-camera-IDs>** in the view named **<view-name>** (must be supplied). The cameras are placed row-wise starting at the top left view port. The cameras that were in these view port before are shifted to the right. Cameras at the lower right corner of the view therefore are removed from the view. Thus you can create a view where cameras with the most recent events are always displayed at the top left position.
- **4**: shows the camera and optional **<additional-camera-IDs>** in the view named **<view-name>** (must be supplied). The cameras are placed in empty view ports. They have a close button associated with them. When the user clicks the close button, the cameras are removed from the view, freeing the view port for another camera to be shown. Thus you can create a view where cameras with the most recent events are always displayed and stay there until they are removed by the user. Please note: When all view ports of the view are filled, no new cameras will be shown until a view port is freed.
- **5**: similar to mode 1 it shows the camera in a large view. The optional **<additional-camera-IDs>** are paired one-by-one with the **<user-names>**. This causes that these additional cameras are shown in large view at the clients where the supplied users are logged in.
- **6**: similar to mode 1 it shows the camera in a large view. The optional **<additional-camera-IDs>** are paired one-by-one with the in the **<IP-addresses>**. This causes that these additional cameras are shown in large view at the supplied clients workstations.

<window-ID> defines the window which will be used

<viewport-eventline> defines whether the events will be shown in the view port's event line whereby 0 disables this functionality and 1 enables it.

<viewport-archive-replay> defines whether the archive event replay is shown in the view port whereby 0 disables this functionality and 1 enables it. This functionality can only be used if the **<viewport-eventline>** option is enabled.

<additional-camera-IDs> is an optional comma-separated list of camera IDs which should be shown in addition to the camera that triggered the event.

<user-names> is an optional comma-separated list of user names to notify. If not defined, then all users are going to be notified.

<IP-addresses> is an optional comma-separated list of client workstation IP addresses to which the notification is sent. If not defined then all connected workstations are going to be notified.

Examples of commands to be used in any iCat comment field

pop:1;;;

shows a live view of the camera which triggered the event in all connected client sessions.

pop:2,my-view;3,4;;

shows live view of camera which triggered the event and the cameras with IDs 3 and 4 in the view named "my-view" in all connected client sessions.

pop:3,my_fifo;3,4;christoph;192.168.7.12

shows a live view of camera which triggered the event and the cameras with IDs 3 and 4 in the view named "my_fifo" where the IP address of the client workstation is 192.168.7.12 and user 'christoph' is logged in.

pop:4,my_dynamic;3,4;

shows live view of camera which triggered the event and the cameras with IDs 3 and 4 in the view named "my_dynamic" in all connected client sessions.

6. Press the **Save** button.

7 Working with archive recordings

This section shows you how to work with the Observer recording archive, particularly in the following areas:

- Programming archive recordings (timed or triggered by iCat (video analytics) events)
- Selection and playback of archive recordings

Please note: In order to work with archive recordings you need to have the appropriate user privileges and camera access rights (for further details see *5.2 Setting general user privileges* on page 46 and *5.3 Setting camera access rights* on page 50).

7.1 Programming archive recordings

Two types of programming are available in Observer:

- timed recording
- recording on iCat (video analysis) events like motion detection or people counting

To be able to program recordings, you need corresponding user privilege.

7.1.1 Scheduling continuous recordings

With Netavis Observer 5.1 the previously available **Camera admin** page "Scheduling" has been replaced by the newly designed camera properties page, an updated camera wizard (see *4.2 Adding a new camera and basic configuration* on page 31 for details), and Schedule Admin (see *21 Schedule Admin* on page 187 for details). Please see the referenced chapters and sections for how to configure and schedule continuous recordings.

7.1.2 Scheduling video analysis (iCat) operation and recording

For information on how to schedule video analysis (iCat) operation and recording please refer to section *15.3.16 Scheduling iCat video analytics and recordings* on page 164.

7.1.3 Event-triggered recordings

The option **Event-triggered recordings** can be used to create schedules which control when externally triggered events handled by Observer's Event Management System (EMS) are recorded.

7.1.4 Operation of the Observer dynamic storage management

In the **Scheduling** dialog you can specify the **Requested recording period** property that defines how long recordings are to be kept by Observer. Any recordings that are older than the requested recording period are automatically deleted as long as you do not manually protect them from deletion (see *7.2.8 Protection of recordings against automatic deletion* on page 79).

For cases like motion detection-based recording it can be very difficult if not impossible to estimate the required storage space and therefore space for all requested recordings could be too short. To

help with this hopefully rare case, Observer uses an intelligent storage management process. This process always tries to store all requested periods for all recorded cameras.

However, if there is not enough space available, the allocation process is doing two things:

- It generates a system event once a day and sends an email to the Observer administrator telling him that there is not enough space for all recordings.
- It automatically truncates the recordings of cameras to allow a proportionally even distribution of the available space among all cameras.

For some special cameras that have to record the requested storage period in any circumstances, Observer offers the **Priority over other cameras (if storage space is short)** flag. If this flag is set for a camera, Observer always tries to store the requested period for this camera and truncates other cameras that do not have this flag set a little more. If there is more than 1 camera that has the flag set, the storage management process tries to store all of those cameras.

Algorithm of the dynamic storage management process:

Fill-time-percentage (FTP) = $100 * \text{Actual-recording-time} / \text{Requested-recording-time}$.

Observer tries to keep the FTP of all cameras of each of the two priority classes the same (high-priority cameras and lower-priority cameras). First the algorithm tries to fully record the high-priority cameras and then use what is left for the lower-priority ones, whereby all of those will reach the same FTP.

However, the low priority cameras can never go below an FTP of 10%. If the low priority cameras reach a level of 10%, then the storage management process starts truncating the archives of the high priority cameras as well. Anyway, this should never happen in a normal case and is only possible if the storage space is totally insufficient for holding the programmed recordings.

Since the storage management process considers recording time and not recording space for distributing the available space, it happens that the relatively small recording space of a camera with a low recording frame rate is truncated in the same proportion like the relatively big recording space of a camera with a high recording frame rate.

Caution: Please be careful when you set the **Priority over other cameras** flag since, if storage space is short, Observer truncates the archives of all other cameras in favor of this camera. If available storage space is much too short relative to the requested storage periods of all cameras, this can lead to strongly truncated archives.

7.2 Playback of archive recordings

Observer features a multitude of powerful functions for working with archives.

7.2.1 Selecting the camera and the playback period

1. Go to the main window and choose the **Archive player** (if the Archive player is not available, then perhaps it is disabled in the client preferences; see 2.3 *Client multi-window and multi-screen operation* on page 17).

Either the **Camera tree** appears immediately or you have to push the **Select camera** button  :

2. Select the camera from the camera tree and push **Select** (you can also double click a camera or drag it to the calendar view). An overview for the selected camera on the current day is displayed:

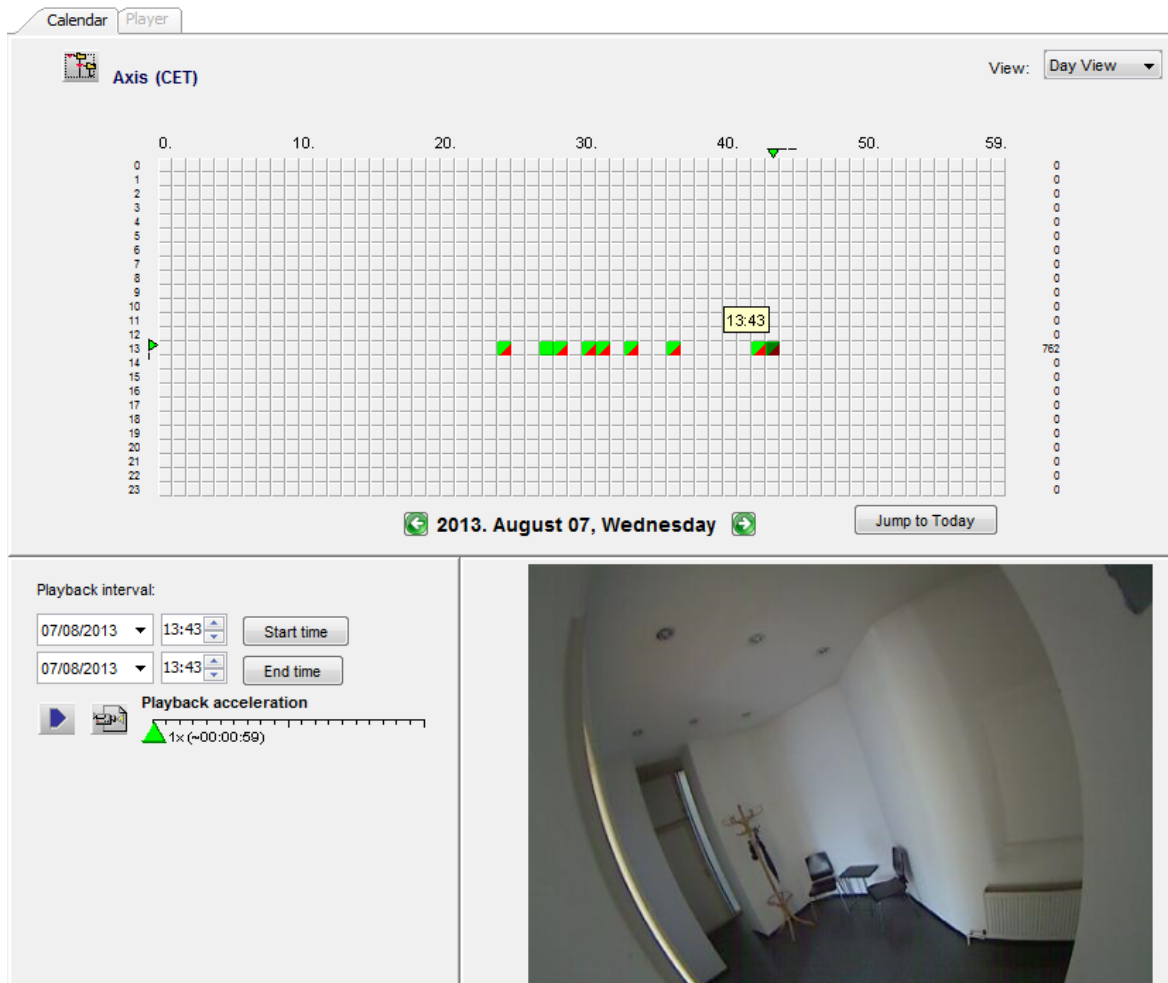

This one-day overview shows green blocks indicating minutes for which recordings have been archived. A red corner in a block indicates that an event was triggered and an event recording was started in that minute.

When you move the mouse pointer over a green block, then the first recorded frame of this minute is displayed in the lower right corner of the window.

You can also switch to a monthly or an annual overview via the **View** button and its popup menu.

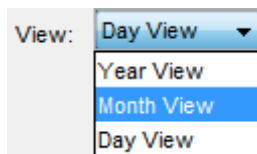

Here is an example of a month view for the camera:

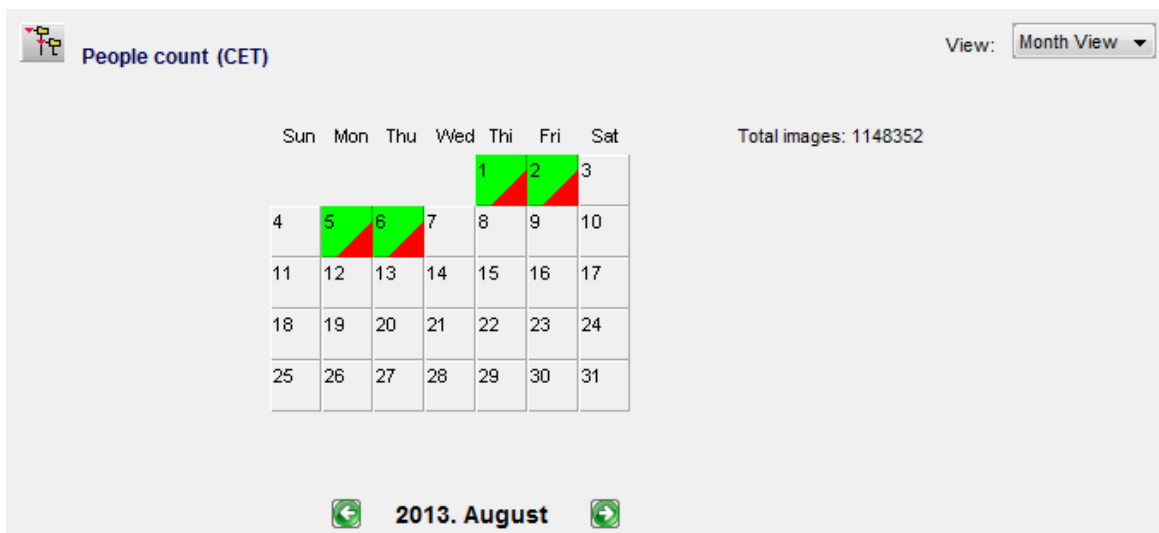

- With the mouse select the time span of the archive that you want to playback. To do this press the left mouse button at the start of the time range, then move the mouse pointer to the end of the time range and then release the mouse button. The color of the selected time range changes to dark green.

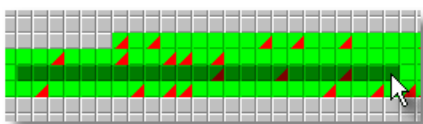

- Also select the playback acceleration by moving the **Playback acceleration** slider (default value is 1). At the slider you can see in parentheses how long the selected time will need for playback at the selected playback acceleration.
- Now click the **Playback** button . This brings you to the **Player** view and the images for the selected time span are loaded from the server and then will be replayed with the specified acceleration (you can cancel the loading process by pushing the **Cancel** button).

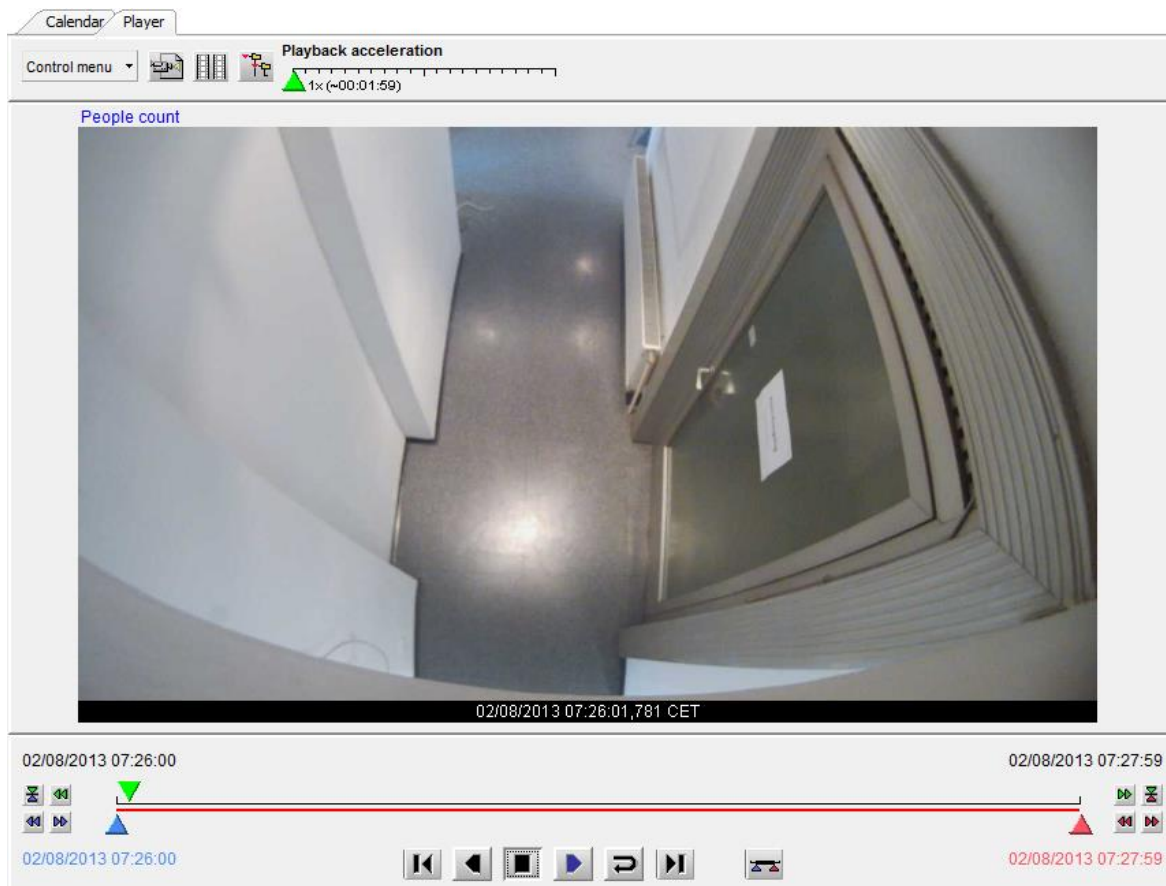

In the **Playback view** you have several possibilities:

- Automatic or manual fast forward and rewind of recordings
- Selection and playback of a time frame (time zooming)
- Synchronous playback of recordings of up to 4 cameras
- Export of individual images as well as the selected video sequence

7.2.2 Moving forward and back in the recording

Automatic playback: By clicking the **Playback** buttons  or  you can let the recording automatically play forward or backwards. (Due to the archive storage mechanism backwards playback might be a little jumpy with MPEG-4 and H.264 streams.) With the **Playback Speed** slider at the left of the window you can vary the playback speed. Press the **Stop** button  to end playback.

Manual playback: By clicking and moving the green Playback marker , you can control the playback of images manually.

You can select the size of the playback by clicking the **Original size** button at the lower left of the **Player** dialog. Here you have the possibility to choose from various sizes.

7.2.3 Zooming in a view port and in archive recordings

Observer allows you to zoom view ports in the Online monitor and in the Archive player.

Basically, you have two ways to zoom a view port or a recording in the Archive player:

Zooming with the mouse wheel

1. Just move the mouse pointer over a view port and turn the mouse wheel. The view port will zoom accordingly.
2. You can move the zoomed area in a view port by dragging it with the mouse.
3. Use the mouse wheel again to zoom out.

Zooming by drawing a zoom rectangle

1. With the mouse draw a rectangle in a view port.
2. Click in this rectangle, which will cause the view port to zoom accordingly.
3. You can position the zoom by dragging the rectangle. You can also modify its size by turning the mouse wheel.
4. Click outside the rectangle to return to normal (not zoomed) view.
5. You can remove the zoom rectangle by clicking into it with the mouse and pressing the **Delete** or **Backspace** key. Alternatively, you can drag the rectangle outside of the view port to remove it.

You can also have multiple zooming rectangles per view port.





Showing a zoomed view in another view port (Online monitor only)

1. Draw a zoom rectangle with the mouse.
2. Click into another view port. Now the zoomed area is shown in the other view port.
3. You can position the zoom by dragging the rectangle.
4. You can remove the zoom by clicking the rectangle with the mouse and pressing the **Delete** or **Backspace** key. Alternatively, you can drag the rectangle outside of the view port to remove it. Removing a rectangle will also remove the zoomed view from the other view port.

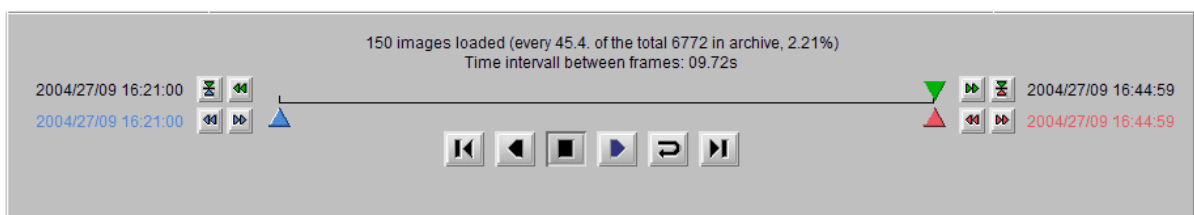
Please note: When PTZ control is enabled, any mouse actions are taken for PTZ control. In order to control the view port zooming, hold down the **CTRL** key while using the mouse.

7.2.4 Playback of a time frame (time zooming)



1. The red and blue markers   let you select a smaller time interval for detailed playback. Alternatively, you can click the **Set Blue Marker** button  or **Set Red Marker** button  to set the respective marker at the current position of the green Playback marker.
2. Click the **Zoom in** button  to load and replay the time interval between the blue and red markers.

7.2.5 Playback with audio

If the recording also includes audio (i.e. the recording has been done with MPEG-4 or H.264 and with Audio recording enabled), then you can decide whether you also want to replay audio. By default Audio is switched off, when you replay. To toggle audio on or off, select **Control menu - Enable speaker** in the Playback view.

7.2.6 Synchronous playback of up to four recordings

1. Select the playback time frame for the first camera as described above. Then change to the **Player** view.
2. Click the **Synchronous Playback** button , which opens the **Camera tree**, where you can select the second camera for synchronous playback.
3. Repeat camera selection until you have up to 4 cameras for synchronous playback.

The following illustration shows synchronous playback of two cameras:

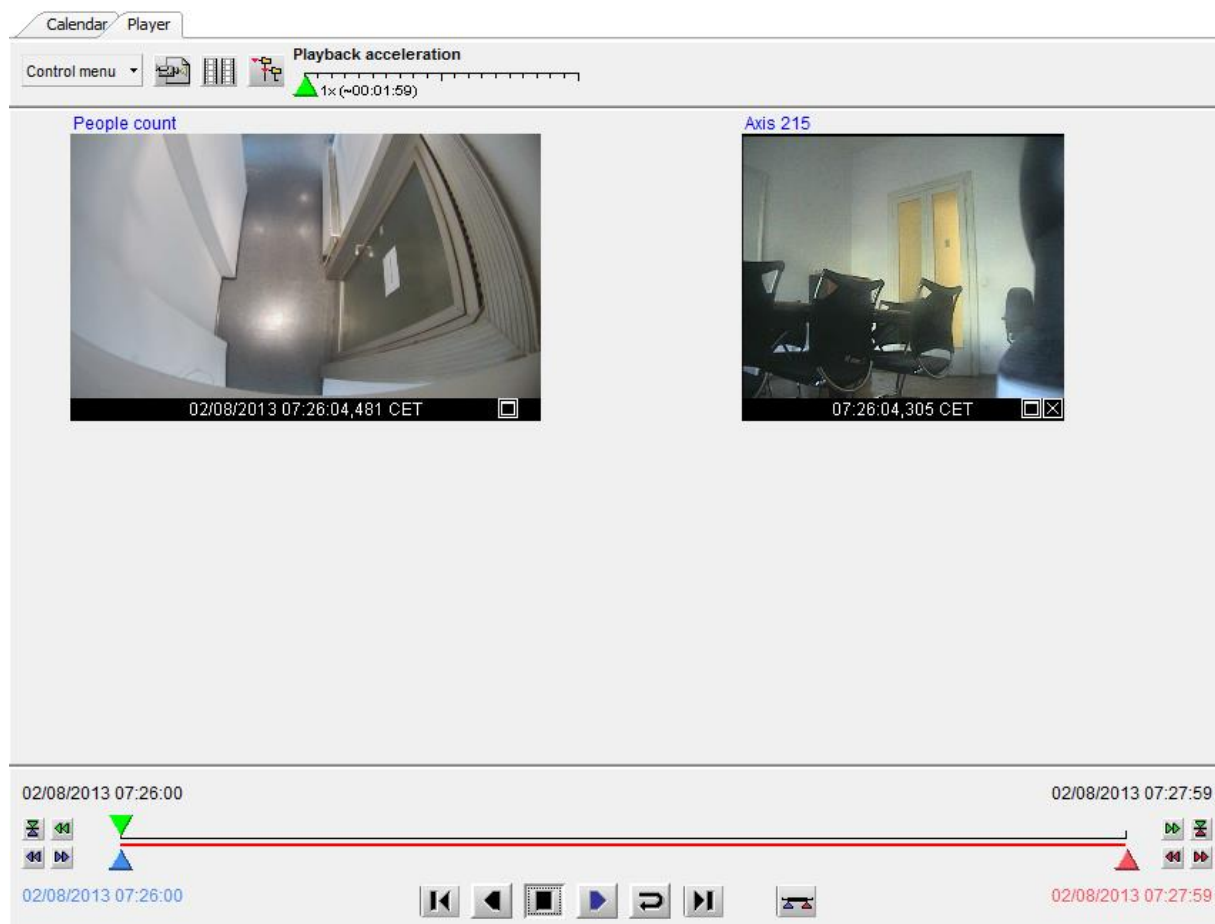

Note: Synchronous playback always loads one frame or GOP for each selected camera after each other.

7.2.7 Displaying video analysis (iCat) information for recordings

The **iCat** submenu in the **Control menu** offers various options for displaying iCat-related video analysis information also for recordings. Please refer to *15.4 Working with iCat* on page 164 for further information.

7.2.8 Protection of recordings against automatic deletion

Normally Observer automatically deletes recordings that are older than the **Requested recording period** in order to free space for new recordings. For cases where you want to keep certain scenes longer than the requested recording period you can protect arbitrary periods against automatic deletion. Here is how you can do that:

1. In the **Archive** go to the **Calendar** view and select a camera.
2. In the calendar select the period you want to protect against automatic deletion.
3. Press **Protect selected images against deletion**.
Now the color of the selected period in calendar turns to a different color which shows that the images are protected.

To unprotect a protected period you must select this period in the **Calendar** view and Press **Unprotect selected images**.

With the **Day limit of remove protected archive** option (see 11.2 *Setting Observer server parameters* on page 109) it is possible to limit the time that these manually protected recordings are stored. Afterwards they are deleted automatically.

Caution: Please be careful when using this feature. Unless you set the aforementioned **Day limit of remove protected archive** option the protected recording periods will never be deleted automatically by Observer. This means that the space will be locked as long as you keep them protected.

7.3 Exporting recordings (images and video sequences)

Observer allows you to export individual images and video sequences in various formats:

- JPEG: for single images
- AVI DivX: for video sequences
- SAFE: This is a proprietary format that stores the video together with the player in an executable format (.exe) that can be run on MS Windows platforms. The file can be password protected (up to 10 characters) and you can export synchronous video sequences of up to 16 cameras simultaneously.

The following sections describe how you can export from the recording archive. In 9.2.2 *Exporting event-related recordings* on page 96 you learn how to export recorded video sequences based on events.

7.3.1 Exporting a single JPEG image (the current frame)

1. In the **Archive**, select a camera for the export.
2. In the **Calendar** select the time for exporting the image.
3. In the **Player** move to the picture you want to export and click the **Export** button  to open the **Export** dialog.
4. Choose **Current image (JPEG)** from **Export format**.
5. Enter a file name for the image to be saved.
6. Mark the first checkbox if you want to overwrite a file of the same name that might exist.



7. When you click **OK** a file dialog will be opened asking where on your client computer you want to save the file. Select the location and confirm.
8. Now you can use the exported file.

7.3.2 Exporting a recording in AVI DivX format

1. In the **Archive player**, select a camera for the export.
2. In the **Calendar** select the time period for exporting.
3. In the **Player** view or in the **Calendar** view click the **Export** button  to open the **Export** dialog.
4. You have two **AVI** options for **Export format**:
 - **AVI (all images)**: This exports a video sequence with all the frames of the currently selected time frame (regardless of the **Playback acceleration** setting).
 - **AVI (Subsampled movie)**: This exports the time-lapse playback with the settings of the **Playback acceleration** slider. E.g. if you have selected a **Playback acceleration** of 3, your exported file will be roughly a third of the size of an **AVI (all images)** export. See also 7.2.1 *Selecting the camera and the playback period* on page 73.
5. Enter the file name of video to be exported.
6. Mark the first checkbox if you want to overwrite a file of the same name that might exist.
7. When you click **OK**, a file dialog will be opened asking where on your client computer you want to save the file. Once you select the location and confirm, a **File download progress dialog** will show the state of the export. You can cancel the export anytime by pushing **Cancel**.

Note: To play back exported video sequences with Microsoft Media Player, you need the DivX codec. You can download this for free from www.divx.com/divx.

7.3.3 Exporting a recording in SAFE format

1. In the **Archive**, select a camera for the export.
2. In the **Calendar** select the time period for exporting.
3. In the **Player** view or in the **Calendar** view click the **Export** button  to open the **Export** dialog.
4. Choose **SAFE (All images)** from **Export format**.
5. Enter the **Filename** for the video sequence to be exported. Check the **Overwrite old file** checkbox if you want to overwrite a file with the same name.
6. Optionally you can create a **Multi camera export** (synchronous video sequences) by clicking on the **Select camera** button . This opens the camera tree in which you can select multiple cameras by holding the **CTRL** key while clicking on the cameras.
7. Enter an **Export file label** which should describe the exported scenes.
8. Optionally you may enter an **Export file password** (which needs to be confirmed by entering it a second time in the text box below). This password is required when opening the exported file.

Caution: Do not forget this password because otherwise you cannot open the exported file.

9. When you click **OK**, a file dialog will be opened asking where on your client computer you want to save the file. Once you select the location and confirm, a **File download progress dialog** will show the state of the export. You can cancel the export anytime by clicking **Cancel**.

- The exported file is an executable for MS Windows 8/7/Vista/XP. Below you can find a screen of the running SAFE Player:

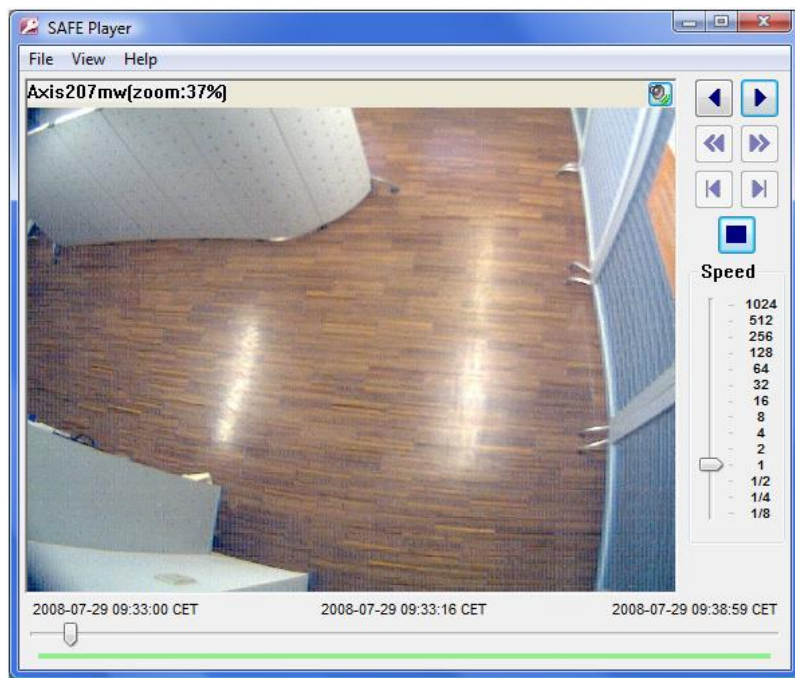

Zooming in exported SAFE video sequences

You can zoom into parts of the camera view by drawing a rectangle and then clicking in the rectangle. You can drag a zoomed view with the mouse. Alternatively you can show the zoomed view in a separate window by selecting **View > Separate zoom window**. You can also use the mouse wheel to zoom in and out. See also *7.2.3 Zooming in a view port and in archive recordings* on page 76.

Displaying iCat information

The **iCat info display** menu (accessible via a right mouse button click) offers various options for displaying iCat information. Please refer to *15.4 Working with iCat* on page 164 for further information.

Controlling playback

There are several ways to control the playback of the recording. Besides the **Play backward** and **Play forward** buttons it is possible to go the **Previous Frame / Next Frame** and **Jump to start / Jump to end** when the playback is paused. The **Speed** of the playback can be controlled with a slider and ranges from **1/8th** to **1024x**.

7.4 Motion detection in archive recordings

Observer supports server-based motion detection not only for live camera streams but also in the archived recordings. Here you find information about how to execute motion detection on recordings.

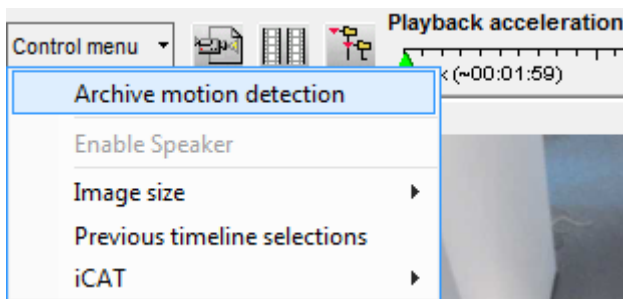

Please note: In this version, Observer supports archive motion detection only for MJPEG recordings and not for recordings of other streaming formats (like MPEG-4, MxPEG or H.264).

1. Go to the main window and choose the **Archive player** (if the Archive player is not available, then perhaps it is disabled in the client preferences; see 2.3 *Client multi-window and multi-screen operation* on page 17).
2. In the **Calendar** view of the Player select the camera and the timeframe for the motion detection.
3. Push on the **Playback** button . This will load the images of the timeframe and replay the recorded images.
4. In the Upper left corner of the **Player** view select **Archive motion detection** from the **Control menu**:

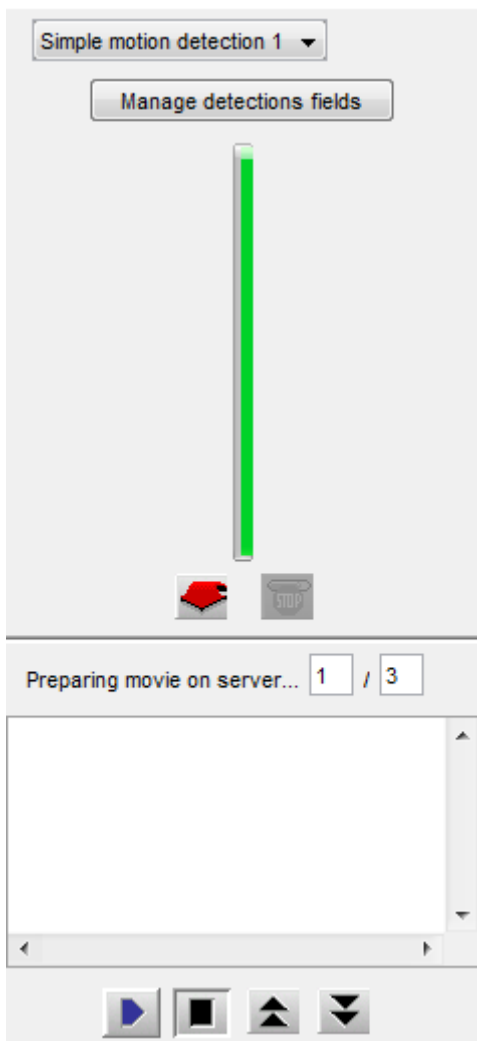

Now the motion detection pane is opened on the left side in the **Player** view:





- From the **Detection field** pop-up menu choose the motion detection field definition you want to use for this motion detection. If you do not yet have a detection field defined or want to change an existing definition, then you can push the **Manage detection fields** button to jump to the Detection fields view in Administration. Please refer to *8.1.2 Basic configuration of server-based motion detection* on page 86 for details on how to setup detection fields. Continuing here, we assume you have a correctly set up detection field definition.
- To start the server-based motion detection Push the **Start** button . You can see the progress of the motion detection at the progress bar. You can always stop a running motion detection by pushing the **Stop** button .

Caution: Since the motion detection actually runs on the Observer server and can potentially use up a lot of CPU resources, please be careful selecting the detection fields and also the time period. Especially if you have selected a long time period in the Calendar the motion detection can take a lot of time. As mentioned above, you can always stop a running archive motion detection.

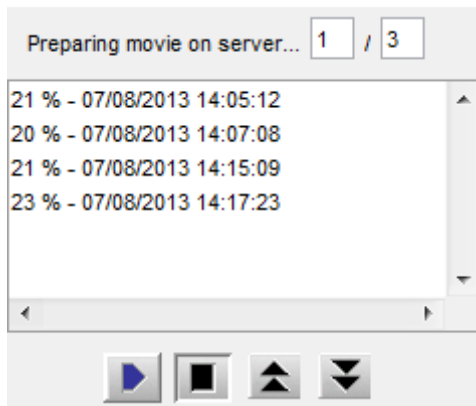
- While the motion detection is running, the detected motions are displayed in the hit list sorted by the time in which the motion occurred. In our example, we have 2 hits:



- You can replay the events by just selecting the event with the mouse. The playback time before and after the event can be defined by the **Pre/Post event (sec)** fields. You can change the values according to your needs. Please note that there must be archived pre- and post-event recordings available in order to be replayed.
- You can step through the events by pushing the **Previous**  and **Next**  buttons.

7.5 External archive management (NEA)

7.5.1 Introduction to external archives (NEA)

Starting with release 4.4 Observer offers external archives (NEA) for portable archive recordings. Simply connect an external storage device via eSATA to the server, then Observer can save video streams on the external storage in addition to the main archive storage. Thus it executes a second (mirrored or double) recording: recording on the external NEA device in addition to standard recording. The external archive can then be carried and connected to another Observer server for replay and analysis.

NEA also offers a swap function that allows the easy exchange of external storage devices during active recording without additional user interaction; therefore no particular operator expertise is needed for the exchange.

This chapter describes how you can manage removable storage devices (NEA devices) for external video recording.

Please note: The NEA recording on the external device is exactly the same as the standard recording on the main storage (at least as long as there is enough space on the device). The same recording algorithm is used for NEA as the main storage. This means when the NEA device is running out of space the oldest recordings will be overwritten. For a detailed description of how Observer manages recordings please refer to the *Operation of the dynamic storage management* section in the User Manual.

Apart from the NEA management functions in the client, NEA storage devices can also be configured and managed via the admin command line interface of Observer (see *Netavis Observer Server Installation and Administration*). Some more advanced functions like the setup of swap management for storage devices are accessible only in this interface.

7.5.2 Managing and accessing NEA storages

A user with the appropriate privileges can do the following with external NEA archives:

- Initializing of storage devices and starting of NEA recordings as well as stopping of NEA recordings and ejecting devices.
All of these functions are available in the **NEA storage management** dialog is accessible via the **System administration** menu of the main window.
The user privilege "Recordings: Manage external archive devices (NEA)" is needed for accessing the dialog. See 5.2 *Setting general user privileges* on page 46 on how to modify user privileges.
- Replay NEA external archives in the Archive player.
The user privilege "Recordings: View external archive recordings (NEA)" is needed.

For an explanation and setup of automatic swap management of NEA device please refer to the document *Netavis Observer Server Installation and Administration*.

Displaying the status of NEA storage devices

When a NEA storage device connected to the server you can view its status in the **NEA storage management** dialog accessible from the **System administration** menu of the main window. The dialog shows all connected NEA storage devices, their sizes and their **Status**:

- **Recording:** recording is currently running on the device
- **Archive:** a finished archive of the device can be accessed in the Archive player
- **Empty:** the storage device is empty (but initialized)
- **Unformatted:** the device must be initialized (formatted) first
- **Write error:** the device can be accessed in the Archive player

Initializing a device and starting NEA recording

When a new storage device is connected to the server via an eSATA connector, then the device is shown in the **NEA storage management** dialog accessible from the **System administration** menu of the main window.

You can start NEA recording on the device by pushing the **Initialize and start recording** button.

A new device will automatically be initialized (formatted) for NEA before the recording starts. This initialization is only executed once per device and it may take a while before it is finished. When initialization is done, recording will start automatically. Next time, recording will start immediately when you push the button.

Please note: All data on a storage device will be deleted, when it is initialized for NEA. Also note that the minimum size for a NEA archive is 5GB.

Stopping NEA recording and/or ejecting a device

In the **NEA storage management** dialog accessible from the **System administration** menu of the main window you can stop a NEA recording on the device by pushing the **Stop/eject** button.

When you push the button, all NEA recordings on the device will be stopped and the device will be unmounted/ejected. A dialog will open and ask you to unplug the device before pushing OK.

If you leave the device connected when you push OK, the archive of the device will be shown again in the camera tree of Archive player of users who have the appropriate privileges (see above). In such a case you have to execute the command **Stop/eject** again before unplugging the device.

7.5.3 Accessing NEA archives at another Observer server

Any user with the appropriate privileges can play back NEA archives easily at any Observer by just connecting the NEA storage device to the server.

The user privilege for accessing the NEA archives in the archive player is "Recordings: View external archive recordings (NEA)".

In the **Archive player** of the client the NEA archive appears automatically in the camera tree under the camera group **External Archive**:

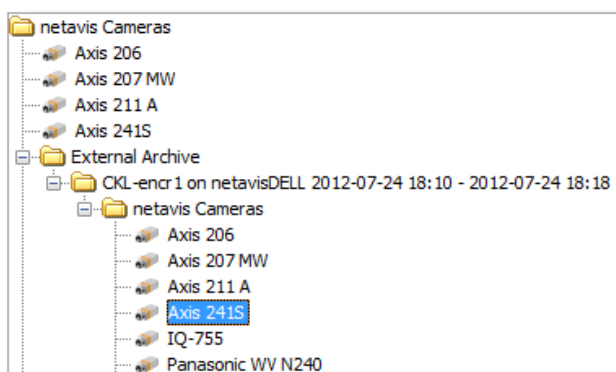

Please note: There are some limitations on external NEA archives, like Archive motion detection is not possible.

8 Working with motion detection

Please note: Since release R1.12 Observer offers powerful video analytics functions with iCat. This chapter describes the motion detection features that were present before R1.12 and that are now a part of the iCat toolbox. Motion detection is based on a detection of changed pixels between video frames while iCat offers intelligent object detection and tracking. For more details on iCat refer to *15 Video analytics with iCat* on page 142.

Observer offers two mechanisms for motion detection:

- **Observer's own server-based motion detection:** The images are analyzed by the Observer server. The advantage of this method is that it works with any camera, even old cameras. The disadvantage might be that if there are many cameras that transfer their images to the server for analysis, the bandwidth of the network could be burdened and also the server could be overloaded.
- **In-camera motion detection:** The images are analyzed in the camera and only when detection occurs, an event and image data are sent to the Observer server that then stores the event and the images in its archive. The advantage of this method is that the network and the server are not burdened. The disadvantage is that it works only with special cameras, that offer this feature and that the motion detection settings have to be programmed in the camera directly.

8.1 Observer's own server-based motion detection

The simple motion detection feature of Observer can recognize motion by detecting pixel changes between video frames. Such a detection can then trigger the following predefined actions:

- Entry of events in an Event list (optionally accompanied by an acoustic signal).
- Changes in recording behavior (e.g. higher recording rate) if that has been programmed (see *7 Working with archive recordings* on page 72).

Here you find the steps how to configure the parameters for simple motion detection.

8.1.1 Preparation

Before you begin to configure a motion detection definition, be sure that you have the necessary authorization to make settings. If you are not sure, please ask your Observer administrator.

Please note: Motion detection for PTZ cameras is problematic since normal movement of the camera will trigger a motion detection event.

8.1.2 Basic configuration of server-based motion detection

1. Choose **Video analysis (iCat)** from the **System administration** menu. This opens the **Video analysis (iCat)** dialog.

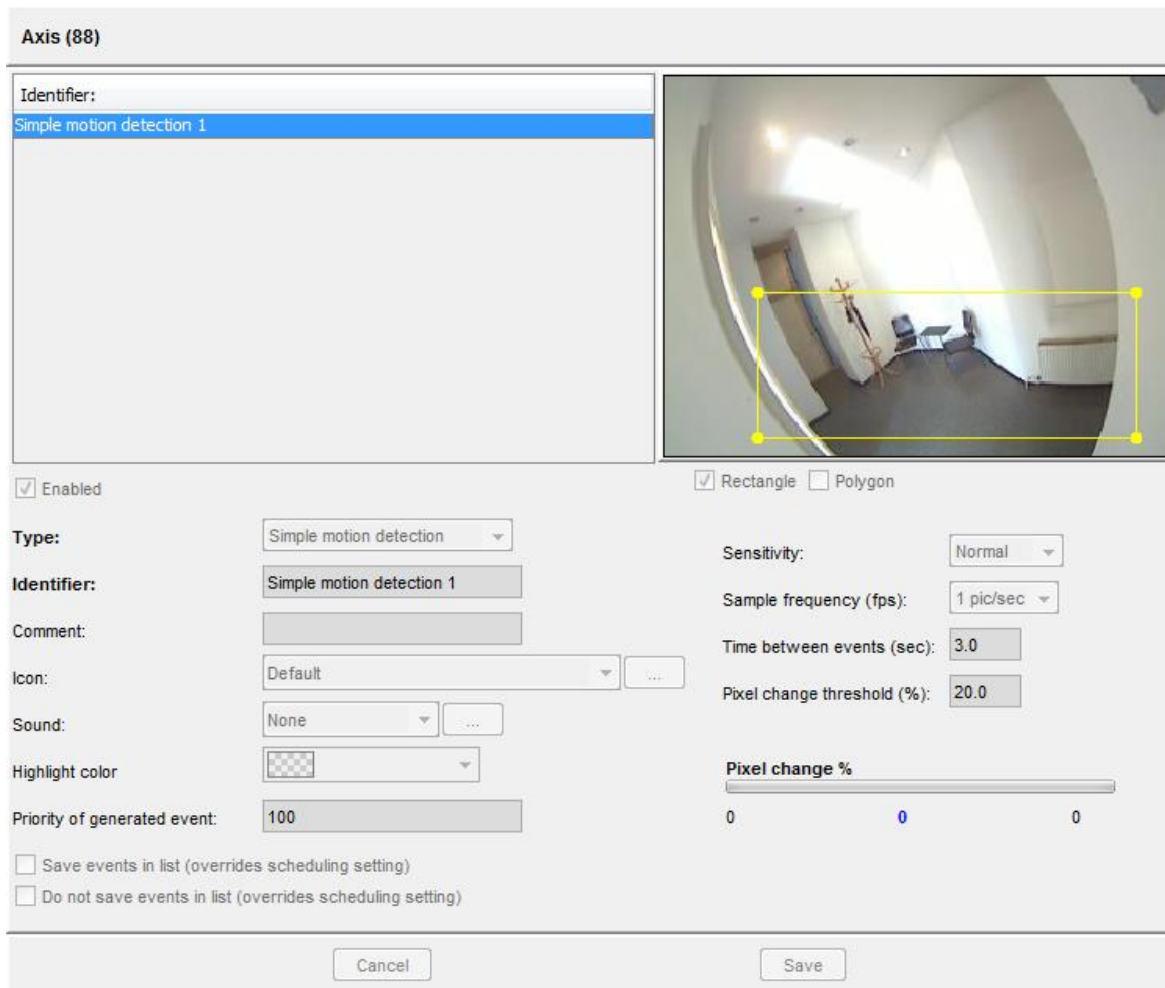

2. In the camera tree at the left, select the camera for which you want to create a motion detection definition.
3. In the menu choose **Add new definition**.
4. From the **Type** menu chose **Motion detection**.
5. Select whether you want to create a **Rectangle** or a **Polygon**.
6. Use the mouse to draw a detection field in the preview area.
7. Mark the **Enabled** checkbox, otherwise the detection field is inactive and no detection can occur. Actually, a detection field must also be assigned to an active motion detection schedule (see below).
8. Assign a name for the field in the **Identifier** text box, e.g. "Movement".
9. Optionally, you can enter a **Comment** which is shown in the event details.

Hint: You can also use the **Comment** field to configure certain views to be shown to one or multiple users when a motion is detected. See *6.10 Dynamic View Control in Online Monitor* on page 64 for more information.

10. Usually the **Sensitivity** should be left at **Normal**. It defines how sensitive (or tolerant) the detection algorithm is when detecting the change of pixels. Modify the setting only when you want the algorithm to be more or less sensitive.
11. In the **Sample frequency (fps)** field you can specify how often the image is to be checked for changes.

12. In the **Time between events (sec)** field you can enter the minimum time that must elapse before a following event is triggered. This helps to filter out repetitive events. Minimum time (sec) = 15 means that, after one motion detection event has been triggered, at least 15 seconds must pass before another event for the same Motion Detection is generated.

Note: In Netavis Observer 5.1 the default time between events value was increased to 15 seconds (the previous default value had been 3 seconds).

13. In the **Pixel change threshold (%)** field you can define how many pixels in % must change so that a detection event is triggered. Pixel change (%) = 20 means that 20% of the pixels relative to the previous frame (detection cycle) must change for a detection to be triggered.
14. Optionally you can define a specific event icon and sound for this definition: Click on the **Icon** button to assign a symbol. This icon is displayed in the **Event list** to notify an operator when an event related to this definition occurs.

Click on the **Sound** button to assign a specific sound to the definition. This sound is played when a user notification event related to the definition occurs.

15. After you have entered all parameters for your definition, save it by clicking on the **Save** button.
16. If you have not yet scheduled a detection-based recording for this camera, you will be prompted for whether you want to edit the scheduling now.

Click on the **Yes** button if you want to configure the scheduling now. Please refer to section *8.1.3 Scheduling motion detection* on page 88.

Click **No** if you want to do that later.

Please note:

If you add a new iCat definition, it will automatically be assigned to all iCat schedules of the camera. If you do not want that, you have to remove the assignment manually.

If a definition is not assigned to an active schedule then it will not be activated (no archive recordings will be made and no events will be generated) although it has the **Active** option set.

8.1.3 Scheduling motion detection

The scheduling for motion detection is the same as for other iCat definitions. Please refer to *15.3.16 Scheduling iCat video analytics and recordings* on page 164.

8.1.4 Controlling PTZ cameras with motion detection events

It is possible to assign a sequence of PTZ positioning actions to each motion detection (MD) field definition. Once the MD field gets active, the associated PTZ action is executed. PTZ actions can be assigned to an MD field by appending the following sequence to the MD **Identifier**:

ptz:<CID>:<PresetName>:<WaitTime>:<PresetName>:<WaitTime>...

where:

<CID> is the ID of a PTZ camera (the ID is shown in **Camera admin > Properties** dialog next to the camera name). If **<CID>** is 0, then the MD field's camera is controlled (MD and PTZ camera are the same).

<PresetName> is the name of a preset position (as entered in the PTZ definitions).

<WaitTime> is the pause time in seconds starting from the time when the camera receives the positioning event.

There can be any number of "**<PresetName>:<WaitTime>**" pairs added.

Further MD-triggered PTZ actions are blocked as long as a sequence is running. However, control of PTZ camera can be taken manually, then the automatic MD-triggered PTZ control is suspended until the manual PTZ control is released.

For information on how to setup PTZ preset positions refer to *10 Working with PTZ cameras* on page 100.

Example of an motion detection Identifier:

Door ptz:4:Door:10:HomePos:3

will on an MD event with the **Identifier** "Door" move the PTZ camera with ID 4 to the preset position "Door", wait 10 seconds and move the camera to the preset "HomePos" and wait another 3 seconds. The overall positioning time therefore is app. 13 seconds. From then on the PTZ camera is open to receive further MD-triggered PTZ positioning commands.

8.2 Motion detection in archive recordings

Observer supports server-based motion detection not only in live streams but also in archived recordings. Please refer to *7.4 Motion detection in archive recordings* on page 81.

8.3 In-camera motion detection

Several IP cameras and video servers support in-camera motion detection and upload (push) of event-triggered images via FTP or HTTP to a video management system like Observer. Observer implements a general mechanism to handle this feature.

This section describes how Observer supports in-camera motion detection and also how to configure it in Observer.

In order for in-camera motion via FTP to work the FTP service included with any Observer system has to be running (please refer to the NETAVIS Observer Server Installation and Administration guide for further information).

Note: Since the camera carries out the detection, the actual configuration and programming must be done directly in the camera via the setup interface (e.g. parameters like detection settings, image quality, speed, etc.). This can usually be done by connecting with a web browser to the camera (by entering its IP address). Please refer to the latest *Netavis Observer Supported Video Sources* and the camera's user manual for further details.

8.3.1 How Observer supports in-camera motion detection

In the camera you define the various settings for the motion detection algorithm and for the transmission of event images to the Observer server, which is done via FTP or HTTP ("push upload" by the camera). Most cameras also support the transmission of pre- and post-event images. The configuration of for these pre- and post-event images must also be done in the camera.

Observer is capable of doing these things in connection with in-camera motion detection:

- **Receive in-camera motion detection events** from the camera and store these events in the standard Observer Event database (these events can also be displayed in the Event list).
- **Receive pre- and/or post-event images** from the camera (pushed by the camera) and record these images in the standard Observer camera archive.
- Optionally, with receiving an in-camera detection event, **start a server-based post-event recording** of images and merging this recording with the in-camera event images pushed by the camera. This server-based recording can have a much higher frame rate than the pictures pushed by the camera. This allows a much better documentation of in-camera events.

Note: In-camera motion detection cannot be used on a camera in parallel with other types of recordings!

8.3.2 Setting up in-camera motion detection

To configure Observer for in-camera motion detection follow these steps:

1. Choose **Camera admin** from the **System administration** menu. This opens the **Camera admin** dialog.

Assuming that you have already defined the basic properties of the camera in Observer, select the camera in the camera tree.

2. On the **Properties** dialog press the **Next** button at the bottom of the dialog until you reach the **Defaults settings** dialog. Here you focus on the **In-camera motion detection** settings:

The screenshot shows a dialog box titled "In-camera motion detection and iCAT settings". It contains the following controls:

- "Receive event images via FTP" with an unchecked checkbox.
- "Receive event images via HTTP" with an unchecked checkbox.
- "Post recording length (sec):" with a text input field containing the value "0".
- "Frame rate:" with a dropdown menu currently set to "1 pic/sec".

3. In the menu choose **Modify selected camera or group**.
4. Mark either **Receive event images via FTP or ...via HTTP** depending on what your camera supports. This tells Observer to receive in-camera events and images from the camera. If you already have a defined an active server motion detection schedule for the camera, you will get a dialog that tells you that having both, server and in-camera motion detection at the same time is not possible. To continue you have to first disable the server-based motion detection schedules in the **Scheduling** dialog and then you can continue here.
5. Optionally you can set the **Post recording length (sec)** that defines whether and for how long the Observer server should record camera images in addition to receiving and storing the event pictures pushed by the camera. As mentioned above, you could want to do that to record the post-event images with a high frame rate. In such a case, set the **Frame rate** according to your needs.
6. Now you also have to tell Observer, for how long it should keep the recorded event-images (both, the ones pushed by the camera and the ones, additionally recorded by the server). Press the **Previous** button at the bottom of the dialog until you reach the **Scheduling** dialog.

7. Below the **Time intervals** list push the **Add** button and then choose **Camera MD (FTP/HTTP)** from the newly created **Change** pop-up menu.
8. In the field **Requested recording period (days/hours)** enter the values that fit your needs. Optionally you can also mark the **Priority over other cameras (if storage space is short)** checkbox. For further details about these recording parameters please refer to sections 7.1.1 *Scheduling continuous recordings* on page 72 and 7.1.4 *Operation of the Observer dynamic storage management* on page 72.
9. Push the **Save** button to store your changes.
10. Now you have to configure your camera for pushing the in-camera events and images to the Observer server. Since the steps for doing that are very camera-specific, you must consult the document *Netavis Observer Supported Video Sources*. To program the camera's detection algorithm please consult its user manual.

Note: After setting up the camera, do not forget to check and set the date and time of the camera to reflect your current time.

9 Handling events

Observer can record and display events of various types. These can be camera-related events like video analytics events, archive access by a user, or camera failures, but also system-related events like user logon and logoff.

Events are displayed in Event lists of the client and are stored in the central event database of the server where they can also be queried. They have several properties that depend on the type of the event.

Event priorities

All events also have an event priority that defines the relative importance of events. The default event priority is 100. Informational events have a lower priority of 50, system and camera malfunction events have a higher priority of 300. For events generated by video analytics triggers, you can specify individual event priorities. Event lists can also be sorted according to priority.

User privileges for accessing and handling events

In the **User admin** under the **System administration** menu you can define for each user some basic event handling privileges. For example whether user you can access events at all or what kinds of system events are displayed at the users event list (see 5.2 *Setting general user privileges* on page 46).

The number of events stored in the database can be defined in the server parameters (see 11.2 *Setting Observer server parameters* on page 109).

9.1 Event list and event details

The most recent events are displayed in the **Event list**:

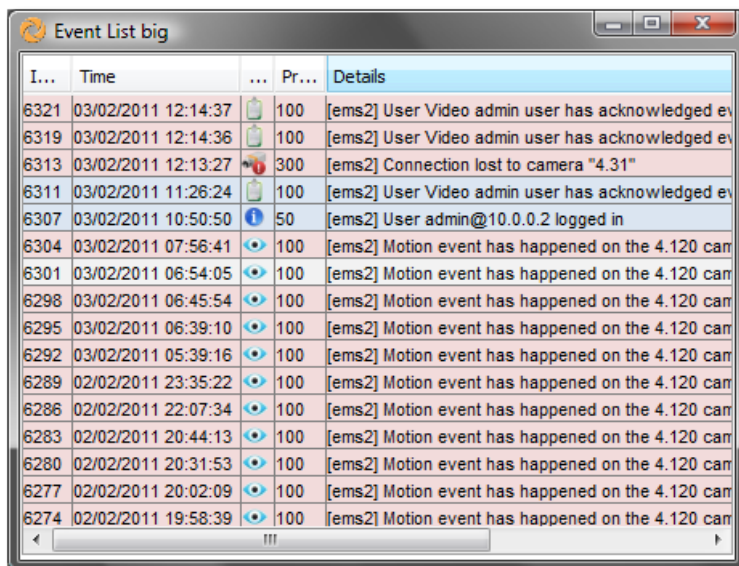

I...	Time	...	Pr...	Details
6321	03/02/2011 12:14:37		100	[ems2] User Video admin user has acknowledged ev
6319	03/02/2011 12:14:36		100	[ems2] User Video admin user has acknowledged ev
6313	03/02/2011 12:13:27		300	[ems2] Connection lost to camera "4.31"
6311	03/02/2011 11:26:24		100	[ems2] User Video admin user has acknowledged ev
6307	03/02/2011 10:50:50		50	[ems2] User admin@10.0.0.2 logged in
6304	03/02/2011 07:56:41		100	[ems2] Motion event has happened on the 4.120 carr
6301	03/02/2011 06:54:05		100	[ems2] Motion event has happened on the 4.120 carr
6298	03/02/2011 06:45:54		100	[ems2] Motion event has happened on the 4.120 carr
6295	03/02/2011 06:39:10		100	[ems2] Motion event has happened on the 4.120 carr
6292	03/02/2011 05:39:16		100	[ems2] Motion event has happened on the 4.120 carr
6289	02/02/2011 23:35:22		100	[ems2] Motion event has happened on the 4.120 carr
6286	02/02/2011 22:07:34		100	[ems2] Motion event has happened on the 4.120 carr
6283	02/02/2011 20:44:13		100	[ems2] Motion event has happened on the 4.120 carr
6280	02/02/2011 20:31:53		100	[ems2] Motion event has happened on the 4.120 carr
6277	02/02/2011 20:02:09		100	[ems2] Motion event has happened on the 4.120 carr
6274	02/02/2011 19:58:39		100	[ems2] Motion event has happened on the 4.120 carr

Each client can have multiple event lists, for example, one that is sorted chronologically and another one that is sorted according to event priorities. In the **Client preferences** you can configure for each window's event list what columns are to be displayed, whether acknowledged events should stay in

the list or should disappear automatically and other options (see 2.4 *Client preferences* on page 19 for more details).

The position of the event lists inside client windows and further layout options can be defined as described in 2.3 *Client multi-window and multi-screen operation* on page 17.

You can sort the event list according to column values by just clicking on the column title. Little arrows after the title indicate the sorting order (ascending or descending). Clicking a column title again will change the sorting order. For example, you can sort the list according to event priority by clicking on the **Priority** column heading.

In an event list columns can be rearranged by clicking on a column title and dragging it with the mouse to the new location.

Unseen events have a light red background color. As soon as an event has been opened in the **Event details** dialog its background color changes to light grey. When an event is acknowledged, it usually disappears from the event list. However, in the client preferences you can define whether acknowledged events should be displayed in the event list. If so, they appear with a white background color.

9.1.1 Event details

Double clicking on an event in the event list opens the **Event details** dialog.

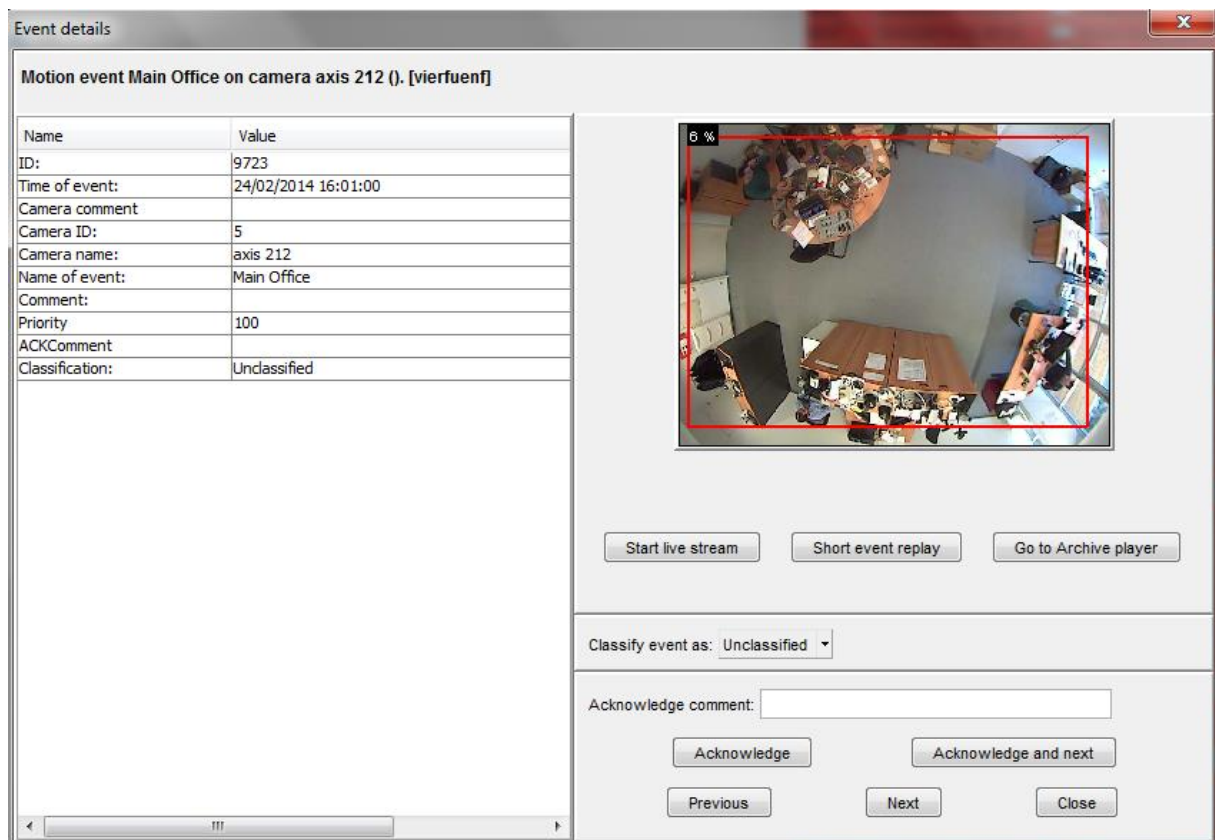

The first line contains the event text. Further details of the event are listed at the left side of the dialog. The exact contents of the event details depends on the event type, but you will at least find the exact time when the event occurred and if it is camera-related then also the camera ID and name are shown.

When you move the mouse over the camera preview area you will also see the video analytics object markers and annotations related to the event trigger (as seen in the screenshot above).

The following options are available for users:

- **Start live stream:** Starts live monitoring of the camera that triggered the event.
- **Short event replay:** Starts a playback of the event recording that triggered the event (a replay is only available if the camera has been configured to record the event).
- **Go to Archive player:** Opens the Archive player and starts a playback of the event recording.
- **Classify event as:** The event can be classified as **Unclassified**, **Irrelevant**, **Valid (true)**, and **Invalid (false)**.
- **Acknowledge comment:** This field can be used to add an optional comment related to the acknowledgement of the event.
- **Acknowledge:** Acknowledges the event and close the dialog.
- **Acknowledge and next:** Acknowledges the event and loads the next event.
- **Previous:** Loads the previous event.
- **Next:** Loads the next event.
- **Close:** Closes the dialog.

9.2 Searching for and exporting events

1. When you choose **Event search...** from the **Events** menu the **Event search** dialog appears:

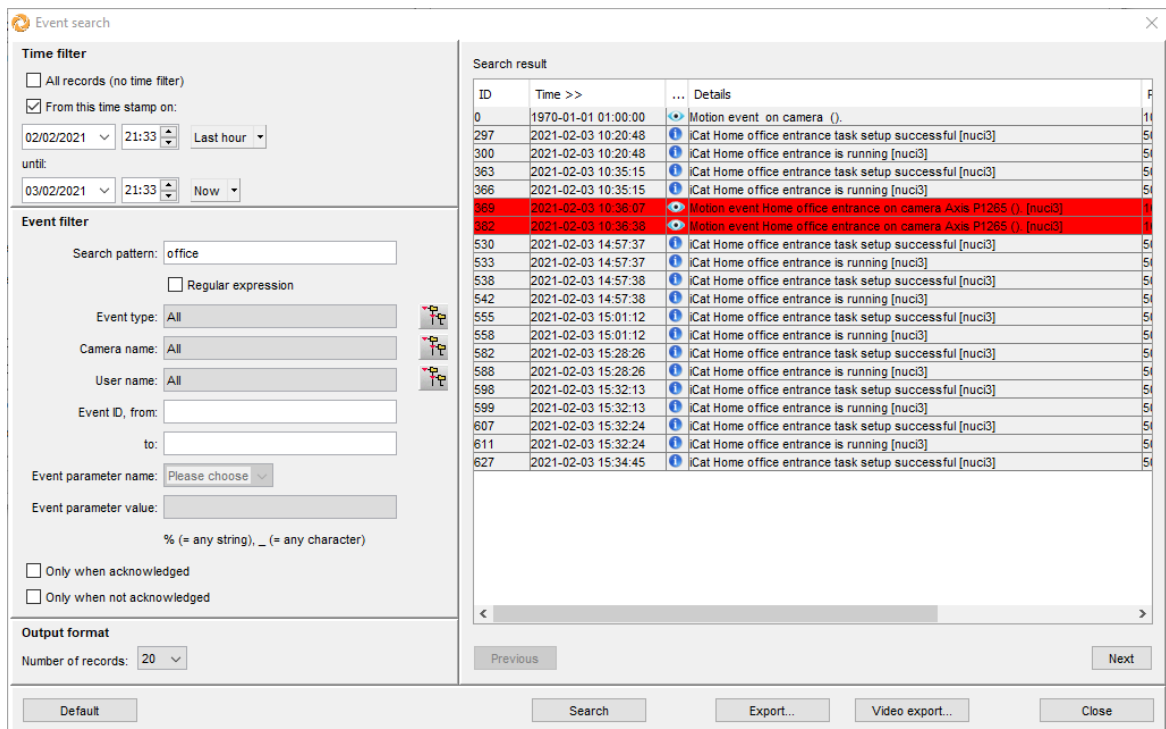

2. Netavis Observer 5.1 introduced full-text search which enables quick searches by simply entering the desired text in the **Search pattern** field. Additionally, it is also possible to use **Regular expressions** by enabling the corresponding option.
3. Select the **Time filter** according to your needs whereby the options are either **All records (no time filter)** or manually choosing a time interval.

- You can further constrain the search by using **Event filters** for **Event type**, **Camera name**, **User name**, or **Event ID (from- to)**, and event-specific **parameters** and their **values** (e.g. the event's classification). For some filters an appropriate dialog will open, e.g. the Event selection dialog:

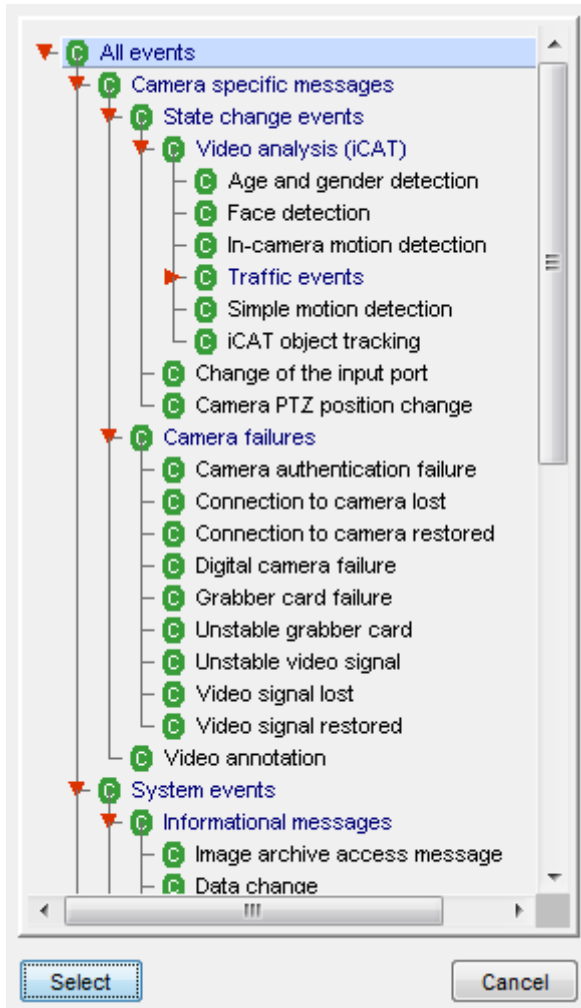

In each of the dialogs it is possible to make multiple selections. For example to search for the event types **In-camera motion detection**, **Simple motion detection**, and **iCat object tracking**, hold down the **CTRL** key and select these event types with left mouse clicks:

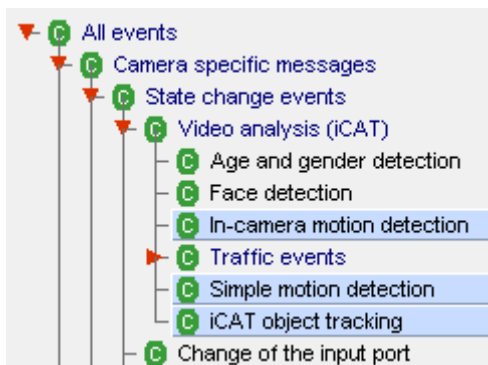

You can also search for events which have been **acknowledged** or **not acknowledged** by selecting the appropriate check box.

5. With the **Number of records** options you can also select how many search results should be displayed.
6. After setting different search criteria and filters press the **Search** button to display the results.

By clicking the **Next** button you can step forward in the result list and with **Previous** button you can step backwards.

9.2.1 Exporting events

You can also export the search results into an HTML file different file types:

1. In the **Event search** dialog press the **HTML export...Export...** button which opens the events export dialog.

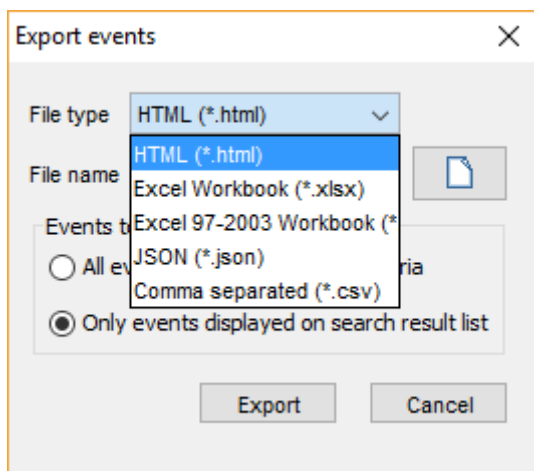

2. Select what file type you want to export the events to whereby the following types are available:
 - HTML (.html)
 - Excel Workbook (.xlsx)
 - Excel 97-2003 Workbook (.xls)
 - JSON (.json)
 - Comma separated values (.csv)
3. Select whether you want to export **All events according to filter criteria** or **Only events display on search result list** and enter a file name.
4. Press **Export**. Now the corresponding file is created and you can open and use it in a program of your choice.

9.2.2 Exporting event-related recordings

You can export event-related video recordings from the **Event search** dialog. For each event that has recording associated a separate video file is created. The file name is composed of the event ID, date, time, and event type. The export can be done in 2 formats: AVI (DivX) and SAFE (see also 7.3 *Exporting recordings (images and video sequences)* on page 79).

Here is how you can do that:

1. In the **Event search** dialog press the **Video export...** button, which opens an export dialog.
2. Select the directory where the exported video files are to be stored and choose whether you want to export only the events displayed in current search list or all events matching the filter criteria.

You can also supply the pre- and post-event time to be exported.

Select the video format.

3. Press **Export**. Now a separate video file is created for each event that has a recording. At the end a summary dialog shows how many files have been create and what is their total size.

9.3 Generating an event statistics report

Observer allows you to create an event statistics report in MS Excel XLS format.

To create a statistics report file, follow these steps:

1. Choose **Event statistics export...** from the **Events** menu. This brings up the **Event statistics export** dialog:

2. Select for which **Start time**, **Time period** and time **Resolution** you want to create the report. Also you can filter according to **Event type**, **Camera** and **User** (multiple selection by holding down the **CTRL** key while clicking is supported for all filters). If you do not select any values for Event filter, then a summary statistic report will be created.
3. Press **OK** to start creating the report file. You will be prompted for a file name where the report should be stored.
4. Open the created file in MS Excel. With the data, you can also create graphics like the following one (motion detection statistics for one day):

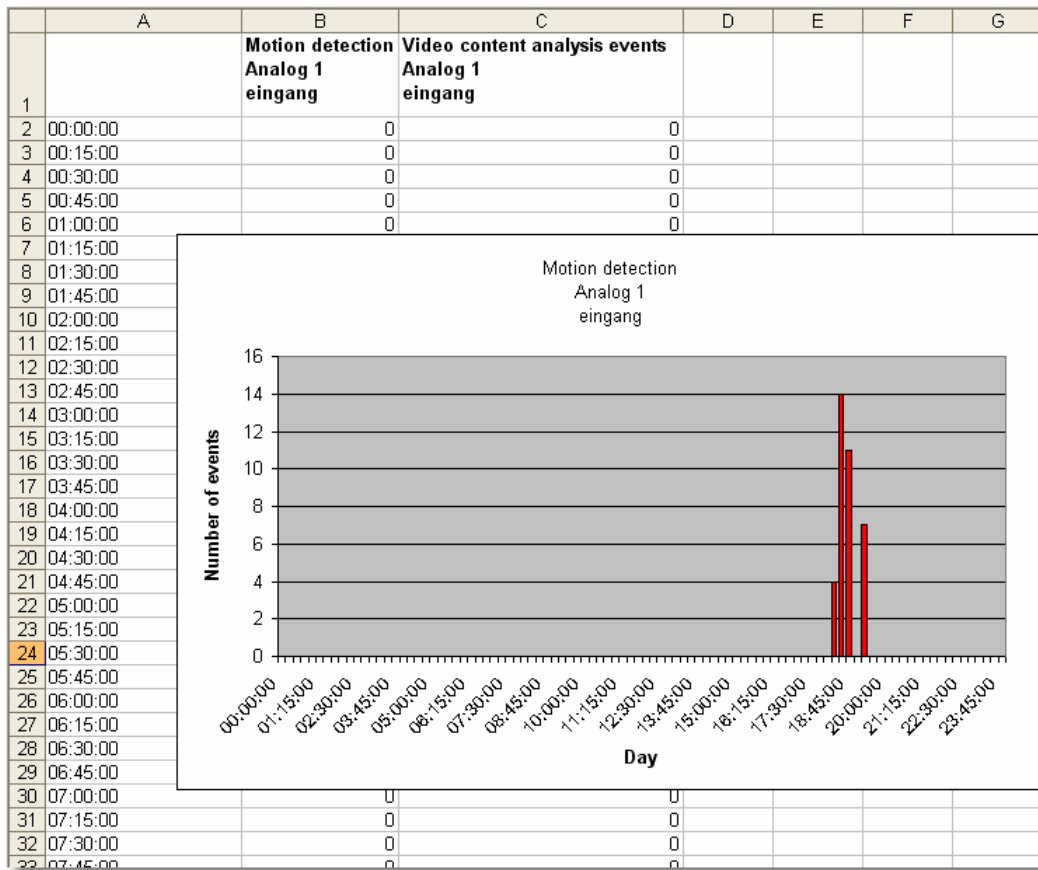

9.4 Receiving notification on events

Observer can be configured flexibly to notify users on various event types and by various channels.

The event types for defining notifications are:

- System malfunction events (e.g. storage failures)
- System information events (e.g. example user login and logout)
- Camera-related events
 - o Camera malfunction events (e.g. camera is not accessible)
 - o Camera in-picture events (e.g. motion detection, video analytics object triggers)

The notification channels are:

- Event list of the client
- Email
- SMS

For each of the above event types the notification channels can be enabled/disabled in the user privileges and camera access rights (see 5.2 *Setting general user privileges* on page 46 for details on how to define privileges and rights).

Please note that the notification channels can be defined on a user or on a group level. Likewise the camera-related notifications can be defined on a camera or a camera group level.

Please note: In order to receive emails, the email address must be correctly defined in the user properties. Also the server must be correctly configured and must also have access to an email router for sending emails. For receiving SMS an SMS sending device must be configured at the server. See *Netavis Observer Server Installation and Administration* for details.

9.4.1 Receiving Email notification with alarm image on camera events

Here you learn how to set up email notification with alarm image on camera motion detection or video analytics events:

1. In the **User admin** dialog select the user for which you want to define the email notification and enter the correct email address (see *5.1 Creating a new user account* on page 44).
2. Continue to the **Camera access rights** by pushing the **Next** button and then select the camera or group for which you want to define the notification settings and enable the right **Events: Sending email about in-picture events (e.g. motion detection, video analysis)**.
If the user should also be informed about camera failures you can also enable **Events: Sending email about camera malfunction events** (see *5.2 Setting general user privileges* on page 46 and *5.3 Setting camera access rights* on page 50).
3. Define and enable a motion detection or iCat definition (see *15.3 Setting up a camera for video analytics with iCat* on page 146).
4. Check that the iCat video analytics or motion detection definition has an active recording enabled (either continuous or event-based). Please refer to *15.3.16 Scheduling iCat video analytics and recordings* on page 164.
5. Make sure that for the motion detection or iCat definition the event generation is enabled (the checkbox **Save event in event list** is marked in the Scheduling dialog) and that it is not suppressed in the iCat event definition itself.

When you have setup all these things the user should receive an email with an attached alarm image on every event.

10 Working with PTZ cameras

Observer features the control of PTZ cameras (pan/tilt/zoom).

Note: To configure and work with PTZ cameras, you need the corresponding user privileges and camera access rights (see 5.2 *Setting general user privileges* on page 46 and 5.3 *Setting camera access rights* on page 50). If you find that you do not have the authorizations you need, please contact your Observer administrator.

10.1 Setting up a PTZ camera

Setting up a PTZ camera is the same procedure as setting up a camera without PTZ functionality (4 *Setting up cameras* on page 31).

The user must possess the user-specific camera authorizations (see 5.3 *Setting camera access rights* on page 50) to permit PTZ access.

10.2 Defining fixed PTZ positions

1. Choose **PTZ** from the **System administration** menu. This opens the **PTZ** dialog.
2. From the camera tree, select the PTZ camera whose PTZ positions you want to program.
3. In the menu select **Add new definition**.
4. In the **Name** field enter a designation for the position and then use the **PTZ control elements** to move to the desired position (detailed explanation of control elements in Section 10.4 *Controlling PTZ cameras* on page 101):
5. Click on **Save** to save your configuration. Then you can repeat steps 3 to 5 to define additional PTZ positions.
6. From the **Online Monitor** you can select these predefined positions (see below).
7. Double-clicking on one of the predefined positions lets you position the camera. Proceed similarly in order to change positions.

10.3 Defining PTZ routes

In addition to individual PTZ positions, you can also define position routes that can be followed on command. A position route consists of a list of PTZ positions that are automatically, sequentially followed and a duration per position.

Define a PTZ route as follows:

1. Choose **PTZ** from the **System administration** menu. This opens the **PTZ** dialog.
2. From the camera tree, select the PTZ camera whose PTZ route you want to program.
3. If you have not already defined PTZ positions that now appear in the list, or you can create new positions now. See the previous section for defining new positions.
4. Click on the **Next** button at the bottom right. This takes you to the **Routes** dialog, whose layout resembles the **Positions** dialog above.
5. In the menu select **Add new definition**.

6. In the **Name** field enter a designation for the route. Optionally you can enter a description.
7. Click on **Next** to move to the **Route details** dialog:

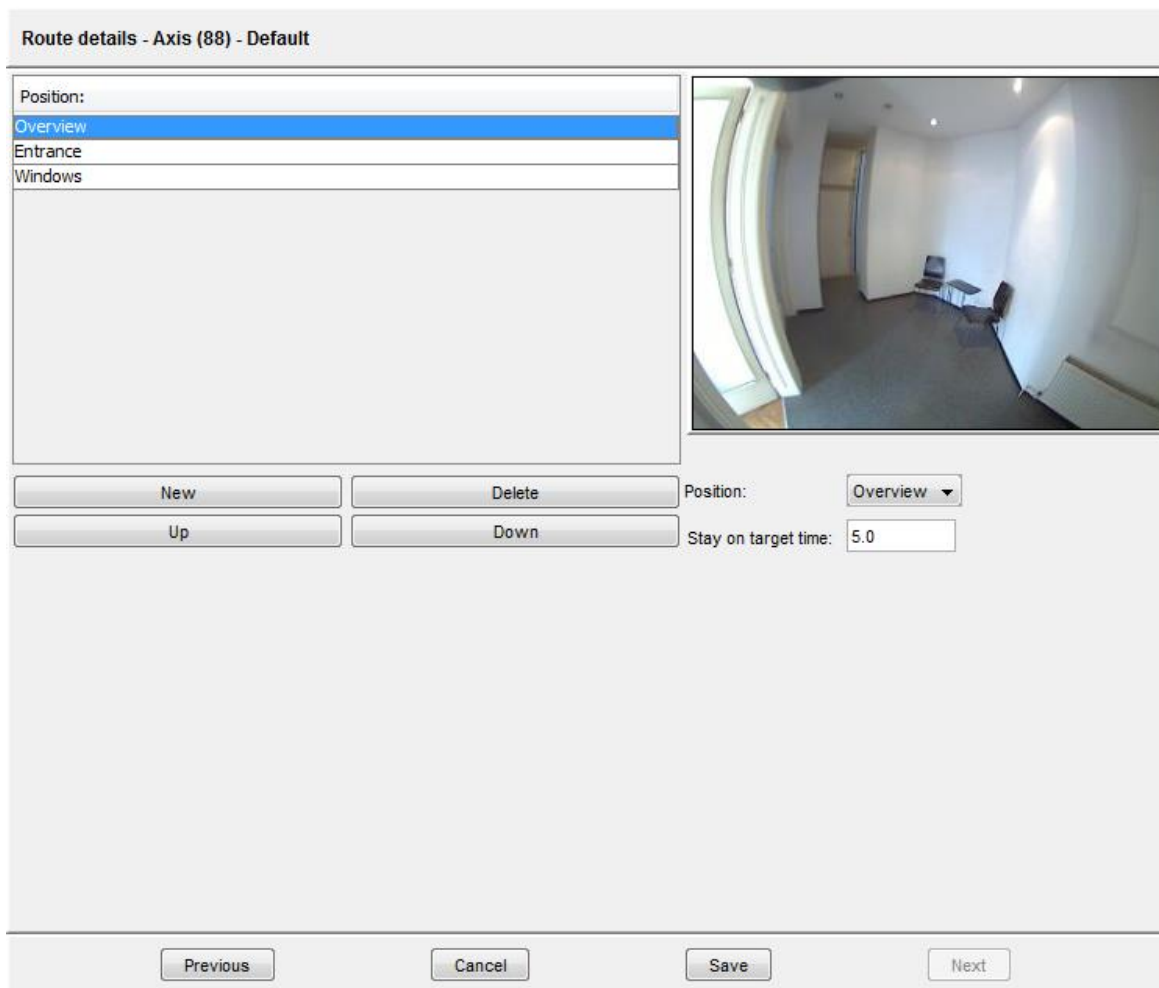



8. Click the **New** button to create a new entry in the **Position** list of the route and select a position from the list of predefined positions via the **Position** popup menu.
9. In the **Time at position** field, enter the duration in seconds that the camera is to spend at the position. Note that this time includes the positioning time of the camera.
10. Repeat Steps 8 and 9 for each entry in the position list.
11. You can change the sequence within the position list by selecting a position and then clicking the **Up** or **Down** button. You can remove an entry from the **Positions** list by selecting it and then pressing the **Delete** button.
12. Click the **Save** button to save your route or **Cancel** to discard changes.

You can select the saved route in the Online Monitor via the **PTZ** menu of the view port control menu of the PTZ camera. Proceed similarly to modify a route.

10.4 Controlling PTZ cameras

10.4.1 Controlling PTZ cameras in the Online Monitor

Control PTZ cameras as follows:

1. Select the **Online Monitor**.
2. Switch to a view that contains a PTZ camera (how to create views and assign cameras is covered in section 6 *Using the Online Monitor* on page 54).
3. In the view port of the PTZ camera push the PTZ start button  or choose **PTZ->Activate PTZ** from the view port control menu. The icon  of the view port indicates that you have PTZ control over the camera.



Note: For each user a PTZ priority and allocation timeouts can be defined (see 5.1 *Creating a new user account* on page 44). If another user with equal or higher priority has already assumed PTZ control over the camera, you will be denied control and notified in a window. Then you need to wait until this user surrenders control or reaches his timeout. A user with a higher PTZ priority can take away PTZ control from a user with lower PTZ priority.

Direct PTZ control inside a view port

You have several options for directly controlling PTZ cams: The various modes can be selected via **PTZ->PTZ control mode** in the view port control menu. The default setting is **Continuous** mode and **Center on click**. As an alternate mode also an operation via a **Crosshair** is available.

Continuous mode (available for joystick and mouse operation): Click the mouse in the view port and drag it in the direction where you want the PTZ cam to move. A red dot marks the origin of the movement and a red line indicates how fast the movement is. When you release the mouse, the movement will stop (though depending on the camera and network it is possible that there is a small delay).



Center on Click: A single mouse click somewhere in the view port commands the camera to center on the mouse click location.

Zooming: Zooming is available via the mouse wheel: zoom-in (forward scroll) and zoom-out (backward scroll). The amount of the zoom will be indicated by 3 red dots after the mouse is released:

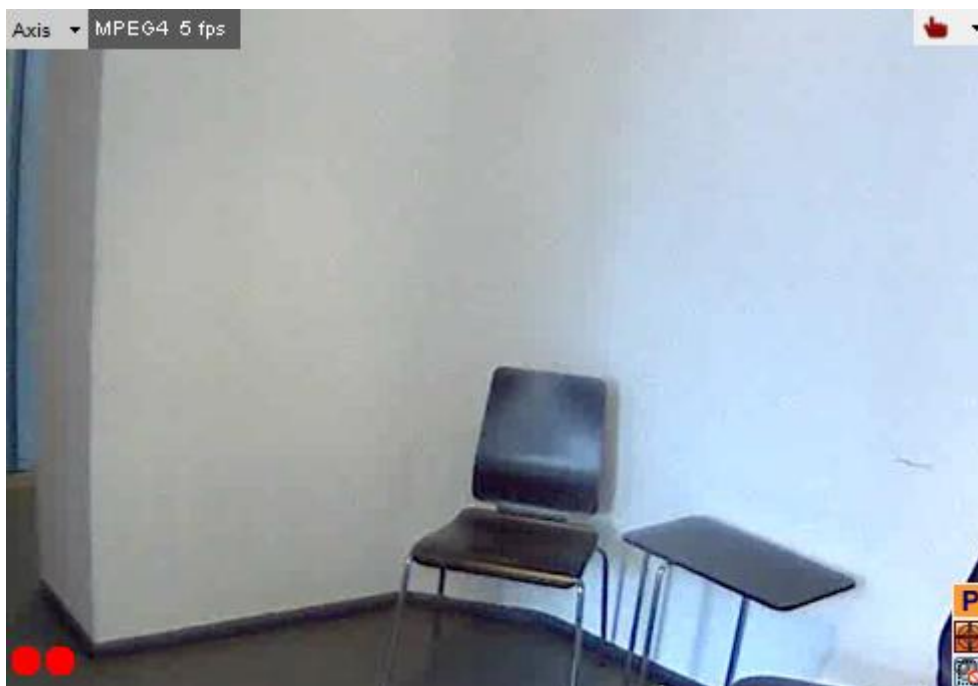

Please note: When PTZ control is enabled, any mouse actions are taken for PTZ control. In order to control the client-based view port zooming (see 7.2.3 *Zooming in a view port and in archive recordings* on page 76), hold down the **CTRL** key while using the mouse.

Crosshair: When this mode is enabled, a crosshair for relative control mode is shown in the view port:

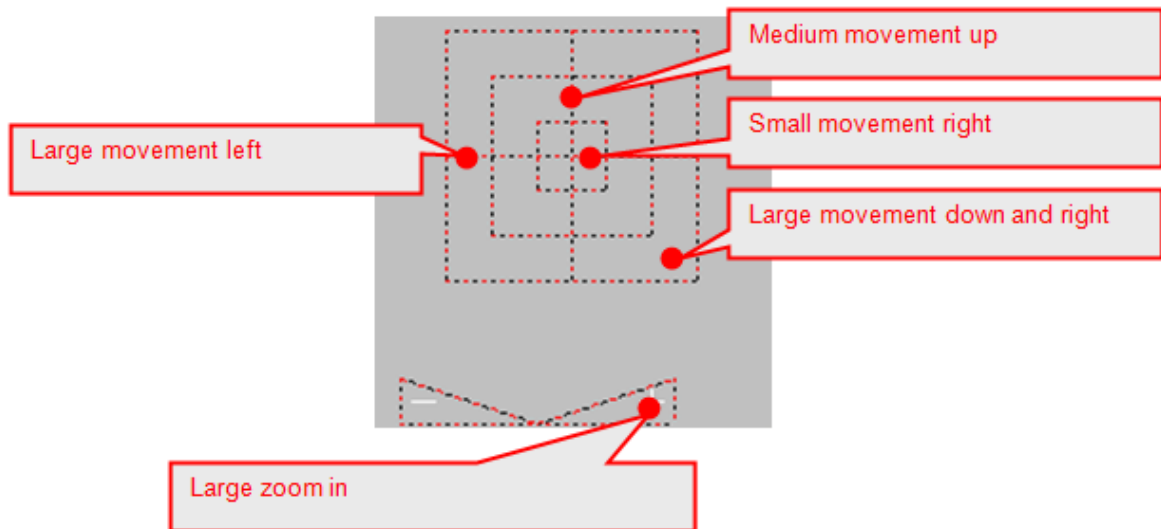

Controlling PTZ cameras with a joystick:

The locally installed version of Observer is able to handle USB joysticks as input device from Java VM 1.4 and newer (for information on how to install the application version locally please refer to *2.2 Working with the installed Observer client* on page 12).

The joystick can be used for panning, tilting the camera, while its buttons for zoom-in and zoom-out operations (which button is used for which operation is assigned during calibration). The joystick must be calibrated before use (found in the System Information menu, beside the language change menu).

Please note: In order for the joystick support to work the Java version (32-bit or 64-bit) installed on the client PC has to match the system's processor architecture.

Jump to a predefined PTZ position and follow PTZ routes

1. To send a camera to a predefined PTZ position, activate the PTZ control, right-click to open the context menu and select a position from the list at the top of the menu (see *10.2 Defining fixed PTZ positions* on page 100).

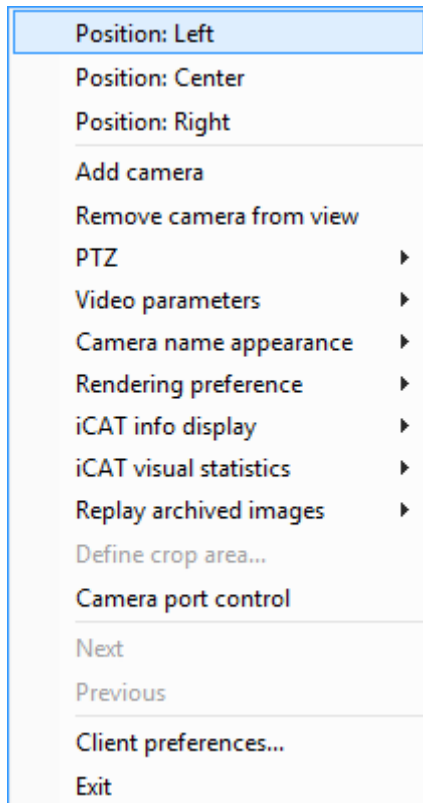

2. To automatically follow a predefined PTZ route choose it from **PTZ->Select PTZ route** in the view port control menu of the PTZ camera.
3. In the view port control menu of the PTZ camera, click **PTZ->Select PTZ route->Stop route** to stop control of the PTZ camera.

Stop PTZ control

You can stop PTZ control by pushing the  button or deselect **PTZ->Activate PTZ** control in the view port control menu.

Note: Please do not forget to stop PTZ control; otherwise other users cannot assume control. When you end the Observer client, all PTZ control is automatically released. For further details on user-specific PTZ priorities and timeouts please refer to *5.1 Creating a new user account* on page 44.

10.4.2 Controlling PTZ cameras with motion detection events

It is possible to automatically control PTZ cameras with motion detection events. Please refer to *8.1.4 Controlling PTZ cameras with motion detection events* on page 88.

10.4.3 Scheduling PTZ routes

It is possible to schedule time intervals for PTZ camera to follow predefined routes.

Note: Before you can schedule a route you first must define the route (please refer to *10.3 Defining PTZ routes* on page 100).

To schedule a PTZ route, follow these steps:

1. Choose **Camera admin** from the **System administration** menu. This opens the **Camera admin** dialog.
2. Select a PTZ camera.
3. Press the **Next** button to go to the **Scheduling** dialog.
4. In the menu select **Modify selected camera or group**.
5. Click the **Add** button to add a programming slot to the **Time Intervals field**.
6. Click the **Change** button (now enabled) for a popup menu; select **PTZ route**. This will show the PTZ scheduling settings (see above).
7. Set the **time settings** according to your needs.
8. Select the route from the **Route Name** pop-up menu (in the example above we selected Route 1).
9. Click on **Save** to store the scheduling settings.

Note: You can add several PTZ route schedules for a single camera. This means that you can follow different routes at different times.

11 Administrating Observer servers

This chapter describes how to

- get status information about running Observer servers,
- set server parameters,
- start/stop servers,
- administrate external NEA storages

Further information about administrating servers you find in the document *Netavis Observer Server Installation and Administration*.

11.1 Server system information and restarting

Observer offers 2 sets of status information of the running servers in a network.

- The server load display in the main client window
- The System information dialog in the Admin area

11.1.1 Server load display

The server load display is located in the status bar of the main client window and shows the following information:

CPU: xx %	Server CPU load in percent. This display is updated every 5 seconds.
IDB: xx % xx KB/s	Load of Image database (IDB) engine: This parameter shows how busy the server is with saving video data on storage. The actual video data storage rate is displayed below the percent value in Megabytes/sec or Kilobytes/sec. The IDB display does not appear if the server does not record. Note that the IDB load also increases when the server removes video data when the storage is full or recording time limits are reached. IDB details are updated once a minute.
OVR: xx %	Overloaded state of the IDB engine: The IDB engine is overloaded if the server receives more video data from the cameras than it can record (save on storage). In this case the server will drop frames. OVR shows the percent of dropped frames. If the label OVR does not appear then the server can save every incoming frame.
SWP: xx MB	Swapping: This display appears if the server starts heavy swapping, which means that the amount of main memory of the server is insufficient. If this is situation persists, the server must be extended with additional RAM.

11.1.2 System information dialog

1. Choose **System information** from the **System administration** menu. This opens the **System information** dialog.

The table shows the connected servers and their state:

Name shows the name of the server and the Observer version running.

State shows whether the server is running and if there is a failure.

License shows the license of the Observer server (or the remaining days if the system is in license-less mode):

- Alphanumeric sequence: This is the Machine ID used for licensing the server
- OBS: represents the basic functionality
- Server network licensing:
 - UNW: unlimited number of connected servers
 - LNW: max. 3 connected servers
- Licensed features:
 - SNMP: SNMP support
 - EIDB: Encrypted image database
 - AD: Active Directory/LDAP support
 - ABS: ABS (Adaptive Balanced Streaming) transcoding for low-bandwidth connections
 - CAM: shows the number of total camera licenses. If the number contains an “R” then it is a floating license from a remote licensing server. If the number of cameras exceeds the license limit, then in parentheses first the number of disabled cameras is shown and then, after a slash, the number of allowed licensed cameras.
 - USR: shows the number of total user licenses. If the number contains an “R” then it is a floating license from a remote licensing server.
 - SNAP: SNAP XML integration interface
 - LNT: Layout Navigation
 - iCat: iCat video analytics
 - SAB: Camera sabotage detection
 - IPAD: Client for iPad
 - URL: SNAP URL integration interface
 - VW: Video wall control
 - V4W: Video4Web
 - SMPH: Client for Smartphone & Tablet
 - TRF: iCat Traffic
 - NPR: iCat Number Plate Recognition
 - WEBC: Mobile Client
 - EDS: External Devices
 - FACE: iCat Face Detection

With Observer 4.0 to 4.6 you can display the current license key string by entering the following URL in a web browser **http://IP-address-of-your-server/arms/servlet/BrowserServlet?cmd=showlicensekey**.

For further information about licensing please refer to the manual *Netavis Observer Server Installation and Administration*.

Archive shows the sum of fps and Kbytes per second of archiving on that host.

Monitor shows the sum of fps and Kbytes per second of all logged in users.

Please note that you usually only see the status of your server. If you want to monitor the status of other Observer servers as well, you have to make other servers known to your server (please refer to *12 Working with interconnected Observer servers* on page 117).

- To show the details of a server, double click an entry or select a server in the table and then choose **Details** from the **System** menu. Now you see detailed information for the selected server with hard disk partitions and their state.

Partition ctrl: shows the number of the hard disk controller; **dev:** shows the hard disk number on the controller. On the screen dump we have 5 disks on 3 controllers.

Type indicates the type of the partition: **DB** is a database holding configuration and event data and **I** is an image partition that holds the actual video image data.

Status indicates whether there is a failure on the partition. Such a failure needs to be reported to your Observer Administrator.

Capacity indicates the size of the partition in MB.

Used % shows how much space of the partition is used.

- Click on the **Back** button to leave the server details dialog and go back to the list of servers.

11.1.3 Restarting Observer and rebooting the server

- Choose **System information** from the **System administration** menu. This opens the **System information** dialog.
- Select a server in the table. In the **System** menu you have the following actions available:

Stop Observer system: This stops all video system processes but does not shut down the server.

Switch off server: This shuts the server down.

Reboot server: This reboots the server.

11.2 Setting Observer server parameters

Observer allows you to set several server parameters. To access them, follow these steps:

- Choose **Host admin** from the **System administration** menu. This opens the **Host admin** dialog.
- Select your own server indicated by bold face (default is **netavis**). Here you see the Hostname, Network name or IP address and Observer Host ID of your server (are read only). The Observer Host ID is needed for working with distributed Observer server (see next section).

3. If this server is cooperating with other servers, then the settings for synchronization group may be relevant (see also *12 Working with interconnected Observer servers* on page 117):

If this server should be part of a synchronization group then enter the name of the synchronization group in the field **Name of synchronization group**. If this server should be the main node of the synchronization group, then select the check box **main node of the sync group**. Please refer to *12 Working with interconnected Observer servers* on page for a general explanation of synchronization groups.

Please note: Modification of configuration data is only possible at the main node of the synchronization group and not at the secondary nodes (as they will be updated by the main node automatically). As long as there is no main node in the sync group (which may happen during set up of the sync group) no modification is possible at all.

4. As of Observer 4.7 a direct interface to Netavis sMart Data Warehouse is available. It can be enabled by checking the **Allow sMart Data Warehouse connection** checkbox and then setting up (and confirming) a **password** for the interface. This password then needs to be entered in the corresponding Netavis sMart Data Warehouse configuration.
5. Click on the **Next** button. Now you see the Server **Parameters** dialog. The following settings are available:

Field label	Description
Event storage period (days)	Defines how many days events are stored. Any events that are older than these days will be deleted from the event database.
Max number of events stored on server	Defines how many events can be stored in the event database. For each event more than the defined max. number of events the oldest event will be deleted. Please note that both settings, the storage period and the max. number of events, together constrain the event database.
Server timezone abbreviation	Defines the server timezone. Available values are:

Field label	Description
	<p>GMT, Greenwich Mean Time CET, Central European Time GMT+1 MIT, Pacific/Apia GMT-11 HST, Hawaiian Standard Time GMT-10 AST, America/Anchorage GMT-9 PST, Pacific GMT-8 MST, Mountain GMT-7 CST, Central GMT-6 EST, Eastern GMT-5 PRT, America/Puerto_Rico GMT-4 CNT, America/St_Johns GMT-3.5 AGT, America/Buenos_Aires GMT-3 ART, Africa/Cairo GMT+2 EET, Europe/Istanbul GMT+2 EAT, Africa/Addis_Ababa GMT+3 MET, Asia/Tehran GMT+3.5 NET, Asia/Yerevan GMT+4 PLT, Asia/Karachi GMT+5 IST, Asia/Calcutta GMT+5.5 BST, Asia/Dacca GMT+6 VST, Asia/Saigon GMT+7 CTT, Asia/Shanghai GMT+8 JST, Asia/Tokyo GMT+9 ACT, Australia/Darwin GMT+9.5 AET, Australia/Sydney GMT+10 SST, Pacific/Guadalcanal GMT+11 NST, Pacific/Auckland GMT+12</p>
Timeout for IP cameras (sec)	<p>Defines the time the server waits to receive a response from a camera and then displays the "Camera not responding" message in the Online Monitor (whereby a maximum value of 60 seconds can be set). Note that also other error conditions can trigger the "Camera not responding" message, so this message might also be shown sooner than the configured timeout period (e.g. when there's no route to host).</p>
Retry count for IP cameras, after which an event is generated	<p>Defines the number of connection retries after which the server raises a "Camera not reachable" event.</p>
Maximum login time for the "guest" user (sec)	<p>Defines the time after which the guest user is forced to logout. If the value is 0, then the guest is never forced to logout.</p>
Timeout for server-server communication (sec)	<p>Defines the time after which an event "Connection lost to server ..." is generated and the cameras mounted from that server disappear from the camera tree (only the root element of the mounted camera tree remains visible,</p>

Field label	Description
	painted in red).
Server network address for camera access	This setting is only important for IP cameras that must actively access the server (e.g. for FTP upload with in-camera motion detection) and only when the server is not accessible by the cameras at its set IP address but at a different address (e.g. due to address mapping). Per default this address always reflects the IP address of the server. You can enter an IP address or a network name.
List of IP addresses from which URL control is enabled	<p>URL control is one way to enable third-party applications to start actions via URL-encoded strings (send http GET request to an Observer server). The server upon receiving these special URL requests executes the actions as if they would have been generated internally.</p> <p>URL control is only enabled for computers whose IP addresses are entered in this fields (comma separated list). All other requests are blocked. Please refer to the <i>Release Notes</i> for further details on URL control.</p>
ABS transcoding bandwidth limit for live view video streams (kbit/s)	<p>Bandwidth limit per session for transcoded outgoing live view streams (ABS). Zero means no transcoding and no limit for live view video streams. Please read <i>2.6 Observer Transcoding for low-bandwidth client-server connections (ABS)</i> on page 27 for choosing the best limit values.</p> <p>Note: ABS-Transcoding is only available in the Netavis Observer client and is not supported by the Mobile Client, Layout Navigation or other tools. In a single-server setup it is necessary to re-start the streams (e.g. by switching from Online Monitor to Archive Player and back) for the changes to take effect. In a distributed NCS-NUS setup and when connected to the NCS then a client restart is needed for the changes to take effect.</p>
ABS transcoding bandwidth limit for archive playback video streams (kbit/s)	<p>Bandwidth limit per session for transcoded outgoing archive playback streams (ABS). Zero means no transcoding and no limit for archive playback streams. Please read <i>2.6 Observer Transcoding for low-bandwidth client-server connections (ABS)</i> on page 27 for choosing the best limit values.</p> <p>Note: See the note for "Transcoding bandwidth limit for live view video streams (kbit/s)".</p>

Field label	Description
ABS transcoding bandwidth limit for archive export streams (kbit/s)	<p>Bandwidth limit per session for transcoded outgoing archive export streams (ABS). Zero means no transcoding and no limit for archive export. Please read <i>2.6 Observer Transcoding for low-bandwidth client-server connections (ABS)</i> on page 27 for choosing the best limit values.</p> <p>Note: See the note for "Transcoding bandwidth limit for live view video streams (kbit/s)".</p>
IP address of network interface (NIC) for bandwidth limitation	<p>IP address of the network interface (NIC) for which bandwidth limitation is applied. If zero, then the bandwidth limit is applied in total for all available network interfaces. If transcoding is switched on, then it will only be applied to connections of this NIC.</p> <p>If you enter the keyword NUS instead of the IP address of the NIC then only traffic to a NUS (Observer user server) is transcoded. Local client connections to this server will not be transcoded. It also works this way if the server has only 1 NIC for all traffic to cameras, local clients and a NUS.</p>
Total outgoing bandwidth limit (kbit/s)	<p>Total bandwidth limit for all outgoing connections of the specified network interface (NIC).</p>
RTSP streaming port	<p>Port number generally used for RTSP communication (e.g. for some MPEG cameras).</p> <p>Please note that modifying the value here does not change the RTSP port setting in the cameras. The cameras need to be configured separately for the RTSP port.</p>
Image database AES encryption (0=no encryption, 1 or 2=encryption)	<p>This defines whether the image data are encrypted with AES.</p> <p>Value 0 switches off encryption (default).</p> <p>Entering the value 1 or 2 will switch on AES encryption of the video recording. Value 1 means the system will store the encryption key on a local server disk.</p> <p>Value 2 will store the key on a USB device (formatted with FAT32), which has to be plugged into the server. If the device is not accessible, then archive access is not possible. Prior to inserting the USB device, a writable directory "nek" must be created on the device (this can be done under Windows, for example). Observer will search for this directory and store the key file in it. After the USB device is detected and the key has been written to it the first time, an event with following text is generated: "IDB encryption started, USB device can be removed now for creating</p>

Field label	Description
	<p>backup copy". At this time the USB device can be removed from the server, and a backup copy of the directory "nek" can be created. Note that the stick must be inserted again before any archive query is started.</p> <p>Warning: Loss of the encryption key stored on the USB device will make archive access impossible! Also, encryption needs much more CPU power than no encryption (see also <i>1.3 Observer data security</i> on page 7).</p>
<p>Length of alarm recording image database in days</p>	<p>In case continuous recording is run in parallel to an iCat or event-triggered recording this option defines the minimum number of days the iCat or event-triggered recordings are stored (regardless of how long the continuous recordings are stored).</p> <p>Warning: If there is not enough space available for all recordings then even iCat or event-triggered recordings may be deleted sooner than configured here. (Please see <i>7.1.4 Operation of the Observer dynamic storage management</i> on page 72 for further information.)</p>
<p>Limit for manually protected recordings in days</p>	<p>Any delete-protected recordings older than this time limit (number of days) will be deleted automatically.</p>
<p>Name of logout PTZ position</p>	<p>Name of a PTZ position where all PTZ cameras which have a position configured with that name will be positioned when a user logs out. If left empty the feature is not activated.</p>
<p>Heat map export period</p>	<p>Interval in which heat map data is exported. Possible options are:</p> <ul style="list-style-type: none"> • hourly • daily
<p>Heat map data reset method</p>	<p>Per default iCat heat map data is never reset. However since NetavisObserver 4.6 it is possible to automatically reset all heat map data:</p> <ul style="list-style-type: none"> • daily reset: day:hour (concrete example is day:07 for daily resets at 7AM) • weekly reset: week:week_day:hour (concrete example is week:2:07 for weekly resets on Mondays at 7AM whereby week_day is a number where Sunday = 1 and Saturday = 7) • monthly reset: month:day_of_month:hour (concrete

Field label	Description
	<p>example is month:01:07 for monthly resets on the first of the month at 7AM)</p> <p>Note: This setting only affects the current host. This means that in a system with multiple Observer servers this option has to be set on all servers (NCS and NUS) individually to achieve a consistent result.</p>
Max value for normalizing count	<p>The maximum value (up to 8 digits) for normalizing count heat maps for all cameras on this host.</p> <p>Note: See the note for "Heat map statistics reset method".</p>
Max value for normalizing speed	<p>The maximum value (up to 8 digits) for normalizing speed heat maps for all cameras on this host.</p> <p>Note: See the note for "Heat map statistics reset method".</p>
Max value for normalizing stopped objects	<p>The maximum value (up to 8 digits) for normalizing stopped objects heat maps for all cameras on this host.</p> <p>Note: See the note for "Heat map statistics reset method".</p>
Max value for normalizing object stopping time	<p>The maximum value (up to 8 digits) for normalizing stopping time heat maps for all cameras on this host.</p> <p>Note: See the note for "Heat map statistics reset method".</p>
Max number of parallel transcoders	<p>Defines the maximum number of parallel transcoders providing videostreams via SNAP URL.</p>
Ask for login reason	<p>If this value is set to 1 then all users have to document a reason for the login at the system.</p> <p>Note: If this option is enabled, then the user-specific ones are ignored.</p>
Minimum password length	<p>Minimum number of characters for user passwords.</p>
Minimum password complexity (0-3)	<p>The password complexity uses the following scoring mechanism:</p> <ul style="list-style-type: none"> • one digit, lower-case, upper-case, special character adds one to the score • the second digit, lower-case, upper-case, special

Field label	Description
	character adds another one to the score This can give a maximum value of 8 which corresponds to 100%. The current percentage is computed and the four levels (0-3) are at the boundaries of 25%, 50% and 75%.

6. To modify any of these values, select **Modify host** in the menu, set the values and then press **Save**.

12 Working with interconnected Observer servers

Observer allows you to work with the resources of interconnected (remote, distributed) Observer servers. You can import single cameras or whole groups of cameras from other Observer servers and you can also export your locally defined cameras to other Observer servers. You can work with remote cameras as if they would be local (e.g. you can also access their archive, modify their parameters or even add new cameras to remote sites). You can also define whether events should be propagated between servers.

A special feature are so called synchronization groups of servers. A synchronization group allows you to automatically synchronize server configuration data (like user configuration data and view configuration data) between servers.

Before you can do any of these things, you first have to make both servers known to each other. You can do that by adding the other server as remote server on each of the machines. The next section describes how to do that.

Note: In order for interconnected Observer servers to work together all of them have to run **exactly** the same version.

12.1 Basic concepts of distributed systems

12.1.1 Camera servers (NCS) and user servers (NUS)

In a single server system an Observer server does multiple things: store camera recordings, run iCat video analytics on camera streams, store events in the event database, handle user clients. In a bigger system with many cameras and users, a single server is not capable of doing all those things at once. Therefore multiple servers can be installed to handle the workload and the individual servers work in different roles:

Camera servers (NCS = Netavis Camera Server): A camera servers (NCS) mainly manages cameras, it stores recordings and optionally runs iCat video analytics on the video streams of the connected cameras. It also stores the events related to the connected cameras. A NCS usually does not serve any user clients directly but it offers its cameras to user servers for mounting.

User server (NUS = Netavis User Server): A user server handles user clients. It usually mounts cameras from multiple camera servers and also receives events from them. Thus a user connecting to a NUS can have access to the cameras of all camera servers. A user server usually does not manage any cameras directly and does not do any recording or any video analytics. However, it usually does store the events of all the mounted NCS in its central event database.

12.1.2 System Architectures

There are two key considerations which are important when planning distributed Netavis Observer systems:

- a. NUS servers must only import cameras directly from NCS servers and similarly NCS servers must only export cameras directly to NUS servers. So there should be no chains with one server importing cameras from a second server and in turn itself exporting cameras to a third server.

- b. No Netavis Observer server must import and simultaneously export cameras from the same server. So there should be no loops within the architecture.

12.2 Adding and defining a remote Observer server

1. Choose **Host admin** from the **System administration** menu. This opens the **Host admin** dialog.

In the menu select **Add host**.

Fill in the basic information of the desired remote Observer host (server):

Field label	Description
Hostname	This is the name you give to the remote Observer server. It does not necessarily have to match the actual name of the remote server.
Network name or IP address	This is the network name or IP address of the remote Observer server.
Comment	A descriptive text.
Observer Host ID	This is an internal ID that uniquely identifies the remote server. The ID of an Observer server can be obtained by reading its own entry under the Host Admin tab.

2. Now you can define what you want to do with the remote Observer server. Set options according to your requirements:

Field label	Description
Send local events to remote server	Check this option if you want that your local events are sent to the remote host.
Import of cameras from remote server enabled	Check this option if you want to import cameras from the remote server.
Export local cameras to remote server	Check this option if you want to export cameras of your server to the remote server. If this option is not enabled the remote server cannot access your cameras.
Monitor remote server status	Check this option if you want to monitor the status of the remote server in System information dialog.
Upgrade software on	Check this option if you want to allow automatic distributed

Field label	Description
remote server (=upgrade secondary node)	software upgrades of the remote server initiated by your current server. In such a case your current local server is the upgrade main node and the remote host the upgrade secondary node. For details about distributed upgrades please refer to the manual <i>Netavis Observer Server Installation and Administration</i> .
Accept software upgrades from remote server (=upgrade main node)	Check this option if you want to accept automatic distributed software upgrades of the current server (=secondary node) initiated by the remote server (=main node). In such a case your current local server is the upgrade secondary node and the remote host the upgrade main node. For details about distributed upgrades please refer to the manual <i>Netavis Observer Server Installation and Administration</i> .
Request license from remote server (=license main node)	<p>Check this option if your current Observer server should check out licenses from the remote server (=license main node). For details about floating network licenses please refer to the manual <i>Netavis Observer Server Installation and Administration</i>.</p> <p>Please note: After setting up a remote license server on a server that is in license-less mode, it is necessary to restart the client and the netavis services on the corresponding server.</p>
Use secure connection (HTTPS)	<p>Select this checkbox if you want to use an encrypted connection between the two servers (TLS HTTPS).</p> <p>Please note: Please be aware that an encrypted connection needs more CPU resources on both servers (see also <i>1.3 Observer data security</i> on page 7).</p>

- Click on **Save** to save your settings. Now you are ready to import cameras or camera groups from a remote Observer server.

Please note: As of Netavis Observer 5.1 it is also possible to search for all configured hosts via the search field at the top.

12.3 Working with cameras of another server

In order to work with cameras from another Observer server, the following prerequisites must be fulfilled:

- The servers must know of each other.
- The server that exports cameras must have the option **Export local cameras to remote server** set.

- The server that works with cameras of a remote server must have the option **Import of cameras from remote server enabled** set.

Note: See 12.2 *Adding and defining a remote Observer server* on page 118 for more details on how to configure these prerequisites.

12.3.1 Mounting cameras of another server

1. Open the **Camera admin** dialog from the **System administration** menu.
2. In the menu select **Mount remote camera or group**.
3. Select the remote Observer host from where you want to import cameras with the **Known remote machines** menu.

Now the **Remote host name** and **remote host IP address** of the remote Observer host are shown.

4. After clicking on **Cameras on remote host** the remote Observer host's camera tree is shown. You can then select a single camera or group to be imported.

Note: For remote cameras it is recommended to mount them per group rather than individually.

Confirm your selection by clicking on **Select**.

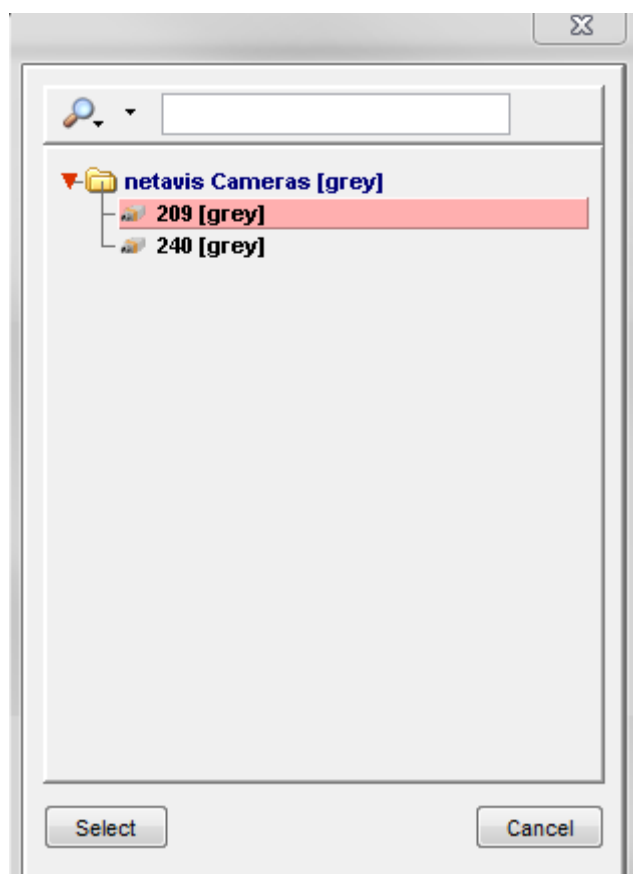

Now the camera tree shows this imported camera or group in **bold** with the name of the remote server in brackets (e.g. **209 [grey]**):

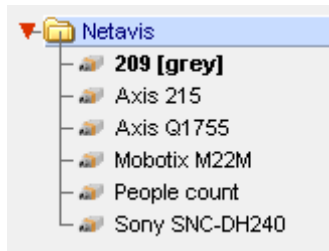

If the remote server is not reachable, the mounted cameras are not shown in the tree; only the top point of the mounted camera tree appears in red color.

- After you mount remote cameras you can work with them as if they would be connected to this server. You can access live streaming via the Online Monitor or you can access the archive. If you have the appropriate administrator rights you can also modify camera settings like PTZ, scheduling or motion detection.

Note: Only local cameras and remote camera groups can be duplicated. It is not possible to duplicate individually mounted remote cameras.

12.4 Working with events of remote servers

Observer servers can forward their events to other servers. Such forwarded events are stored in the event database of the generating server itself and also in the event database of the server(s) that receive the events.

Event entries in the event database of remote servers look the same as local events, they just start with the remote server's name and not with the name of the local server. The same kind of search and listing is available as with local events.

In order to receive events from another Observer server, the following prerequisites must be fulfilled:

- The servers must know of each other (*12.2 Adding and defining a remote Observer server on page 118*)
- The server that exports events must have the option **Send local events to remote server** set (*12.2 Adding and defining a remote Observer server on page 118*)

12.5 Monitoring remote servers

You can monitor the status of remote servers in the **System information** dialog (see *11.1 Server system information and restarting on page 107*). Before you can do that you have to tell your server to monitor the remote server by checking the option **Monitor remote server status** (see *12.2 Adding and defining a remote Observer server on page 118*).

12.6 Keeping multiple users servers in sync (synchronization groups)

In a larger system that requires multiple user servers (NUS) it can be cumbersome to manually keep all user configuration data synchronized between all user servers. Thus Observer offers the concept of so called synchronization groups.

In a synchronization group a main node user server automatically propagates its configuration data (complete user configuration data and camera configuration data, customer-specific resources like

icons and layout navigation data) to all the other user servers in the same group. Thus the main node user server is the single point of all user administration (in fact changes at secondary node servers are no longer possible). Any changes are automatically propagated to the other user servers in the same group.

Note: Servers included in a synchronization group must not have any locally added cameras and I/O devices!

Whenever a server is added as a secondary node to a synchronization group, it will automatically be synchronized with the data from the main node sync server.

The synchronization group settings can be modified in *11.2 Setting Observer server parameters* on page 109 (see *11.2 Setting Observer server parameters* on page 109).

Note: When a server is added as a secondary node to a synchronization group, any configuration data that does not exist on the main node server will be deleted and overwritten by the data of the main node server. So please be careful when you work with synchronization groups.

Also: When users connect to secondary node servers they cannot modify their user settings, this can only be done when they are connected to the main node user server. Thus layout navigation tool (LNT) project creation and icon uploads should always be done at the main node user server.

12.7 Distributed upgrades

When there are several Observer servers in a network upgrading servers to a newer release of Observer one by one can be a very cumbersome and time-consuming task. In order to ease this task, Observer offers an automatic distributed upgrade of all interconnected servers in a network.

Please refer to the manual *Netavis Observer Server Installation and Administration* for further details.

12.8 License allocation

Netavis Observer 5.0 introduced the license allocation feature which adds new flexibility for the management of large and distributed systems with a single license server.

Once a system has been configured to serve as a license main node the new **License allocation** tab becomes available in the **Host admin**:

localhost.localdomain (127.0.0.1)		License allocation	
License	Purchased	localhost.localdomain	ncs
CAM	20		10
USR	5		3
SNAP	5		
LNT	5		
iCAT	5		
SAB	20		
IPAD	0		
URL	5		
VW	5		
SNLT	0		
V4W	5		
SMPH	5		
TRF	3		
NPR	3		
DWHU	0		
DWHS	0		
DWHOB	0		
WEBC	5		
DPM	0		
EDS	5		
FACE	5		

Here are the steps for configuring the license allocation on the license main node:

1. Choose **Host admin** from the System administration menu. This opens the **Host admin** dialog.
2. Select the local host and choose **Modify host**.
3. Click on **Next** until you reach the **License allocation** tab shown above which provides an overview of the available licenses in the first two columns.
4. To limit the number of licenses a license secondary node (a server which requests licenses from this license main node) can obtain simply select the cell corresponding to the server and feature enter the desired number.
5. Click on **Save** to save your settings.

13 Active Directory Integration

You can configure your Observer server to import users from an Active Directory (AD)/LDAP server. In this case the users are maintained in AD/LDAP and users are imported (mapped) to a user group in Observer. The privileges and camera access rights of the users imported via Active Directory/LDAP can be defined with the Observer user group they belong to.

When the Observer server connects the Active Directory/LDAP server for the first time, it loads all matched users into the user group in Observer. These users are then cached in Observer (no user passwords are stored in Observer). Every 15 minutes the list of users is reloaded from the Active Directory/LDAP server.

Each time when a user that is defined in Active Directory/LDAP logs into Observer the password is checked (authenticated) with the Active Directory/LDAP server. This means that at login time a connection to the Active Directory/LDAP server has to be possible.

Note: No Observer-specific information is stored in Active Directory/LDAP.

Hint: As of Netavis Observer 5.1 Active Directory authentication is also support for the Layout Navigation, Mobile Client, SNAP integrations, Video4Web, and the VideoWall control application.

13.1 Configuring the users on the Active Directory server

All the users on the Active Directory server which should have access to *Observer* must be members of the group which will be imported by *Observer* (though of course they can also be members of additional other groups).

1. Create a new **Group** with the desired **Group Name** (e.g. *Observer4*), **Group Scope** set to *Global*, and the **Group type** set to *Security*.

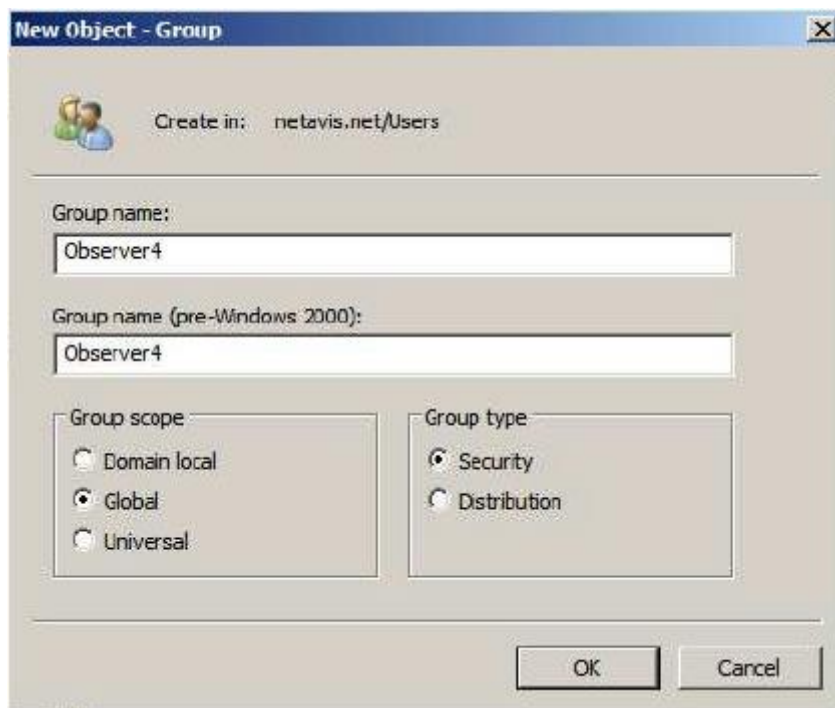

2. Add the desired users to the previously created group.

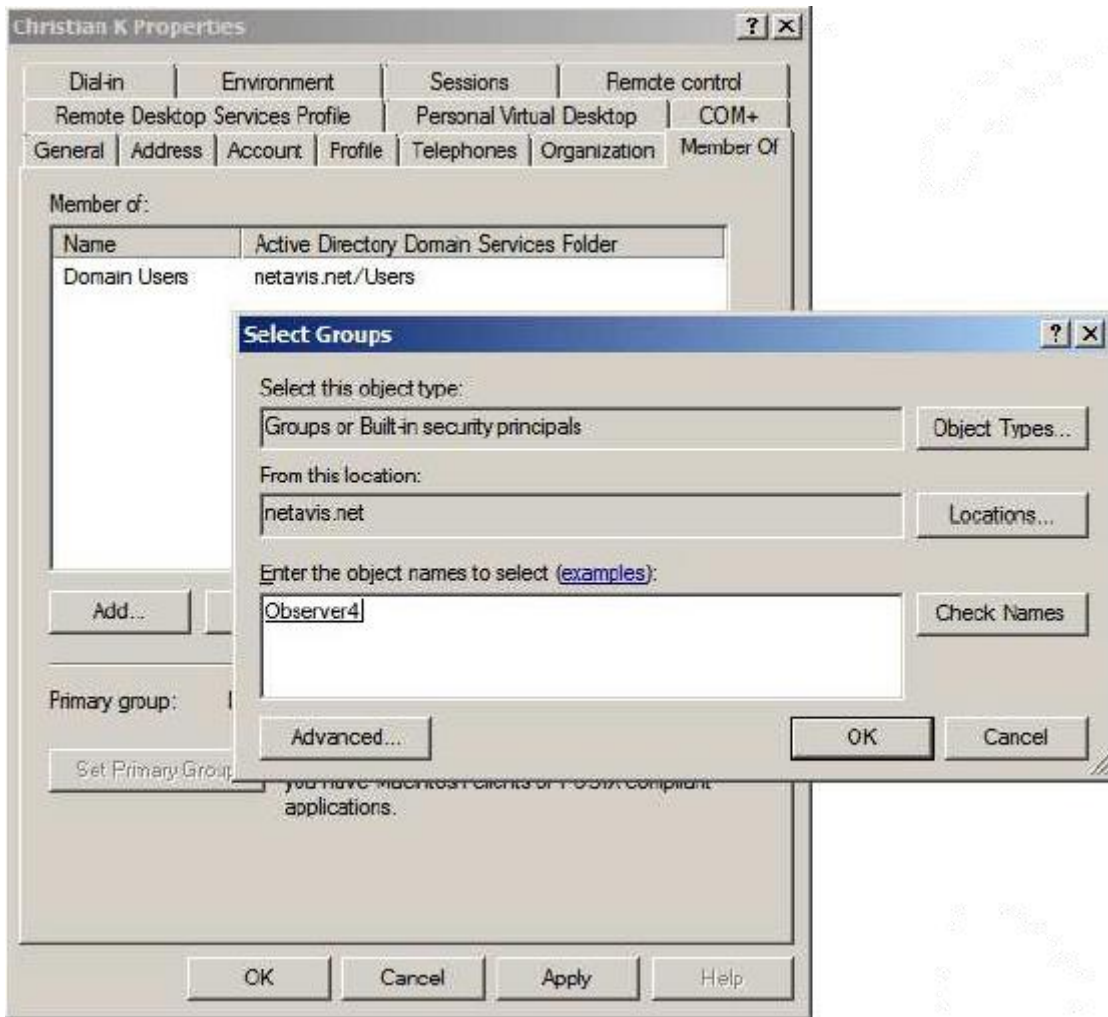

13.2 Configuring Observer

Now Observer must be configured to access and use the Active Directory server:

1. Open the **Host Admin**, select the current Host, and click **Next** until you reach the **Active Directory configuration** page.
2. Click on the **New** button below the Remote servers list to add a new Active Directory configuration.

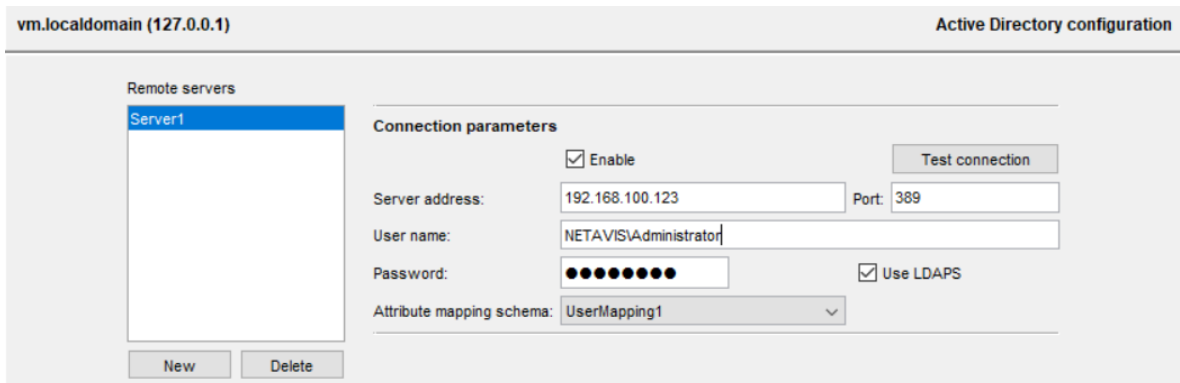

3. Configure the **Connection parameters**:
 - a. **Enable** the configuration by checking the corresponding checkbox.
 - b. Enter the **Server address** (IP address) and **Port** (the standard port is 389) of the Active Directory server.
 - c. Enter the **User name** (including the name of the Active Directory server, e.g. *NETAVIS\Administrator*) and **Password**.
 - d. Select whether **LDAPS** should be used.
- Note:** LDAPS servers with self-signed certificates are not supported.
- e. You can test the entered configuration with the **Test connection** button.
 4. Select a previously defined **Attribute mapping schema** or create a new one by choosing **Edit...** and then clicking on **New**. These are the attributes which will be imported from Active Directory to Observer:
 - **Login name tag** (mandatory): Set it to *cn*(users login with their common name: e.g. John Doe) or *sAMAccountName* (users login with their account name: e.g. john).
 - **Name tag** (mandatory): Set it to *displayName*.
 - **Email tag** (optional): Set it to *mail*.
 5. Press **Save**.
 6. Open the **User Admin**.
 7. For importing users from Active Directory you can either:
 - i. Select an existing group (though note that this group has to be empty!)
 - ii. Create a new group:
 - a. Choose **Add new group** from the **User/group** menu or the right mouse click menu.
 - b. Enter a **Group name** (e.g. *AD-Users*).
 - c. Check the **Users of this group are imported from Active Directory** checkbox.
 - d. Select one of the previously defined Active Directory servers.
 - e. Enter the **Active Directory group DN (Distinguished Name)** (e.g., *OU=Vienna,OU=Administrators,DC=netavis,DC=net*)
 - f. Make the appropriate adjustments on the **Privileges** and **Camera access rights** pages.
 8. Press **Save**.
 9. After Observer has finished synchronization with the Active Directory server (which may take up to two minutes) the users configured there will appear under the previously set **Observer group name** in the **User admin**.

Note: The camera access rights can be set for regular individual users and Active Directory groups but not for regular user groups or individual Active Directory users.



Note: If a user appears in multiple groups with different Privileges and Camera access rights then Enabled properties are prioritized (e.g., if UserA does not have a certain permission in AD-group1 but does have the permission in AD-group2 then the permission will be enabled for userA).

Hint: In case that the configuration does not work please make sure that the configuration options are correct. For example no leading or trailing space must be included in the configuration (e.g. "DC=netavis,DC=net " with a trailing space does not work if the directory address is netavis.net).

14 Working with Layout Navigation

Observer offers powerful layout navigation features that allow you to navigate based on layouts, floor plans, and also other images. This chapter describes how to configure and use Layout Navigation.

Note: Since Layout Navigation is licensed separately of Observer you need a valid license in order to work with these features. See also *11.1 Server system information and restarting* on page 107 for details about what license you have.

Note: Layout Navigation only works on Microsoft Windows. See *2.1 Introduction to Observer clients* on page 11 for details on the functionality available on various platforms.

14.1 Basic concepts and how it works

The Observer layout navigation tool (LNT) allows you to define a hierarchy of **graphical layouts** that correspond to various aspects of your physical environment (section *14.4.1 Planning your layout hierarchy* on page 130 provides details on how to plan the hierarchy).

Layouts that belong together and other related settings can be grouped together in so called **projects**. Depending on the user rights, several users can access and share the same projects and by thus layouts and settings.

On each layout you can place **camera control icons** that correspond to cameras on an Observer server. The camera icons on layouts are interactive, i.e. trigger certain actions when you move the mouse over them or click on them. Such actions can be to show camera live image streams or its recording archive in the corresponding Observer client running on the same client workstation.

On layouts you can also define polygon-shaped **zones** that group certain cameras together and that allow for smart ways of highlighting on events and for good synchronization with the Observer client.

Additionally, you can also display and acknowledge Observer **events** in the tool.

All information used by the LNT (e.g. project and layout definitions, background images, and camera mappings) are stored on the Observer server. Users can use the same LNT information as long as they load the same LNT project, regardless on which client they work.

In a typical installation you would run the Observer client on one screen and the layout navigation tool on another screen (see *2.3 Client multi-window and multi-screen operation* on page 17 for details). However, you can of course run both tools on the same screen as well.

Please note: Currently LNT can only display MJPEG camera streams (MPEG camera streams are not yet supported).

14.2 Installing Layout Navigation

Layout Navigation is available in a locally installed client (see *2.2 Working with the installed Observer client* on page 12) or alternatively via a desktop web browser (see *2.1 Introduction to Observer clients* on page 11).

Note: Layout Navigation only works on Microsoft Windows and requires Windows .NET 2.0 or later.

14.3 Starting Layout Navigation

Layout Navigation can be started in three different ways:

- in the locally installed client (please refer to 2.2.2 *Starting the installed Observer client* on page 12 for more details)
- in a desktop web browser (with the **Start the Layout Navigation Tool (from the browser using Web Start)** option on the start page of Observer)
- in a desktop web browser with a One-Click Single-Sign-On simultaneously with the Observer client (with the **Start the NETAVIS client and the Layout Navigation Tool (from the browser using Web Start)** option on the start page of Observer). When using this option entering wrong **Login credentials** will result in two separate error messages.

Hint: The size and position of the Layout Navigation window is saved and restored upon the next start of the application.

The Layout Navigation main window looks like this:

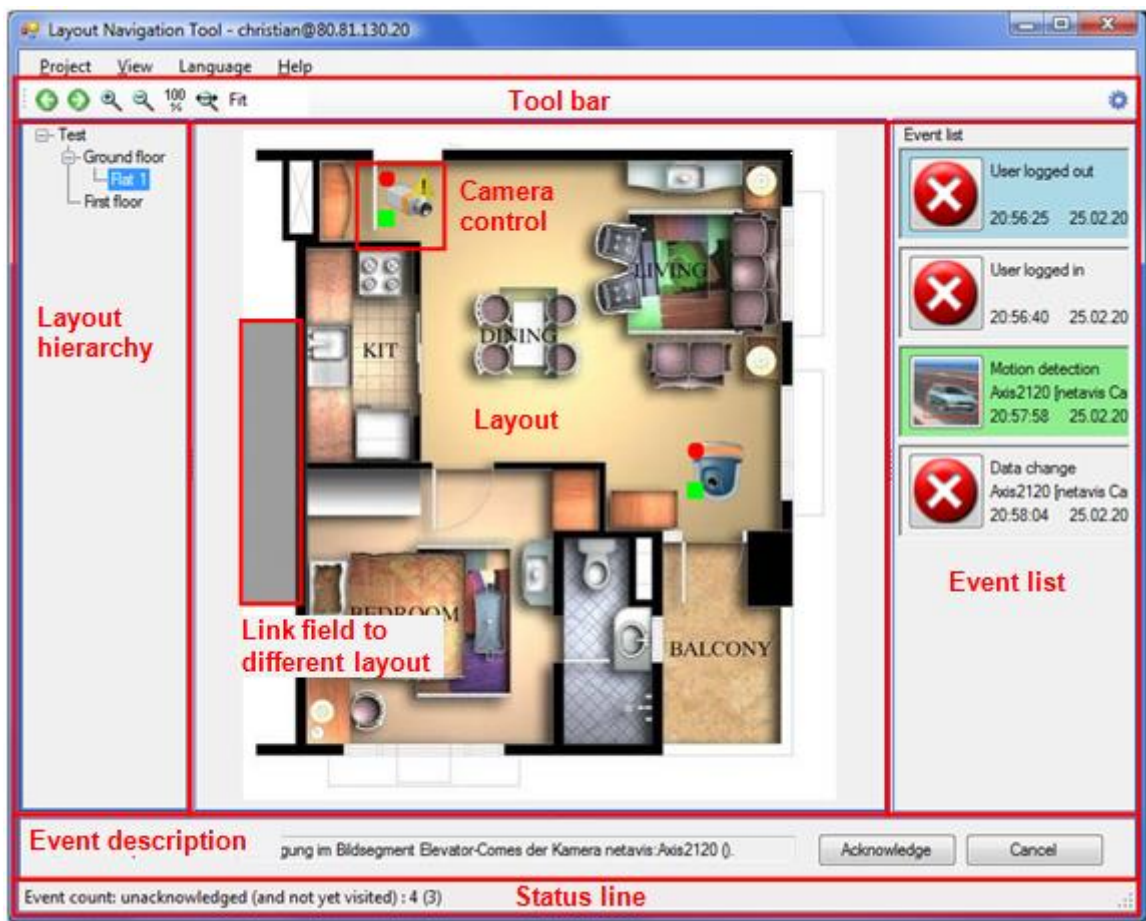

14.4 Setting up a project and defining layouts (Editing mode)

In order to setup LNT for work you have to execute a few steps:

- Plan your layout hierarchy
- Select and upload images to be used for layout backgrounds

- Define the hierarchy and map your cameras

In the next subsections we will cover the above topics.

14.4.1 Planning your layout hierarchy

Before you create a project and start to upload graphics images for your layouts it makes sense to plan the layout hierarchy. For example, if your Observer system covers a building then you could have an overview layout image for the building and then separate subordinate layout images for each floor.

For an even bigger setup: If your Observer system covers a whole area with several office or plant buildings then you could have an overview layout image for the whole area and subordinate layout images for each of the buildings and additional images for the parking lots, driveways, fence sectors, etc. Each of the building layouts then in turn could have subordinate layout images for parts of the building like each of the floors. Each of the floors could additionally have subordinate layouts for parts of the floor or even for each of the rooms. Thus you can create hierarchies at arbitrary levels of detail.

14.4.2 Switching to editing mode and creating a project

1. Switch to editing mode by choosing **Project > Switch to editing mode** or by pushing the editing button  at the right side of the tool bar.
In editing mode the LNT window now has added a new control icon list.
2. Create a new project by choosing **Project > New project** and then enter a name of the new project in the newly opened dialog. Push **OK**. Now you start to upload background images for your layouts.

14.4.3 Creating layouts and mapping cameras, I/O contacts, and zones

After you planned your layout hierarchy you have to select appropriate images for the various layouts. The layout navigation tool supports popular image graphics file formats like GIF, JPEG, PNG, etc.

Depending on your needs and the available screen resolution for the layout navigation you have to choose the size (in pixels) for your images. Please keep in mind that the LNT also supports image scaling to fit the available space.

Please note: Each image's file size is limited to 2MB. For performance reasons it is recommended to use JPEG and PNG files and keep their sizes small.

Creating a new layout

To create a new layout, follow these steps:

1. In the layout navigation tool (LNT) switch to customizing mode by choosing **Project > Switch to editing mode** or by pushing the editing mode button  at the right side of the tool bar.
2. In the **Layout** menu choose **New...**, which opens the **Layout** dialog:

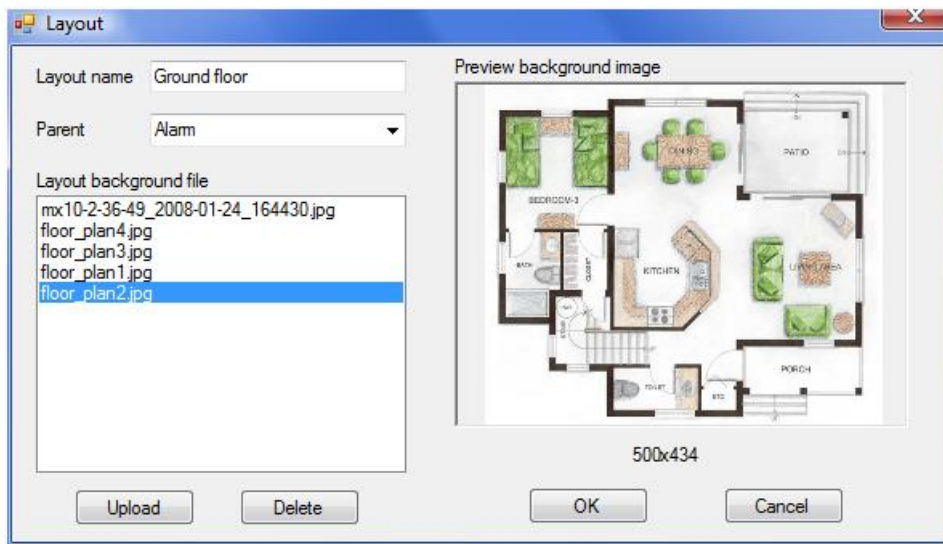

3. Enter a name for the layout.
4. Select a background image from the list of available uploaded images or push **Upload** to upload a new background image for the layout (you can also delete uploaded images from the server by selecting an image from the list and pushing **Delete**).
5. If the layout is subordinate to another layout then choose the parent layout from the **Parent** pop-up menu (you can change the layout hierarchy later on via the **Layout > Properties** dialog).
6. Push **OK** to create the layout.
Now you see that the layout with the selected background image has been created.

Mapping cameras

1. From the list of controls at the right side drag a camera control icon with the mouse onto the layout and drop it there. A camera selection dialog opens automatically. Choose the I/O device and contact and push **OK**. Now you have mapped the camera to your camera icon.

Repeat the above step for other cameras.

You can delete a camera by selecting it with the mouse by choosing **Delete** from the right mouse button pop-up menu.

Mapping I/O contacts

LNT allows you to work with I/O devices, i.e. you can display the state of input contacts and you can switch output contacts of I/O devices (for configuring I/O devices, please refer to *23.7 Configuring I/O devices* on page 199). You can place such I/O controls onto layouts like camera controls.

Here are some icons representing the various states of input and output contacts:

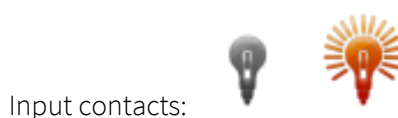



Impulse button:

1. From the list of controls at the right side drag an I/O control icon with the mouse onto the layout and drop it there. An I/O contact selection dialog opens automatically. In the list you only see I/O devices that are configured with Observer. Choose the device and the I/O contact and press **OK** (depending on whether the I/O control represents an input, an output or an impulse button, you get only input or output contacts of the selected device). Now you have mapped the I/O device to the icon.

Repeat the above step for other I/O contacts.

You can delete an I/O contact control by selecting it with the mouse by choosing **Delete** from the right mouse button pop-up menu.

Defining zones

LNT allows you to group several cameras on a layout into so called zones that can have arbitrary polygon shapes.

Cameras belong to a zone as long as they are positioned inside the boundaries of the zone. You can place an arbitrary number of zones onto a layout.

Here is how you can create a zone:

1. Select a layout from the layout hierarchy.
2. Drag the **Zone field** with the mouse from the controls list at the right side and drop it onto your layout. Where you drop the zone field control with the mouse will be the first corner of the polygon shape and you can now define the zone shape by clicking at further corners. To finish the zone definition, close the polygon shape. Alternatively you can create a rectangular zone by pressing the **CTRL** key while moving the mouse.
3. Per default the zones will be named “Zone-1”, “Zone-2” and so on. You can rename and delete a zone via the right mouse button pop-up menu. Zones can be moved by dragging them with the mouse.

Please note: A zone can trigger certain actions, e.g. when you click with the mouse on it, a zone can show all cameras belonging to the zone in the Observer client. This, for example, will either create a new view in the Observer client or map it to an existing view depending on the names of the views and zones. Therefore the name of a zone can be of importance.

Here is how the mapping works for the LNT action **Show zone live in Observer Client:**

If there is an Observer view that has the same name as the LNT zone and that also contains all the cameras of the LNT zone, then this view is exposed in the Observer client. Otherwise a new view is created with the name of the zone. Details for zone actions can be found under *14.5.3 Modifying zone control appearance and behavior* on page 135.

Linking layouts with link fields

LNT offers link fields to easily navigate between layouts. Link fields can be placed on layouts and are resizable grey areas. Clicking on a link field in Navigation mode will open the “linked” layout.

Here is how you can link layouts via link fields:

1. Drag the **Link field** from the controls list at the right side and drop it onto your layout. Where you drop the zone field control with the mouse will be the first corner of the polygon shape and you can now define its shape by clicking at further corners. To finish the link field definition, close the polygon shape. Alternatively you can create a rectangular link field by pressing the **CTRL** key while moving the mouse.
After you finished defining the shape of the link field, a dialog is opened offering the available layouts for this link field. Choose a layout by double clicking or by pushing the **Select** button. This defines which layout is to be opened when the link field double clicked in Navigation mode.
2. Choose **Save** from the **Project** menu to save your changes.

Now you can repeat the steps above to create your overall layout hierarchy. You can switch back to Navigation mode by clicking the navigation mode icon  at the right side of the tool bar.

Defining a default project

To define a default project to be loaded when LNT is started, follow these steps:

1. In the **Project** menu choose **Set default project...** which opens a dialog listing all available projects. Choose a project and push **Select**. To not load a default project, choose **<No default project>** from the list.

Now this project will be loaded automatically at startup.

Defining a home layout

A home layout can be defined which is automatically shown when the project is loaded. You can set the home layout by following these steps:

1. In the layout hierarchy select the layout that you want to set as home layout.
2. In the **Layout** menu choose **Set as home**.

Now this layout will be opened automatically when the project is loaded.

14.5 Customizing the behavior and appearance of controls

LNT currently has 2 types of controls that can be modified: camera controls and zone controls (the link field control cannot be modified).

LNT lets you modify several aspects of the appearance and behavior of these control icons:

- Icon image and appearance.
- What happens when you move the mouse over a control icon or when you click on it.
- What happens on certain events originated by Observer related to cameras or zones.

Also you can create new control icons with your own icon images.

14.5.1 Modifying camera control appearance and behavior

1. Switch to editing mode by choosing **Project > Switch to editing mode** or by pushing the editing button  at the right side of the tool bar.
2. In the control icon list click on a camera icon with the right mouse button and choose **Modify...** from the pop-up menu. This opens the **Modify control** dialog:

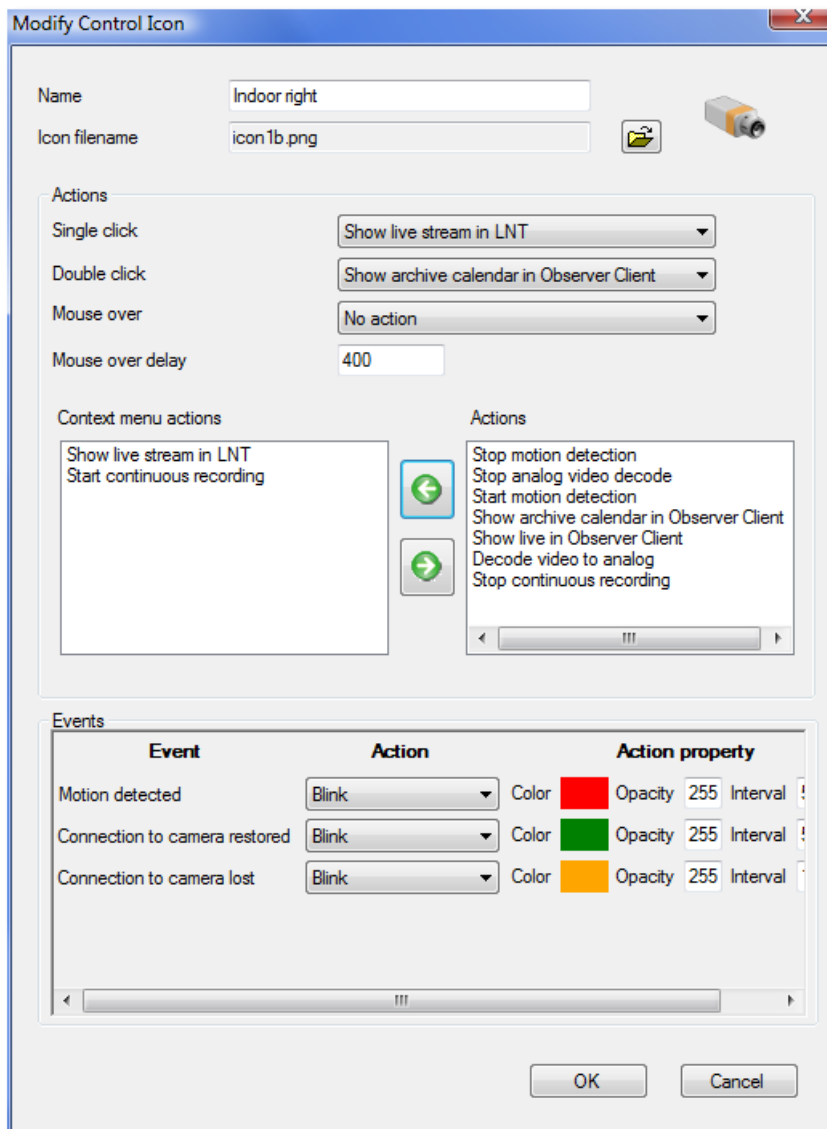

In this dialog you can define the control name and image and which actions are to be performed on certain mouse operations and events.

Actions

The possible **Actions** are:

- **Show live in Observer Client** exposes a large live view of the respective camera in the Observer client that runs on the same machine. If no client is running on the same machine, then nothing is happening.
- **Show archive calendar in Observer Client** exposes the archive calendar view of the respective camera in the Observer client that runs on the same machine. If no client is running on the same machine, then nothing is happening.
- **Show live stream in LNT** opens a window showing a live stream of respective camera in LNT. If this action is bound to **Mouse over** then the window will be automatically closed when the mouse is moved away from the camera icon. If this action is bound to **Single click** or **Double click**, then the window stays until it is closed manually. To close all such windows, you can select **Close all live streams** in the **View** menu.

- **Start/Stop continuous recording** starts or stops continuous recording of the camera in Observer. It actually sets or deletes the **Enable interval** checkbox in the camera admin's **Scheduling** dialog. Please be aware that there must be at least one continuous recording interval for the camera for this to work (refer to *7.1.1 Scheduling continuous recordings* on page 72 for details).
- **Start/Stop motion detection** enables or disables motion detection of the camera in Observer. It actually marks or unmarks the **Enabled** checkbox in the camera admin's Motion detection dialog. Please be aware that there must be at least one detection field definition for the camera for this to work (refer to *8.1.2 Basic configuration of server-based motion detection* on page 86 for details).
- **Start/Stop analog video decode** allows the control of special devices that decode IP-based network video signals to analog video signals. This is useful for example for security center video walls that are driven by analog video signals. The configuration of these special devices must be done in configuration files (please refer to the Release Notes or to the customization documentation).

Events

You can also modify the behavior of control icons for certain events, like **Connection to camera lost** or **Motion detected**.

3. Click **OK** to save changes.

14.5.2 Adding a new camera control

1. Switch to customizing mode by choosing **Project > Switch to editing mode** or by pushing the customize button  at the right side of the tool bar.
2. In the control icon list click the right mouse button and choose **Add control...** from the pop-up menu. This opens the **Add new control icon** dialog which is essentially the same as the **Modify control icon** dialog (see *14.5.1 Modifying camera control appearance and behavior* on page 133).

Here you can define the icon name and image and which actions are to be performed on certain mouse operations.

You can also modify the behavior for certain events, like color and blinking.

3. Click **OK** to create the new camera control icon.

14.5.3 Modifying zone control appearance and behavior

1. Switch to editing mode by choosing **Project > Switch to editing mode** or by pushing the editing button  at the right side of the tool bar.
2. In the control icon list click on a zone icon with the right mouse button and choose **Modify...** from the pop-up menu. This opens the **Modify Zone** dialog:

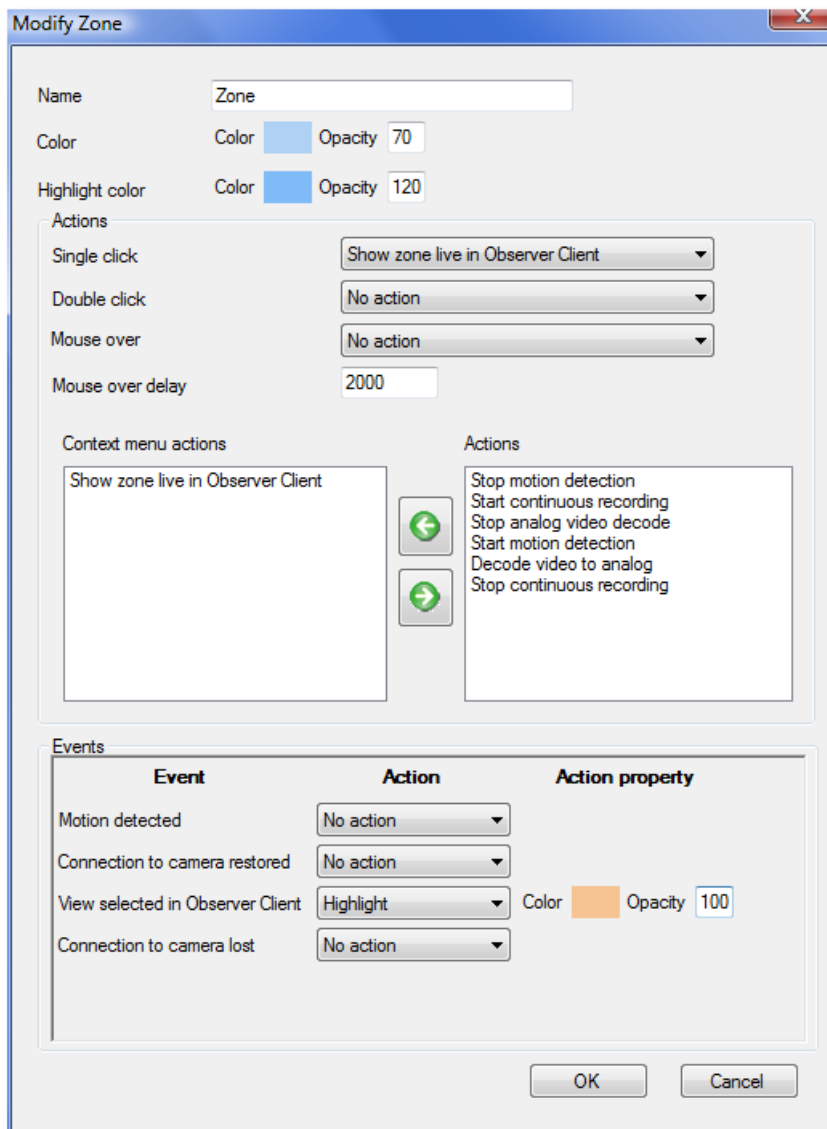

In this dialog you can define the color of the zone and which actions are to be performed on certain mouse operations and events.

Actions

The possible **Actions** are basically the same as for the camera control (see *14.5.1 Modifying camera control appearance and behavior* on page 133) with one addition:

- **Show zone live in Observer Client** exposes the corresponding view of the zone in the Observer client that runs on the same machine. If there is an Observer view that has the same name as the LNT zone and that also contains all the cameras of the zone, then this view is exposed in the Observer client. Otherwise a new view is created with the name of the zone.

Events

You can also modify the behavior of zones of this type for certain events, like **Connection to camera lost** or **Motion detected**.

The event **View selected in Observer Client** works this way: If there is an LNT zone with the same name as the view in Observer then the corresponding action is triggered.

3. Click **OK** to save changes.

14.5.4 Adding a new zone control

1. Switch to customizing mode by choosing **Project > Editing mode** or by pushing the customize button  at the right side of the tool bar.
2. In the control icon list click the right mouse button and choose **Add zone...** from the pop-up menu. This opens the **New zone** dialog which is essentially the same as the **Modify Zone** dialog (see 14.5.3 *Modifying zone control appearance and behavior* on page 135).
3. Click **OK** to create the new zone control.

14.5.5 Modifying I/O contact control appearance and behavior

1. Switch to editing mode by choosing **Project > Switch to editing mode** or by pushing the editing button  at the right side of the tool bar.
2. In the control icon list click on an I/O control icon with the right mouse button and choose **Modify...** from the pop-up menu. This opens the **Modify control** dialog for the corresponding I/O control type:

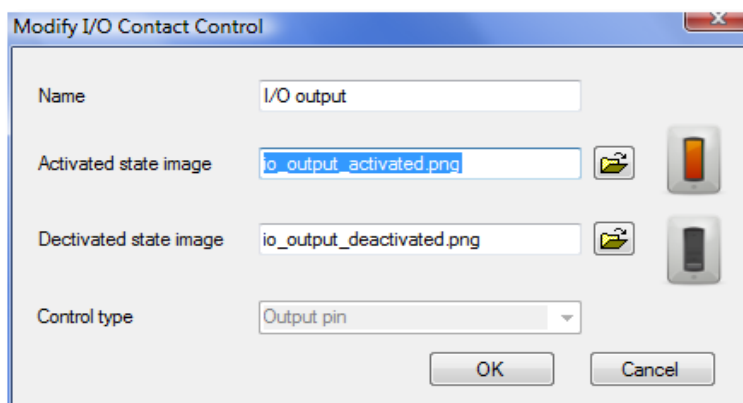

In this dialog you can define the name of the control and the two images for activated and deactivated states. For the Impulse Button you can also set the **Impulse Duration (ms)** and whether 0 or 1 should be set. The control type (Input, Output, Impulse Button) cannot be modified.

3. Click **OK** to save changes.

14.5.6 Adding a new I/O contact control

1. Switch to customizing mode by choosing **Project > Switch to editing mode** or by pushing the customize button  at the right side of the tool bar.
2. In the control icon list click the right mouse button and choose **Add I/O contact...** from the pop-up menu. This opens the **Modify I/O Contact Control** dialog (for a screenshot see 14.5.5 *Modifying I/O contact control appearance and behavior* on page 137).

In this dialog you can define the name of the control and the two images for activated and deactivated states. Also set the **Control type**: An **Input contact** displays the state of the input contact of an I/O device. An **Output contact** allows you to switch an output contact of an I/O

device. An **Impulse button** allows you to manually switch an output contact for a predefined period of time.

For example, for an input contact that shows the state of a gate barrier you can use images that reflect the open and closed state of the barrier.

3. Click **OK** to create the new camera control icon.

14.6 Layout navigation and operation (Navigation mode)

Switch to Navigation mode by clicking the navigation mode icon  at the right side of the tool bar or by choosing **Project > Switch to navigation mode**.

Note: An Observer client must be running under the same user on the same client workstation so that it can be controlled by Layout Navigation.

14.6.1 Peeking live video of mapped cameras

The default behavior of some camera icons is that you can peek at live video of mapped cameras by moving the mouse pointer over a camera icon. Then the live video stream will be shown on top of the layout:



As soon as you move the mouse pointer away from the icon, the stream disappears. This behavior can be changed with the **Modify control icon** dialog (see 14.5.1 *Modifying camera control appearance and behavior* on page 133).

14.6.2 Showing a camera in the Observer client

When you **single click** a camera icon in LNT then the corresponding camera will be shown in full size in the Observer client. This behavior can be changed with the **Modify control icon** dialog (see 14.5.1 *Modifying camera control appearance and behavior* on page 133).

Alternatively a camera can also be dragged from Layout Navigation and dropped into a specific view port in the Observer client to show its live stream there.

Note: An Observer client has to be running on the same machine being connected to the same server in order for the feature to work (the client will not be started automatically by LNT).

14.6.3 Positioning to the camera recording archive in the Observer client

When you **double click** a camera icon in LNT then recording archive of the corresponding camera will be shown in the Observer client running on the same machine. This behavior can be changed with the **Modify control icon** dialog (see *14.5.1 Modifying camera control appearance and behavior* on page 133).

Note: An Observer client has to be running on the same machine being connected to the same server in order for the feature to work (the client will not be started automatically by LNT).

14.6.4 Navigating in the layout hierarchy

You can position to a layout by clicking its name in the layout hierarchy.

You can also jump to a connected layout by clicking a link field.

14.6.5 Working with events in the layout navigation tool

The layout navigation tool (LNT) also allows you to view and acknowledge Observer events.

Please note: Event handling will only work if the user has the rights to work with events.

When a new event occurs in Observer, then it is displayed in the **Event list** at the right side of the LNT window (the **Event list** can be switched on and off in editing mode by choosing **View > Event list**).

The Project settings define what happens when a new event is coming in (see *14.6.7 Project settings* on page 140): The layout that contains the primary control for related to the event can be exposed automatically and also the control that is related to the event can be highlighted (blinking rectangle).

Additionally a longer description is displayed in the **Event description** field at the bottom of the window (which also can be switched on and off in **Editing** mode by choosing **View > Event description**).

You can acknowledge an event by pushing **Acknowledge** in the Event description field. Acknowledged events will be removed from the Event list. Pressing **Cancel** sets the state of the event to seen (visited) but does not acknowledge it.

Please note that for each camera, a primary control can be defined that is exposed when a new event is generated. You can set the primary flag for a camera icon by right-clicking on the icon in editing mode and choosing **Primary** from the pop-up menu.

Generally, events in LNT can have the following states (indicated by different colors of the event entry):

- New (unseen) events are shown as grey (if it is selected then it is shown in green).
- Seen (visited) events are shown in blue.
- Acknowledged events are removed from the list.

When there are several new events, then LNT offers you to see (visit) them one by one. The exact behavior of the visiting and how the event state can be set to seen (visited) can be defined in the

Project settings (see 14.6.7 *Project settings* on page 140). You can, for example, mark a new event as seen and jump to the next event by moving the mouse over the blinking control.

14.6.6 Camera status display

LNT allows you to display certain states of cameras in the mapped camera and zone control icons. Examples for states that can be displayed are recording, motion detection active, broken connections, etc.

An example of a status display is:



This camera currently is recording and has motion detection enabled.

To modify the status display settings, follow these steps:

1. Switch to editing mode by choosing **Project > Switch to editing mode** or by pushing the customize button  at the right side of the tool bar.
2. Choose **Project > Camera status display settings...** which opens the **Status display settings** dialog.
This dialog now allows you to define the status settings for camera and zone controls. You can modify the status display settings according to your needs. You can also enable/disable certain status displays by setting the **Enabled** flag.
3. Push **OK** to save your changes or **Cancel** to discard them.

When you switch to navigation mode, the new settings become effective.

14.6.7 Project settings

The layout navigation tool (LNT) allows you to set several project settings that define the workings of the tool. In the **Project** menu choose **Project settings...** to open the **Project settings** dialog.

Here you can set the following values:

Setting	Description
Show home layout on load	Defines whether the Home layout is shown when the tool is started. In order for that to work you must have a home layout defined.
Highlight zone under mouse cursor	Defines whether zones will be highlighted when you move the mouse over them. This can be useful for distinguishing when the mouse cursor is over the zone or over the camera control icon on top of the zone.
Automatically jump to layout on event	In case of an event this setting defines whether the layout that contains the primary control related to the event should be exposed.

Setting	Description
Visiting order of events	Defines in which order new events are to be visited.
Set event state to seen (visited) by	When a new event comes in or an existing event is selected, the related control blinks or is highlighted. This setting defines with what mouse operation the state of the event can be set to seen (visited) (blinking is stopped).
Only suggest events of mapped images for visiting	If this checkbox is marked then only events of mapped cameras will be suggested for automatic visiting. If it is unchecked then all events will be suggested.
Standard view size for layouts	Defines the default image size, either Fit image or Full size .
Event list insertion mode	Defines whether new events in the Event list are inserted from the Top or from the Bottom .

15 Video analytics with iCat

iCat is the video analytics toolkit of Observer. It provides powerful and easy-to-configure object detection and tracking mechanisms as well as a statistics module with integration to the event management system EMS.

iCat can also interface to 3rd-party video analysis toolkits and algorithms (contact Netavis Software GmbH).

Please note: Since iCat and some functions are licensed separately of Observer you need a valid license in order to work with these features. See also *11.1 Server system information and restarting* on page 107 for details about what license you have.

15.1 iCat highlights

- iCat **works with any camera** that can deliver an MJPEG, MxPEG, MPEG-4, H.264 or H.265 stream (this covers also analog cameras that are connected via a video server).
- iCat is **easy to configure** and setup and it **works in difficult situations** also with extreme camera perspectives.
- It offers **flexible scheduling** of iCat definitions depending on date and time. Thus you can have different setups for weekdays and weekend as well as day and night.
- All iCat video analytics modules can provide the resulting video analytics data while **optional privacy masks** cover the video streams. Additionally it is possible to run iCat video analytics **without storing any associated recordings**. As such only the iCat video analytics data output is stored and no video streams are available, neither live in the Online Monitor nor as recordings in the Archive Player. This is particularly useful for installations in the retail sector (e.g. for obtaining the customer frequency and customer segmentation via iCat video analytics).
- The **iCat Number Plate Recognition** module detects number plates for use in vehicle entry, parking, and free flow scenarios.



- The **iCat Traffic** module enables applications for roads and highways: Traffic Monitoring, Stopped Vehicle Detection, Wrong Way Detection.



- The **Face Detection** module automatically detects human faces in video streams and estimates the person's age group and gender.



- The **Smart Tripwire** function for **people and object counting** prevents wrong and double counting and works even with the most difficult entrance situations.



- The Smart Tripwire also allows **detecting wrong direction** movements of people and objects.
- **Powerful and robust object tracking** and **event triggering** can be constraint to **object sizes, speeds**, and other properties.



- **Heat maps** allow you to view various object statistics in an intuitive way.

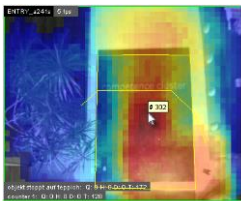

- Event statistics can be manually **exported to Excel** or automatically into .csv files for further processing.
- All iCat detection annotations are **available for live streams and in archived recordings**.
- **Seamless integration** with the Observer event management system EMS and other Observer functions. Additionally iCat offers **camera sabotage detection** and **lighting change detection**.
- iCat algorithms have been tuned for the **highest performance** and **least burden on the server**.

15.2 Basic iCat concepts

iCat basically consists of the following components that are tightly integrated with Observer:

1. An object detection and tracking engine analyzes the video stream and tracks detected objects. Please be aware that an object has to show consistent motion first in order to be detected and tracked.

2. An event logic engine with configurable event triggers decides when a tracked object triggers an event.
3. A real-time statistics module stores statistical information about various aspects of objects like object sizes and speeds.

For setting up a camera with most iCat video analytics features you essentially configure the following things:

Object tracking region: The object tracking region defines the part of the camera view in which iCat is detecting and tracking objects. For each camera you can define one tracking region that is either the full camera view or a part of it in the form of a polygon or rectangle. No object will be detected or tracked outside of this tracking region. Since the CPU overhead caused by iCat is directly proportional to the size (area) of all the active tracking regions of all active cameras of a server, optimizing the tracking regions will save CPU power. Region definitions can also be used to mask out problematic areas in the scene as well (e.g. swaying trees).

For each tracking region you can also define what object statistics should be measured by iCat. Such statistics can then be visualized.

Event triggers: Each camera can have several event triggers that define under what conditions an event is generated by the detected objects. Event triggers only work inside of the object tracking region. Examples of event triggers are people or object counters and detectors of stopped or started objects. The CPU load caused by event triggers compared to the tracking region is negligible.

Scheduling: The standard Observer scheduling mechanisms are also used for scheduling (activating) various iCat setups. For example, it is possible to have different iCat settings for weekdays and weekends.

15.2.1 Considerations for setting up a system with iCat

Camera selection and placement

Though iCat is able to analyze video captured by any type of supported camera, using a device with higher image quality will result in better detection and tracking. The iCat video analytics features work with in- and outdoor cameras as well as for different perspectives. The configuration of these features in Netavis Observer is pretty simple, as you will see below.

For people and object counting, the best results are possible if the camera is mounted overhead downward looking.

Please note: Setting up iCat definitions for PTZ cameras is problematic since most of the iCat functions require a fixed camera position.

Video streams, codecs, and multi-streaming

iCat video analytics works with any supported camera (including analog cameras that are connected via a video server or encoder). If the camera has been configured with stream profile with an MJPEG stream, iCat uses this format because it is the most efficient for video analytics. If the camera provides only MPEG formats (MPEG-4, H.264, H.265, and MxPEG) then iCat can also work on these streaming formats. However, please be aware that video analytics on MPEG streams requires a lot more CPU power than on MJPEG streams since the decoding is much more complex (for multi-stream operation please see below). Also video analytics in MPEG streams causes additional delays because it works on groups of pictures or frames (so called GOPs). As a rule of thumb, iCat adds a delay of approximately 1

GOP duration. Depending on the actual MPEG cameras model, a GOP duration is between 0.5 and 1 sec (see also *4.2 Adding a new camera and basic configuration* on page 31).

Per default iCat automatically selects the best available video stream profile depending on the specific iCat type whereby the following minimum requirements are considered:

- Motion detection: minimum QVGA resolution (320x240 pixels)
- iCat video analytics (with object tracking region, e.g., people counting and heat maps): minimum VGA resolution (640x480 pixels) with at least 15fps
- iCat Face Detection: minimum 720P resolution (1280x720 pixels) with at least 15fps
- iCat NPR: minimum 720P resolution (1280x720 pixels) with at least 15fps

The video stream profile selected for iCat on each camera is shown in its Video Analysis (iCat) tab. Additionally, it is possible to manually select which stream should be used by iCat video analytics via the **Stream used for iCat** configuration option available in the Video Analysis (iCat) admin.

Please note: The **Stream used for iCat** information only refreshed upon the initial selection of a camera. Subsequent changes only become visible after selecting a different camera and then switching back to the original one.

Hint: When using multi-streaming it is strongly recommended to use video streams with identical aspect ratios. This is particularly important when using a (dynamic) privacy mask since differing aspect ratios can lead to areas which should be covered becoming visible!

CPU load of iCat (performance issues)

iCat runs on the server and works very efficiently. The CPU overhead caused by iCat is directly proportional to the following aspects (see also *15.2 Basic iCat concepts* on page 143):

- The size (area) of all the active tracking regions of all cameras of a server. This means that optimizing the tracking regions will save CPU power. The number and shape of event triggers is negligible.
- The video processing speed (in fps) of iCat.
- The streaming format (see above).

An Observer server running with iCat on standard (not high-end) server hardware can easily handle approximately 10 iCat-enabled cameras with standard settings. Additional CPU power (e.g., additional cores), enhanced RAM speed, and bigger L2 caches help to boost the iCat performance.

Object detection

Depending on the sensitivity and other settings iCat currently detects objects of 8x8 pixels or bigger in size (in a VGA image). Only moving objects are detected. New objects are detected by iCat after a few video frames. How quickly objects are detected is also influenced by the sensitivity setting.

iCat video processing speed

If the objects you want to track move very quickly across your camera view you will require a higher video processing speed of iCat than if they move slowly across your camera view. As a rule of thumb the optimal frame rate for object detection and tracking is 15 fps.

Note: Not the absolute speed of the objects influences what processing speed you need but the relative speed that these objects have in your camera view. This relative speed is influenced by the camera perspective and distance from objects. Example: Cars on a highway are moving very fast. However if you look at them with a camera from a larger distance and from a perspective with a flat angle the cars are actually are moving pretty slowly in your camera's view. Therefore you can choose a slower video processing speed even for such fast objects like cars on a highway.

15.3 Setting up a camera for video analytics with iCat

15.3.1 Working with iCat definitions

Several options for working with iCat definitions are available in the right-click mouse menu:

- **Add new definition:** Opens the dialog for adding a new iCat definition.
- **Delete selected definition:** Deletes the iCat definition.
- **Modify selected definition:** Allows the modification of the iCat definition.
- **Duplicate definition:** Creates a copy of the selected iCat definition on the same camera.
- **Deny modification of selected definition:** Makes an iCat definition read-only so other users cannot modify or delete it. The names of read-only definitions are displayed in italics.
- **Reset traffic direction learning:** Only applicable for Wrong Way Driver definitions. See *15.3.13 Defining Wrong Way Detection* on page 160 for more information.
- **Reset all heat map values on this host:** Resets the heat map values of all cameras on this server.

15.3.2 iCat event settings

Event properties can be configured for each iCat definition:

1. You can enter an optional **Comment** which is shown in the event details.

Hint: You can also use the **Comment** field to configure certain views to be shown to one or multiple users when an iCat event occurs. See *6.10 Dynamic View Control in Online Monitor* on page 64 for more information.

2. You can choose a specific **Icon**, **Sound**, and **Highlight color** for the event when it is shown in the **Event list**.
3. You can also define a special event priority for events generated by the iCat definition by setting the value **Priority of generated event**. Please note that the event priority is a relative priority whereby 100 is the default priority (see also *9 Handling events* on page 92).
4. For more information on the **Dynamic view action** configuration please see *6.10 Dynamic View Control in Online Monitor* on page 64
5. The check boxes **Save event in event list** and **Do not save event in event list** allow you to selectively override the general setting for the camera schedule which is defined in *15.3.16 Scheduling iCat video analytics and recordings* on page 164).

15.3.3 Defining an object tracking region

1. Choose **Video analysis (iCat)** from the **System administration** menu. This opens the **Video analysis (iCat)** dialog.
2. Select a camera in the camera tree and in the menu select **Add new definition**.
3. In the **Type** pop-up menu choose **Object tracking region**.
4. In the **Identifier** text field enter a name for this region.
5. Choose whether you want a **Polygon** or **Rectangle** shape by checking the respective check box.
6. Now you can draw the region with the mouse in the preview pane. For a polygon you just click with the mouse to define the corners of the polygon. You close the polygon by crossing an existing edge or by double clicking with the mouse. Here is an example of a tracking region:



Please note: As indicated in *15.2 Basic iCat concepts* on page 143 and *15.2.1 Considerations for setting up a system with iCat* on page 144 objects will only be detected and tracked inside a tracking region. Event triggers will only work inside the boundaries of tracking regions. On the other hand, making the object tracking region as small as possible helps you to save CPU power of your Observer server. Also be aware that the tracking region should approximately at least be twice the size of the biggest objects you want to track.

7. Now you have to set the configuration parameters of the tracking region:

Field label	Description
Indoor camera	Enable this setting if the camera is an indoor camera. Indoor setting usually is best for rooms not bigger than 10x10m and objects not farther away than 15m. Disable this check box for outdoor environments. Experiment with this setting, if the detection/tracking quality is not ideal.
Overhead downward looking	This setting only takes effect if Indoor camera is enabled. Enable the setting if the camera is overhead mounted and downward looking. This will improve object separation and the accuracy of object counting. In our example above, the camera is an indoor camera and mounted overhead downward looking.

Field label	Description
Sensitivity	<p>Usually this setting should be left at Normal. Only if you are not satisfied with the object detection quality or behavior you can try to modify this setting.</p> <p>If you want a sharper object detection and separation, you can set the Sensitivity to High or Very high. Also for example, if you want to detect very small objects, you can improve the sensitivity. The Sensitivity also influences how fast new objects are detected. Higher Sensibility means quicker object detection, lower means slower detection.</p> <p>For environments that are very noisy visually and that cause too many objects to be detected, the Sensitivity can be set to Low or Very low.</p>
Max object lifetime (sec)	<p>Defines how long a detected object is tracked before it is dismissed by iCat (i.e. no longer treated as object but essentially becoming background). After an object is being dismissed by iCat, if it starts moving again, it will be detected as new object. The setting is useful to lower the probability of falsely tracked objects which remain in the scene for too long. If you experience that objects are no longer tracked though they are visible and moving, this value might have to be increased.</p>
Max stopped object lifetime (sec)	<p>Defines how long a detected object that stopped is tracked before it is dismissed by iCat (i.e. no longer treated as object but essentially becoming background). After an object is being dismissed by iCat, if it starts moving again, it will be detected as new object.</p> <p>The setting is useful for removing false detections (usually caused by environmental changes) which often remain still for a longer period. If objects in the scene usually stop longer than this time limit, then set it higher.</p>
Video processing (fps)	<p>This defines at what frame rate the iCat algorithms operate. If the objects you want to track move very quickly across your camera view you want to improve the speed. If they move slowly across the camera view you can decrease the speed. See also <i>15.2.1 Considerations for setting up a system with iCat</i> on page 144.</p>
Tolerance radius for stopped object (%)	<p>Defines when how much a stopped object may move away from its stopping position before iCat detects it to move again.</p> <p>There is a virtual circle centered at the object's center point. In this field one can define its radius proportional to the size of the object. If the object's center remains inside the circle it is detected as stopped. When this value is set close to 100%, slowly moving or loitering objects will be detected as stopped. It also influences the statistics of stopped objects.</p>

Field label	Description
Reinitialize on light change	Defines whether the iCat object tracking region will be re-initialized if there are significant light changes (e.g. a flashlight that is turned on in a dark environment).
Slow adaptation	This option lengthens the learning period to distinguish between the static background and moving objects. It can be useful for particularly crowded scenes in people counting applications.

8. Press **Next** to get to the **Heat map data collection** heat map settings for the object tracking region. Here you can define what heat map data iCat should collect. Later on the resulting heat maps can be shown in the **Online monitor** and **Archive player** (see *15.4.2 Displaying heat maps* on page 166). Currently, the following data can be collected:

- Count statistics
- Speed statistics
- Stopped object count statistics
- Object stopping time statistics
- Size statistics
- Object count
- Object speed
- Stopped object count
- Object stopping time

Netavis Observer 4.6 introduced two new features for heat maps:

- a. Normalizing the heat maps of all cameras (see *11.2 Setting Observer server parameters* on page 109)
 - b. Resetting the heat maps (applied to all cameras on this server!):
 - Manually: Select the corresponding Object Tracking Region definition, right-click on it, and select **Reset all heat map values on this host**.
 - Automatically: Configure the **Heatmap statistics reset method** option in the Host Admin (see *11.2 Setting Observer server parameters* on page 109)
9. Press **Save** to create the tracking region. Later on you can modify the tracking region settings.
10. If you did not yet define the scheduling for iCat activities, then after you save the first iCat definition for a camera, you will be prompted for whether you want to edit the scheduling now.

Click on the **Yes** button if you want to configure the scheduling now (refer to section *15.3.16 Scheduling iCat video analytics and recordings* on page 164 for further information).

Click on the **No** button if you do not wish to schedule the recording or if you want to do that later.

Please note:

- If you add a new iCat definition, it will automatically be assigned to all iCat schedules of the camera. If you do not want that, you have to remove the assignment manually (see *15.3.16 Scheduling iCat video analytics and recordings* on page 164).
- If a definition is not assigned to a schedule then it will not be activated and no archive recordings will be made and no events will be generated.

15.3.4 Defining an event trigger for people and object counting (Smart Tripwire)

Once you have created a tracking region, you can create an arbitrary number of event triggers inside this tracking region. Event triggers define under what conditions an Observer event is generated by iCat. Such events can trigger automatic recording and are stored in the normal Observer event database that can be queried and exported.

Currently iCat supports the following event triggers:

- A Smart Tripwire for directional people or object counting. This tripwire is directional, so if you want to count objects in two directions you would create two tripwires.
- A polygon or rectangle that creates an event when an object either crosses the field, stops inside the field or starts moving inside the field (e.g. for perimeter protection).

Please note: Before you can define an object trigger you must first define an object tracking region (see *15.3.3 Defining an object tracking region* on page 147).

Here are the steps for creating a counting tripwire:

1. Choose **Video analysis (iCat)** from the **System administration** menu. This opens the **Video analysis (iCat)** dialog.
2. Select a camera make sure that you have a suitable tracking region defined that allows for object counting.
3. Choose **Add new definition** from the menu.
4. In the **Type** pop-up menu choose **Event trigger**, which will expose the configuration settings.
5. Under the camera preview choose the **Tripwire** check box for directional people or object counting.
6. Now you can draw the tripwire line with the mouse in the preview pane (whereby the previously defined object tracking region is also visible for your reference). You just click with the mouse to define the corners of the polygon. You finish the line by double clicking with the mouse. Here is an example of a tripwire:



This tripwire triggers a counting event whenever an object moves from the green area across the red tripwire. The tripwire is “smart” as it only counts objects that have first been detected in the green area and move across. It would not count the object if it would first be detected in the non-green area, then moved across the line into the green and then move across the tripwire from the green to the non-green area. It also would not double count an object that would have moved across the line twice.

Hints: To count **incoming and outgoing people or objects** you would create two different tripwires with opposite green areas which would both trigger events. You can also use the tripwire to **detect objects moving in the wrong direction**.

Please note: As indicated *15.2.1 Considerations for setting up a system with iCat* on page 144 objects will only be detected after a few frames. Therefore an object can move a bit before it is actually detected as object by iCat. Therefore it makes sense to have the green area big enough to allow iCat time for the object detection. If that is not the case it might be possible that quickly moving objects are not detected before they cross the tripwire and therefore would not be counted. The ideal settings depend on viewed (relative) object speed and iCat video processing frame rate.

Do not place the tripwire too close to areas where objects exit the scene (e.g. image borders, doors), because they might disappear before crossing the tripwire. It is a good practice to draw the tripwire about half the average object size away from such areas.

7. You can also define when an object is counted by either selecting **Object center point**, **Any point of object**, or **Whole object**. The most appropriate choice in most cases is **Object center point** because of its robustness.
8. When you press the **Next** button you can define additional constraints for the event creation. You can limit the counting only to certain object sizes, certain aspect ratios, and a certain speed. Currently those measures are definable in pixels (please keep in mind that the resolution iCat works on is either CIF or QVGA depending on the aspect ratio of the camera). Future releases of iCat will allow for real world measures.

Zero values in these fields mean that there is no constraint.

Hint for constraining the object size or speed: The size is the area of the object in pixels and the speed is also measured in pixels per second. To know what object sizes or speeds you want to filter it is helpful to watch a few objects passing the triggers and switch on the object markers.

These markers show the size and speed of the object in pixels. These are exactly the same measures that you can use for the trigger. Here is an example of an object marker (Object ID is [10], object size is 9110 pixels, speed is 208 pixels/sec):



The section 15.4.1 *Displaying iCat information in the Online Monitor and when playing recordings* on page 165 shows you how to view object markers.

9. In the **Identifier** text field enter a name for this event trigger. An example name for a people counter would be "Entrance 1 incoming".
10. Press **Save** to save your definition.

Please note:

- If you add a new iCat definition, it will automatically be assigned to all iCat schedules of the camera. If you do not want that, you have to remove the assignment manually (see 15.3.16 *Scheduling iCat video analytics and recordings* on page 164).
- If a definition is not assigned to a schedule then it will not be activated and no archive recordings will be made and no events will be generated.

Hint: For more details on using NetavisObserver for people counting please refer to the *People Counting with iCat* White Paper available in the [documentation section](#) of our [website](#).

15.3.5 Defining an event trigger for object starting and stopping

In addition to object counting, iCat also offers to detect starting, crossing, and stopping objects in a defined field.

Here are the steps for creating an event trigger for object starting and stopping:

1. Choose **Video analysis (iCat)** from the **System administration** menu. This opens the **Video analysis (iCat)** dialog.
2. Select a camera and make sure that you have a suitable object tracking region defined that allows for object counting (see 15.3.3 *Defining an object tracking region* on page 147).
3. In the menu select **Add new definition**.
4. In the **Type** pop-up menu choose **Event trigger**, which will expose the configuration settings.
5. Under the camera preview choose the **Rectangle** or **Polygon** check box.
6. Now you can draw the field with the mouse in the preview pane (whereby the previously defined object tracking region is also visible for your reference). For a polygon you just click with the mouse to define the corners of the polygon. You close the polygon by crossing an existing edge or by double clicking with the mouse.
7. Now select on what object behavior you want to trigger an event: When an **Object is crossing field**, when an **Object starts moving in field**, or when an **Object stops in field**. You can also define when an event is triggered by choosing **Object center point**, **Any point of object**, or **Whole object**.

8. In the text field **Minimum time for staying inside field (sec)** (for **Object is crossing field** event triggers) or **Min. time for stopping/staying inside (sec)** (for **Object stops in field** triggers) you can enter a minimum time required for an object that either stops or stays inside a field before an event is triggered.
9. When you press the **Next** button you can define additional constraints for the event trigger. You can limit the counting only to certain object sizes, certain aspect ratios, and a certain speed. Currently those measures are definable in pixels (please keep in mind that the resolution iCat works on is either CIF or QVGA depending on the aspect ratio of the camera). Zero values in these fields mean that there is no constraint.

Hint for constraining the object size or speed: The size is the area of the object in pixels and the speed is also measured in pixels per second. To know what object sizes or speeds you want to filter it is helpful to watch a few objects passing the triggers and switch on the object markers. These markers show the size and speed of the object in pixels. These are exactly the same measures that you can use for the trigger. Here is an example of an object marker (Object ID is [10], object size is 9110 pixels, speed is 208 pixels/sec):

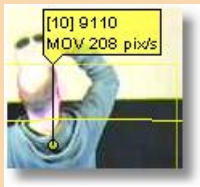

The section *15.4.1 Displaying iCat information in the Online Monitor and when playing recordings* on page 165 shows you how to view object markers.

10. In the **Identifier** text field enter a name for this event trigger.
11. Push **Save** to save your definition.

Please note:

- If you add a new iCat definition, it will automatically be assigned to all iCat schedules of the camera. If you do not want that, you have to remove the assignment manually (see *15.3.16 Scheduling iCat video analytics and recordings* on page 164).
- If a definition is not assigned to a schedule then it will not be activated and no archive recordings will be made and no events will be generated.

15.3.6 Defining sabotage detection

iCat offers intelligent features for detecting three types of camera sabotage actions:

- Camera defocused
- Camera covered
- Camera moved

Please note: For sabotage detection an object tracking region is NOT needed.

When initializing the camera for sabotage detection please make sure that the camera has the correct focus setting and that the scenery and brightness is stable.

Here are the steps for installing iCat-based sabotage detection:

1. Choose **Video analysis (iCat)** from the **System administration** menu. This opens the **Video analysis (iCat)** dialog.
2. Choose a camera and in the menu select **Add new definition**.
3. In the **Type** pop-up menu choose **Sabotage detection**, which will expose the configuration settings.
4. Select any of the three sabotage detection types.
5. In the **Identifier** text field enter a name for this sabotage detection.
6. Push **Save** to save your definition.

Please note:

- If you add a new iCat definition, it will automatically be assigned to all iCat schedules of the camera. If you do not want that, you have to remove the assignment manually (see *15.3.16 Scheduling iCat video analytics and recordings* on page 164).
- If a definition is not assigned to a schedule then it will not be activated and no archive recordings will be made and no events will be generated.

Background information on sabotage detection algorithms

Sabotage detection uses three detector algorithms to generate events for camera moved, defocused and covered.

The camera movement detector tries to locate a couple of strong (= has high contrast) points across the entire picture. Then it searches for them on each of the following frames, while continuously creating new points to keep adapting to a new scenery. A "camera moved" event occurs when a given number of these points are lost for a while.

The focus change detector acts like the auto focus algorithms in digital cameras. It estimates the average sharpness of the picture and produces an event if this sharpness changes abruptly. A "focus lost" event is produced if the sharpness of the picture decreases below a threshold, and a "focus gained" event if the sharpness is increased above a threshold. Both thresholds are based on average sharpness values of previous frames.

The camera covered detector uses a brightness analyzer that calculates the average brightness of the picture for each frame and if something strange happens tries to find out what has happened (light switched off, light switched on or just a person in dark clothes passed by). It does so by analyzing a sample of average brightness values collected in previous frames.

The result of these three detectors are combined to give the final alarm event (camera moved, camera covered, focus lost/gained, brightness change)

Possible reasons of missed or wrong detections

As mentioned above the camera movement detector works with high contrast points on the picture and the focus change detector checks the sharpness of the picture (measuring the sharpness of edges). Logos or date and time text fields generated and placed on the picture by the camera could decrease the accuracy of these detectors or could even prevent detection at all. This is because such overlay fields are always stable, have a high contrast and sharpness and can therefore balance real picture changes, so that the overall change is too small to be detected.

The solution is to disable the text overlay at the camera's own web page.

"Focus lost" and "focus gained" events:

A dynamic scene with moving objects of various sizes always changes the average sharpness a little bit and the detector tries to filter out these small variations. This is not always possible, so one can sometimes experience false "focus lost" or a "focus gained" events.

Covering the camera should cause a "camera covered" event, but the effects of the covering could be very similar (from the algorithm's point of view) to a moved camera or to a lost focus. So the algorithm has to decide what happened and the result is not always the proper event category (one may get "camera moved" and more usually "focus lost" instead of "camera covered"). However, a sabotage event should occur at unusual situations, it is just possible that the detailed category will not match the actual reason.

Hint: As the three sabotage types have many properties in common, to get the best detection rate switch on all sabotage categories. For example, a camera cover event might be categorized as a focus lost, because then image sharpness drops dramatically. If this category is also switched on, the sabotage will surely be detected.

15.3.7 Defining simple motion detection

Prior to release R1.12 Observer offered simple motion detection based on a detection of changed pixels between video frames. Since then this detector has been made more robust and it is now part of iCat toolbox. Simple motion detection does not require an object tracking region.

For more details on setting up and working with this simple motion detection please refer to *8 Working with motion detection* on page 86.

15.3.8 Detecting a lighting change

Please follow these steps to enable lighting change detection:

Please note: For lighting change detection an object tracking region is NOT needed.

1. Choose **Video analysis (iCat)** from the **System administration** menu. This opens the **Video analysis (iCat)** dialog.
2. Choose a camera and in the menu select **Add new definition**.
3. In the **Type** pop-up menu choose **Lighting change detection**, which will expose the configuration settings.
4. Select the checkboxes for **Light switched on** and **Light switched off** to detect abrupt lighting changes like when somebody switches the light on or off.

You can also enter values in the **Brightness high limit (%)** and **Brightness low limit (%)** fields to detect slower lighting changes like during sunrise and sundown. If you leave these values empty, then slower lighting change detection will be disabled.

5. In the **Identifier** text field enter a name for this definition.
6. Push **Save** to save your definition.

Please note:

- If you add a new iCat definition, it will automatically be assigned to all iCat schedules of the camera. If you do not want that, you have to remove the assignment manually (see *15.3.16 Scheduling iCat video analytics and recordings* on page 164).
- If a definition is not assigned to a schedule then it will not be activated and no archive recordings will be made and no events will be generated.

15.3.9 Defining Face Detection

NetavisObserver offers iCat Face Detection. The functionality can be used to detect and count faces in a video stream. Optionally, it is also able to provide age and gender estimations of people and since NetavisObserver 5.0 the attention time and dwell time of faces is also detected.

Here are the steps for configuring Face Detection:

1. Choose **Video analysis (iCat)** from the **System administration** menu. This opens the **Video analysis (iCat)** dialog.
2. Select a camera in the camera tree and in the menu select **Add new definition**.
3. In the **Type** pop-up menu choose **Face detection**, which will expose the configuration settings.
4. In the **Identifier** text field enter a name for this Face detection.
5. Choose whether you want a **Polygon** or **Rectangle** shape by checking the respective check box.
6. Now you can draw the region with the mouse in the preview pane. For a polygon you just click with the mouse to define the corners of the polygon. You close the polygon by crossing an existing edge or by double clicking with the mouse.
7. Check or uncheck the **Age and gender detection** checkbox depending on the requirements.

Note: The default age groups are 0 to 24, 25 to 55, and above 56. These age groups can be customized via the **AgeRangeConfig.SAMPLE.txt** file on the **Netavis Observer Customizer** page. A server restart is required once the custom **AgeRangeConfig.txt** file has been uploaded to the server in order to apply the changes.

8. Check or uncheck the **Display age groups** option to select whether the exact age estimation or the corresponding age group should be shown in the iCat info display. (Only available if **Age and gender detection** is enabled.)
9. The attention time and dwell time feature introduced in Netavis Observer 5.0 added three new options:
 - **Maximum yaw angle (degrees):** Only the time during which a face's angle towards the camera is lower than this threshold is counted as attention time. The time during which the face's angle towards the camera is higher than this threshold is counted as dwell time.
 - **Generate face report after (seconds):** With the addition of the attention and dwell time feature every detected face will result in two events: The event one will be created once a face is recognized (considering the **Minimum detection length** option below). The second event which contains the attention and dwell time will be created once the face is not visible anymore plus the time span configured here has passed.
 - **Minimum detection length (milliseconds):** Defines how long a face has to be visible before a corresponding event is created.

- There is also an option to define a **Minimal face size**. Clicking the button opens a separate window with a snapshot of the camera's videostream and you can draw the minimal face size with the mouse on that snapshot:



Faces which are smaller than this rectangle will not be detected and will not create an event. For increased accuracy you can resize this snapshot window by clicking and dragging on its corners or edges. A previously configured minimal face size can be removed by clicking the **Remove min. face size** button.

Hint: For more details on using NetavisObserver for face detection, including information about how to configure the desired age groups, please refer to the *Face Detection with iCat* White Paper available in the [documentation section](#) of our [website](#).

15.3.10 Defining a Privacy Mask

Privacy masks allow hiding private areas of a camera view from live viewing and recording.

This is an example of a privacy mask hiding the text on the carpet:



Here are the steps for creating a privacy mask:

Please note:

- No object tracking region is needed for a dynamic privacy mask.
- Currently, privacy masks are not shown in Client for Smartphone & Tablet, Layout Navigation, Video4Web, and Video Wall Control.

1. Choose **Video analysis (iCat)** from the **System administration** menu. This opens the **Video analysis (iCat)** dialog.
2. Choose a camera and in the menu select **Add new definition**.
3. In the **Type** pop-up menu choose **Privacy mask**, which will expose the configuration settings.
4. Under the camera preview choose the **Rectangle** or **Polygon** check box.
5. Now you can draw the privacy field with the mouse in the preview pane. For a polygon you just click with the mouse to define the corners of the polygon. You close the polygon by crossing an existing edge or by double clicking with the mouse.
6. In the **Identifier** text field enter a name for this privacy mask.
7. Push **Save** to save your definition.

Please note:

- If you add a new iCat definition, it will automatically be assigned to all iCat schedules of the camera. If you do not want that, you have to remove the assignment manually (see *15.3.16 Scheduling iCat video analytics and recordings* on page 164).
- If a definition is not assigned to a schedule then it will not be activated and no archive recordings will be made and no events will be generated.

15.3.11 Defining Traffic Monitoring

NetavisObserver 4.5 introduced iCat Traffic and with it Traffic Monitoring. It assesses the speed and density of road traffic and can thereby detect traffic jams, low traffic, and other traffic patterns.

Here are the steps for configuring Traffic Monitoring:

1. Choose **Video analysis (iCat)** from the **System administration** menu. This opens the **Video analysis (iCat)** dialog.
2. Select a camera in the camera tree and in the menu select **Add new definition**.
3. In the **Type** pop-up menu choose **Traffic Monitoring** which exposes the configuration settings.
4. In the **Identifier** text field enter a name for the Traffic Monitoring definition.
5. By default the Traffic Monitoring region is assumed to have one lane but you can choose between one, two or three lanes in the **Number of lanes** menu. You can change the position of the region by dragging the green and red dots in the preview pane. The direction of each lane is indicated by the yellow arrow and can be changed by clicking on the area of a lane.



6. Adjust the **Road length** and **Road width** (both in meters) of the road section which is covered by the region configured above.

Please note: The included section should be around 70-100 meter long.

7. Define the **Measurement time unit** (in minutes) which defines how long a certain traffic state has to last before a corresponding event is triggered.
8. Now for each Traffic state except **Normal traffic** the lower and upper thresholds for the **Speed** (in km/h) and **Traffic Density** (in %) have to be defined. Additionally a **Highlight color**, **Icon**, **Sound**, and **Dynamic View Action** can be defined for each Traffic state.

Please note: The **Speed** and **Density** ranges from the different traffic states should not overlap.

15.3.12 Defining Stopped Vehicle Detection

NetavisObserver 4.5 introduced iCat Traffic and with it Stopped Vehicle Detection. It detects vehicles which stop on a road or special segments such as an emergency lane or an exit lane.

Here are the steps for configuring Stopped Vehicle Detection:

1. Choose **Video analysis (iCat)** from the **System administration** menu. This opens the **Video analysis (iCat)** dialog.
2. Select a camera in the camera tree and in the menu select **Add new definition**.
3. In the **Type** pop-up menu choose **Stopped Vehicle Detection** which exposes the configuration settings.
4. In the **Identifier** text field enter a name for this Stopped Vehicle Detection.
5. Draw the region you want to monitor in the preview pane. Just click with the mouse to define the corners of the polygon and close it by crossing an existing edge or by double clicking with the mouse:

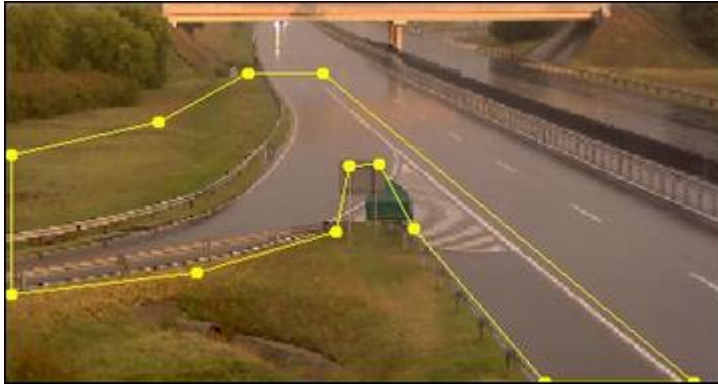

- Adapt the **Alarm time limit (sec)** option which defines after how many second the corresponding event is triggered.

Hint: It is possible to set up more than one Stopped Vehicle Detection per camera, e.g. to generate different events for vehicles stopped on the main road or the emergency lane.

15.3.13 Defining Wrong Way Detection

NetavisObserver 4.5 introduced iCat Traffic and with it Wrong Way Detection. It detects vehicles going into the wrong direction on a normal road or special segments such as an emergency or exit lane.

Here are the steps for configuring Wrong Way Detection:

- Choose **Video analysis (iCat)** from the **System administration** menu. This opens the **Video analysis (iCat)** dialog.
- Select a camera in the camera tree and in the menu select **Add new definition**.
- In the **Type** pop-up menu choose **Wrong Way Detection** which exposes the configuration settings.
- In the **Identifier** text field enter a name for this Wrong Way Detection.
- Draw the region you want to monitor in the preview pane. Just click with the mouse to define the corners of the polygon and close it by crossing an existing edge or by double clicking with the mouse:

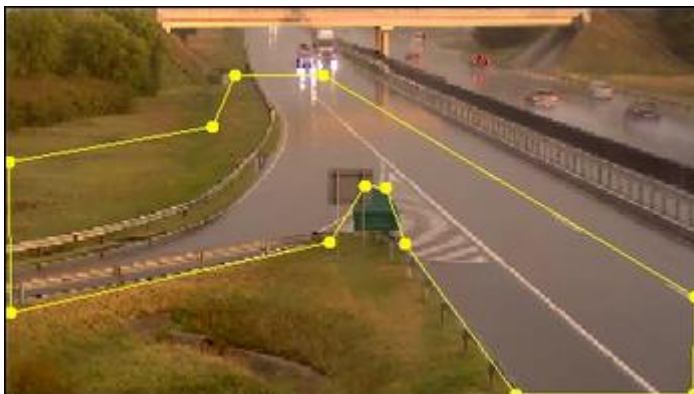

- Next the detector learns the typical direction of the traffic inside the previously defined region. Depending on the amount of traffic the duration for this learning process can range from a couple of hours to a day. When the learning process is completed every vehicle going into a direction other than the usual one will be detected as a wrong way driver and an event will be generated.

If the typical traffic direction changes temporarily, e.g. because of construction work, the detector can be reset: Select the Wrong Way Detection definition, right-click on it, and select **Reset traffic direction learning**.

Please note: The Wrong Way Detection region should always include road parts where the typical traffic direction is observable. For example, if the scenario is to detect drivers traveling the wrong way on the emergency lane it is not a good practice to draw the detection region tightly around the emergency lane. Rather the solution is to extend the detection region to include the lane next to the emergency lane, so the detector can compare a vehicle's route to the direction learned on the adjacent lane.

Hint: It is possible to set up more than one Wrong Way Detection per camera, e.g. to generate different events for vehicles going the wrong way on the main road or an exit lane.

15.3.14 Defining Number Plate Recognition

NetavisObserver 4.6 introduced iCat Number Plate Recognition that can detect number plates for use in vehicle entry, parking, and free flow scenarios.

Note: iCat Number Plate Recognition is a separate module which needs to be enabled with an appropriate license key and - depending on the specific configuration - a USB hardware dongle.

The basic steps for setting up Number Plate Recognition in Observer are:

1. Configure an iCat Number Plate Recognition definition (which is covered in this section).
2. (Optional) Configure the desired NPR lists (please see *18 NPR List Management* on page 178 for more details).
3. (Optional) Configure desired actions for number plates included or excluded in NPR lists (please see *17 Rule Administration* on page 172 for more details).

Here are the steps for configuring iCat Number Plate Recognition:

1. Choose **Video analysis (iCat)** from the **System administration** menu. This opens the **Video analysis (iCat)** dialog.
2. Select a camera in the camera tree and in the menu select **Add new definition**.
3. In the **Type** pop-up menu choose **Number Plate Recognition** which exposes the configuration settings.
4. In the **Identifier** text field enter a name for this iCat Number Plate Recognition definition.
5. Draw the region where the number plates appear in the preview pane. Just click with the mouse to define the corners of the polygon and close it by crossing an existing edge or by double clicking with the mouse:

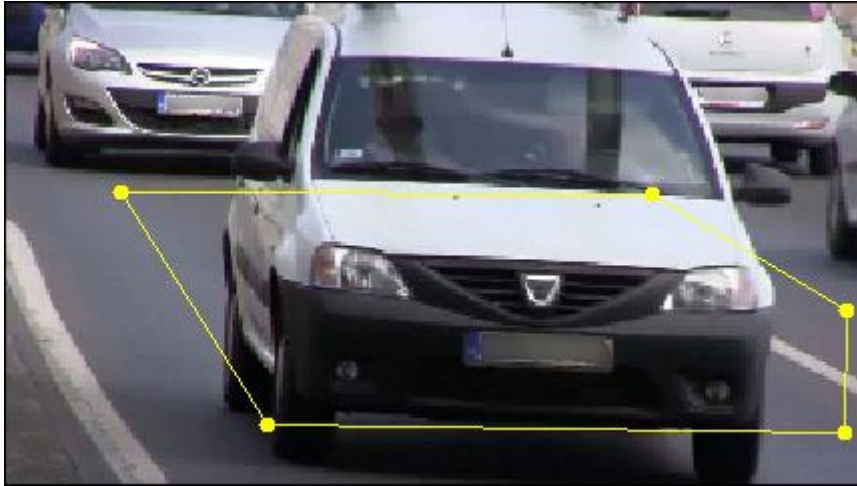

6. Select in which **Region** the system is used (please refer to the [iCat NPR datasheet available on our website](#) for the complete list of countries whose number plates are supported):

- **Europe and Russia**
- **Arabian Peninsula**
- **North Africa**
- **Southeast Asia**
- **Pakistan**
- **Central Asia**

If possible iCat NPR also detects which specific country a number plate is from. The detected country is then shown in the corresponding event details and can also be used in event searches.

Note: This option has to be configured in accordance with the license running on your system.

7. Set the **Event suppression time (sec)** which filters out repetitive iCat NPR events, e.g. when cars are idling in front of a camera.

The default event suppression time of 10 seconds means that after an iCat NPR event for a number plate has been generated, a second event for the same car will only be generated if it leaves the detection region for 10 seconds and then moves back into it.

8. Select the **Minimum plate length** whereby you can choose values between 1 and 5. Recognized number plates with fewer than this minimum length will be discarded and not stored in the event database. Please note that whitespaces are excluded from the minimum plate length.
9. Select the Number Plate Recognition **Scenario**:
- **High speed** is used for free flow scenarios
 - **Slow speed** is used for vehicle entry, parking, and similar scenarios

Note: This option has to be configured in accordance with the license running on your system.

10. Check or uncheck the **Motion detection trigger** checkbox (only available for **Scenario: Slow Speed**). If this option is enabled number plate recognition is only attempted after a motion is detected in the image whereby the threshold is a 5% pixel change in the previously selected detection region.

11. Check or uncheck the **Fast detection** checkbox. If this option is enabled then the first number plate recognition of a given plate will create a corresponding event, else three consecutive recognitions are needed for the event to be created.
12. Check or uncheck the **Disable learning** checkbox. If this option is checked then the initial learning period is disabled.
13. Check or uncheck the **Get color information** checkbox. It is only available for some regions (e.g. Arabian Peninsula) where the color of the plates has a significance. The detected color is then shown in the corresponding event details and can also be used in event searches.
14. Check or uncheck the **Country/region only** checkbox. If this option is checked then only the country/region of a number plate rather than the full plate is read by the system.
15. There is also an option to **Set minimal plate size**. Clicking the button opens a separate window with a snapshot of the camera's videostream and you can draw the minimal plate size with the mouse on that snapshot. Number plates which are smaller than this rectangle will not be detected and will not create an event. For increased accuracy you can resize this snapshot window by clicking and dragging on its corners or edges. A previously configured minimal plate size can be removed by clicking the **Remove minimal plate size** button.
16. Next the detector learns the typical location of the number plates inside the previously defined region. The duration of this learning process depends on the number of vehicles passing through the region and the previously selected **Disable learning** option. During this learning period a corresponding message appears in the camera ports of the Online Monitor where the camera is shown, no number plates will be recognized, and no Number Plate Recognition events will be generated.

Note: Only one **Number Plate Recognition** iCat definition can be created per camera.

15.3.15 Defining a Dynamic Privacy Mask

Netavis Observer 4.7 introduced dynamic privacy masks which expand upon the original NETAVIS Privacy Mask to provide dynamic privacy protection for customers and employees.

This is an example of a dynamic privacy mask hiding a person walking around an office:



Please note:

- No object tracking region is needed for a dynamic privacy mask.
- Currently, dynamic privacy masks are not shown in Client for Smartphone & Tablet, Client for iPad, Mobile Client, Layout Navigation, Video4Web, and Video Wall Control.

Here are the steps for creating a dynamic privacy mask:

1. Choose **Video analysis (iCat)** from the **System administration** menu. This opens the **Video analysis (iCat)** dialog.
2. Select a camera in the camera tree and in the menu select **Add new definition**.
3. In the **Identifier** text field enter a name for this dynamic privacy mask.
4. In the **Type** pop-up menu choose **Dynamic privacy mask** which exposes the configuration settings.
5. Under the camera preview choose the **Rectangle** or **Polygon** checkbox.
6. Now you can draw the area where moving objects should be covered with the dynamic privacy mask with the mouse in the preview pane. For a polygon you just click with the mouse to define the corners of the polygon. You close the polygon by crossing an existing edge or by double clicking with the mouse.
7. Select the desired **Sensitivity** whereby this setting should usually be left at **Normal** and only be modified if you are not satisfied with the dynamic privacy mask performance.
8. Set the desired **Learning time (sec)** (default value: 30 seconds) which defines how long the entire previously selected area will be covered before the dynamic privacy mask becomes active.
9. Set the desired **Make union of masks (msec)** (default value: 200 milliseconds) which defines the duration for which a mask is retained on an area.
10. Check or uncheck the **Slow learning** checkbox depending on the requirements. With this option the adaptation to changing environments takes longer (approximately 1 hour). This means that objects can stop for longer periods of time before they are no longer detected. It is recommended that this option is only used wenn the dynamic privacy mask is started in a static situation with few movements.

15.3.16 Scheduling iCat video analytics and recordings

With Netavis Observer 5.1 the previously available **Camera admin** page "Scheduling" has been replaced by the newly designed camera properties page, an updated camera wizard (see *4.2 Adding a new camera and basic configuration* on page 31 for details), and Schedule Admin (see *21 Schedule Admin* on page 187 for details). Please see the referenced chapters and sections for information on how to schedule iCat video analytics and related recordings.

15.4 Working with iCat

In this section you will learn about:

- Watching iCat information live in the **Online monitor** and also when replaying recordings.
- Displaying heat maps in the **Online monitor**.
- Generating reports on iCat events like people counting and stopped objects.

15.4.1 Displaying iCat information in the Online Monitor and when playing recordings

For each camera that has active iCat schedules enabled you can display additional iCat information like object markers, bounding boxes, and event trigger fields in the **Online monitor** and also when playing back recordings in the **Archive player** or an exported **SAFE Player**.

Here is an example of additional iCat information displayed:



To choose what iCat information to display you have these options:



In the **Online Monitor** in the view port of a camera that has iCat processing enabled the view port **Control Menu** menu offers an **iCat info display** menu. For setting the display for all view ports in a view the same menu is also available in the view's **Control Menu - Set parameters of all view ports**.

In the **Archive player's Control Menu** you can select the iCat information to be shown via **iCat - iCat info display**.

The **iCat info display** menu allows you to select from various display options: For each of these options you can select **Show always**, **Show on mouse over**, and **Do not show**. For some you also can select **Show on event**.

The display options are:

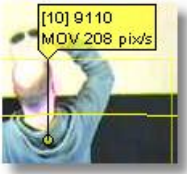
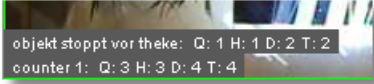
Field label	Description
All information	Displays all available iCat information.
Tracking boundaries	Defines whether the object tracking region boundaries should be shown.
Event trigger lines/boxes	Defines whether the event triggers like tripwires (including arrows indicating the direction of the tripwire) and object starting/stopping fields should be shown.
Object markers	Defines whether object markers should be displayed. Object markers show the object ID and information about the state of the object (MOV = moving, STP = stopped, LOUNGE = move just a little bit), size and speed.

Field label	Description
	 <p>In this example object ID is [10], object size is 9110 pixels, and the object is moving with a speed of 208 pixels/sec.</p>
<p>Event count fields</p>	<p>Defines whether the event count fields are to be displayed in the lower left corner of the view port. When enabled the count information will be displayed for each event trigger separately in the form of Q for last quarter of an hour, H for last hour, D for day and T for total since setup. Here is an example:</p>  <p>There are two event triggers: a field for counting stopped objects and a people counting tripwire (counter 1).</p>
<p>Object bounding boxes</p>	<p>Defines whether object bounding boxes should be displayed. Here is an example of an object bounding box displayed:</p>  <p>Please note that also the object marker and the event triggers are displayed.</p>

15.4.2 Displaying heat maps

For every camera you can display heat maps as overlays to the normal video stream in the **Online monitor** and also in the **Archive player**.

The requirements for displaying heat maps for a camera are:

- an object tracking region with enabled heat map data collection (see 15.3.3 *Defining an object tracking region* on page 147 for details)
- an enabled and currently running iCat schedule for that object tracking region

Below you can find an example of an object count heat map:

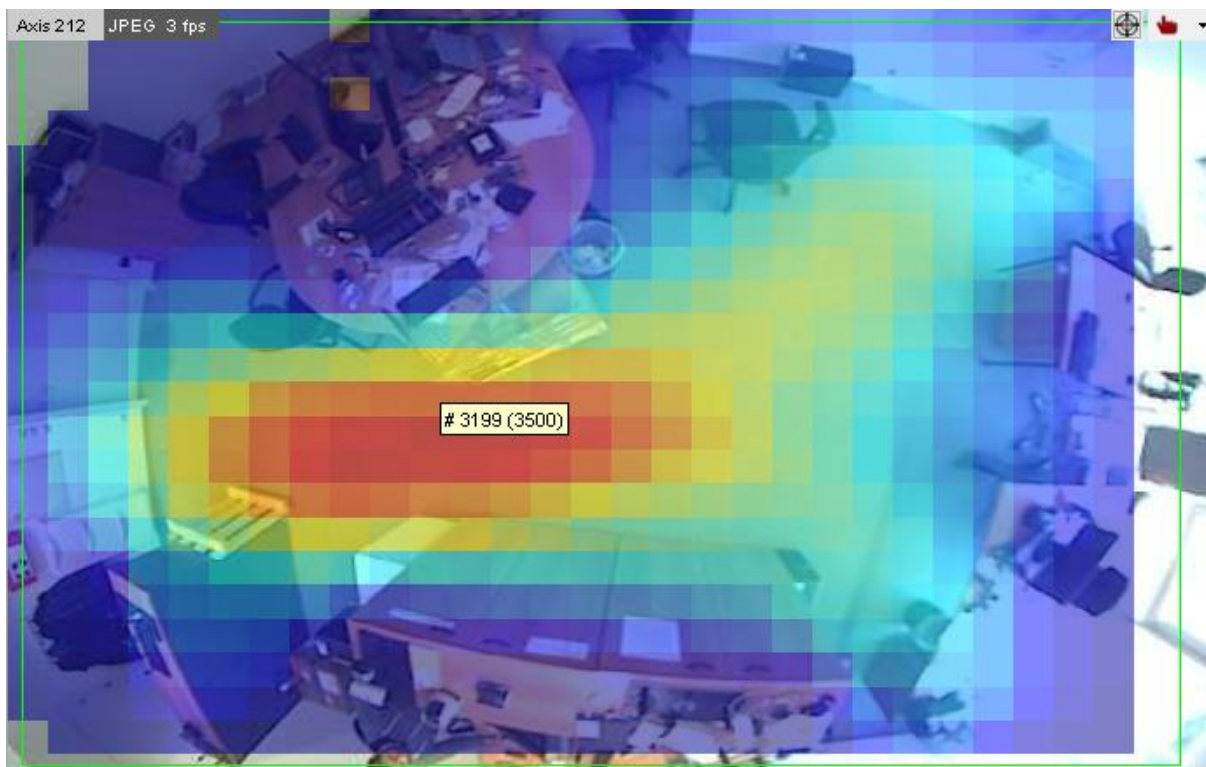

In the **Online monitor** you can display these heat maps by choosing the desired heat map type from the view port's right-click menu - **iCat heat maps - Type**:

- Object count
- Object speed
- Stopped object count
- Object stopping time

Next, in the **iCat heat maps - Show** menu you can choose when to show the heat maps:

- Show always
- Show on mouse over
- Do not show

For showing the heat maps for all view ports in a view the same menu is also available in the view's **Control Menu - Set parameters of all view ports**. In the **Archive player's Control Menu** you can select the heat map type to be shown via **iCat - iCat heat maps**.

In the screenshot above you see an example of the object count heat map in an office situation. Cold colors (such as blue) mean few object counts and hot colors (such as red) mean high object counts.

When you move the mouse over the view port you can see the raw heat map data for the corresponding heat map type:

- Object count: accumulated object count
- Object speed: average speed of objects
- Stopped object count: accumulated stopped object count
- Object stopping time: accumulated stopped object time

In the screenshot above the count in the middle of the screen would be 3199 objects. If you are normalizing the type of heat map (see *11.2 Setting Observer server parameters* on page 109 for further information) then the max value set there is displayed in brackets (3500 in the screenshot above).

As a comparison, here you see the heat map of the stopped object counts of the same camera:

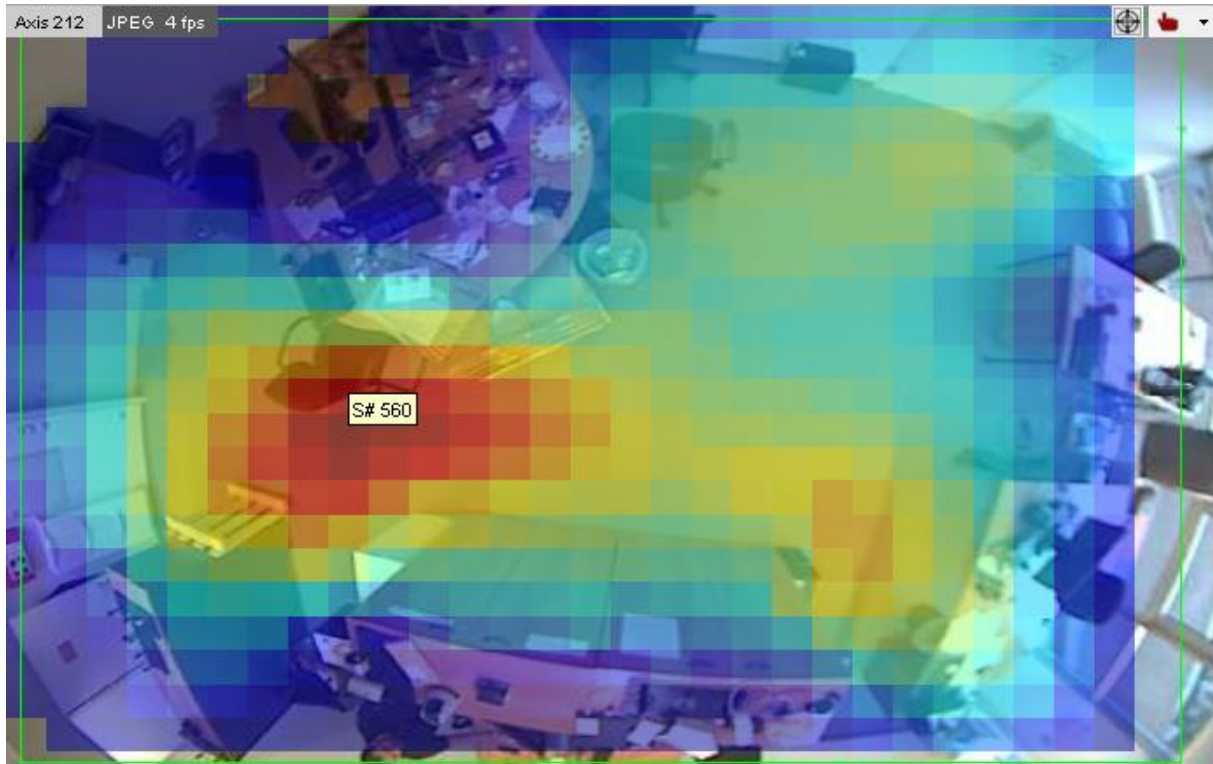

Notice the difference in coloring. You see that people only very seldomly stop in the right side of the office but stop very often in the middle near the chair.

Resetting all the heat maps on a server:

To reset all the heat maps on a server follow these steps:

- Manually: Open the **iCat admin**, right-click anywhere on the window, and select **Reset all heat map values on this host**.
- Automatically: Configure the **Heatmap statistics reset method** option in the Host Admin (see *11.2 Setting Observer server parameters* on page 109).

Resetting the heat maps of individual cameras:

1. Choose **Video analysis (iCat)** from the **System administration** menu. This opens the **Video analysis (iCat)** dialog.
2. Choose the camera and then the corresponding object tracking region.
3. In the menu select **Modify selected definition**.
4. Press **Next** to get to the **Heat map data collection** heat map settings.
5. Disable the checkboxes of those statistics you want to reset.
6. Press the **Save** button to save the changes. Now the heat map data of the disabled types is reset.
7. Now enable the heat map data collection again by repeating the above steps accordingly. Do not forget to press **Save** again.

15.4.3 Working with iCat events

Working with iCat events is the same as working with other events of the Observer event management system EMS (as described in *9 Handling events* on page 92).

Currently, iCat generates events of the following types (as shown in the event type hierarchy dialog of the Event search; see *9.1 Event list and event details* on page 92):

Camera specific messages

State change events

Video analysis (iCat) events

Simple motion detection

iCat object tracking

All events that are generated by iCat (that are not simple motion detection) like people counting, object stopping, and sabotage detection are of type **iCat Object tracking**. Therefore if you want to filter iCat events you have to choose the event type **iCat Object tracking**.

You can differentiate events for the various iCat event triggers by their names. You can also create event statistics reports in Excel XLS format (see *9.3 Generating an event statistics report* on page 97).

16 I/O Device Administration

Netavis Observer 4.6 introduced I/O Device Administration which enables the configuration of I/O devices within the Observer user interface. Adding I/O devices to a Netavis Observer system is now as easy as selecting the model and entering its IP address, port, user, and password.

Note: I/O devices (and their corresponding actions) configured in versions prior to Netavis Observer 4.6 via the XML configuration file will continue to work in Observer 4.6. However if you want to use I/O devices with new features introduced in Observer 4.6 (e.g. Rule Administration) then you will need to remove the previous XML configuration and re-add the I/O device in the I/O Device Administration.

16.1 Configuring I/O devices

1. Choose **I/O device admin** from the System administration menu. This opens the **I/O device admin**:

Port ID	Port name	Port type
1	Relay 1	RELAY
2	Relay 2	RELAY
3	Input 1	DIGITAL_INPUT
4	Input 2	DIGITAL_INPUT
5	Input 3	DIGITAL_INPUT
6	Input 4	DIGITAL_INPUT
7	Input 5	DIGITAL_INPUT
8	Input 6	DIGITAL_INPUT
9	Input 7	DIGITAL_INPUT
10	Input 8	DIGITAL_INPUT
11	Output 1	DIGITAL_OUTPUT
12	Output 2	DIGITAL_OUTPUT
13	Output 3	DIGITAL_OUTPUT
14	Output 4	DIGITAL_OUTPUT

2. To add a new I/O device right-click anywhere in the window and select **Add new device**.
3. In the **Name** text field enter a name for this I/O device.
4. In the **Type** pop-up menu choose the type of I/O device you want to add to the system.

Hint: Device-type specific **Configuration hints** are shown to the right of the text boxes.

5. Next enter the device's **IP address**.
6. Almost all I/O devices also require entering a **TCP/HTTP port** for connecting to it.
7. Additionally many I/O devices require authentication via a **username** and **password**.
8. The device-type specific I/O ports and relays are shown in the table below the configuration text boxes.

Hint: When selecting an Axis Generic or ONVIF Profile S device type you need to **Collect capabilities** before the device's output ports can be shown.

9. You can edit the **Port name** for each I/O port and relay by double-clicking on it.
10. For some devices (e.g. many AXIS cameras, AXIS P8221) you can also configure the **Port type** by double-clicking on it and choosing the desired type from the pop-up menu.

Note: It is important that the port type configuration made here matches the one on the corresponding I/O device's webpage!

11. When you press **Save** Observer will try to connect to the I/O device with the given configuration and a corresponding "I/O device was added" event is generated:

If the connection is not successful or lost at any time a "Connection lost to I/O device" event is generated:

 Connection lost to I/O device "Alarm system" [virtualbox]

12. For any changes of input ports and relays of I/O devices a corresponding event will be generated:

 I/O port "Input 1" value changed from "0" to "1" on "Alarm system" [virtualbox]

13. Finally, you can also **Modify** and **Delete** selected I/O devices via the right-click mouse menu. Corresponding events are again generated when an I/O device is modified or deleted.

16.2 Generic I/O devices

It is also possible to add other TCP/IP based systems to an Observer system as I/O devices. In order to do that an I/O device of the **Type** "Generic TCP" has to be added as described above. The corresponding system or device then has to be configured to send TCP messages to the Observer server's port 10100 with the following syntax:

`statechange,<DEVICE_ID>,<IO_PORT_ID>,<IO_PORT_VALUE>`

So for example changing the value of the first port of an I/O device with ID=1001 to "0" would require the following TCP message:

`statechange,1001,1,0`

 I/O port "Input 1" value changed from "1" to "0" on "Generic Test" [virtualbox]

17 Rule Administration

Netavis Observer 4.6 introduced Rule Administration which enables the simple configuration of a range of actions which are triggered by specific events. For example, the permanent recording of cameras can be started once an alarm system is activated or a barrier can be opened upon the detection of certain number plates. The rule administration is an extensible system which will continue to cover more scenarios in the future.

Note: Actions triggered by I/O devices configured in versions prior to Netavis Observer 4.6 via the XML configuration file will continue to work in Netavis Observer. However, if you want to use Rule Administration you will need to remove the previous XML configuration, reconfigure the I/O device in the I/O Device Administration, and then add the corresponding actions via Rule Administration (described in this chapter).

17.1 Configuring rules

1. Choose **Rule admin** from the System administration menu. This opens the **Rule admin**:

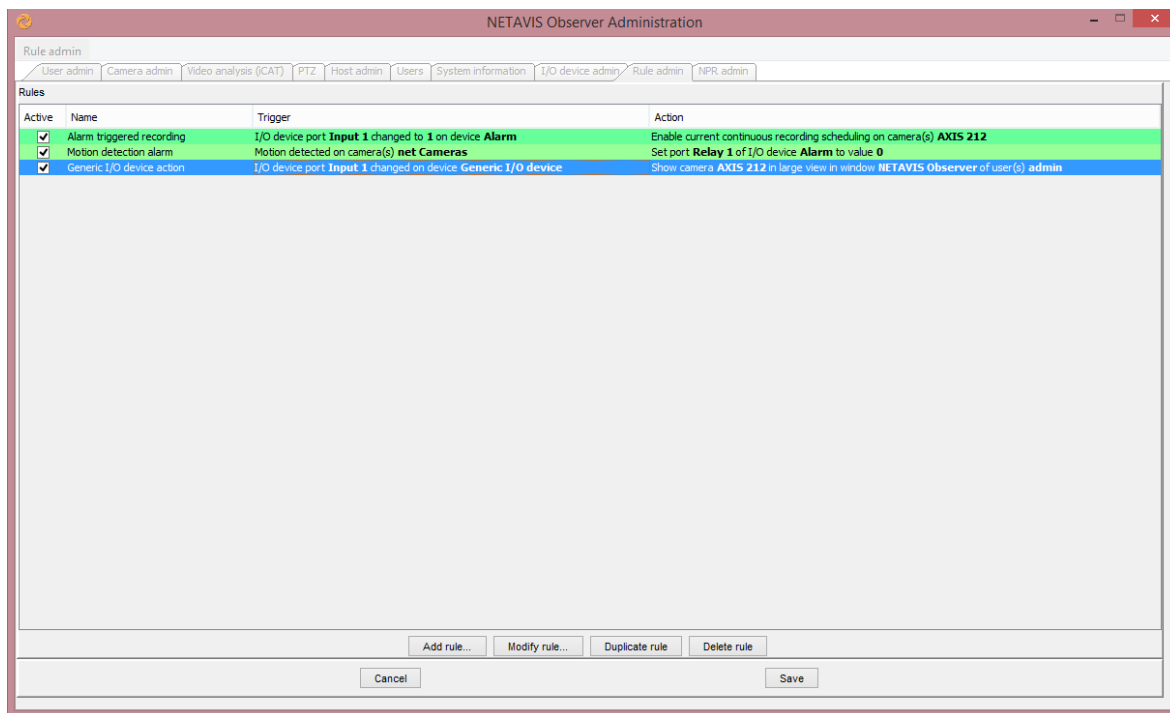

2. To add or modify rules right-click anywhere in the window and select **Modify rules**.
3. To add a new rule click on the **Add rule...** button which opens the Rule Editor:

The screenshot shows the 'Rule Editor' window with the following configuration:

- Rule name:** Motion detection alarm
- Trigger type:** Motion detected
- Cameras:** net Cameras
- Definition name:** Any definition
- Action type:** Set I/O device port value
- I/O device:** Alarm
- I/O port:** Relay 1
- Port value:** 0
- Switch value back after:** 0 ms

4. Enter a name for this rule in the **Rule Name** text field.
5. Since NetavisObserver 5.1 it is also possible to select a **Schedule** (previously defined in the Schedule Admin) for each rule, whereby the default value is **Always**.
6. Next you choose and configure a **Trigger type** whereby NetavisObserver5.1 currently supports the following triggers:
 - a. **Motion detected:** In its basic configuration the trigger is any motion detection (option: **Any definition**) on one or multiple cameras and/or camera groups which can be selected. Additionally, it is also possible to limit the trigger to only occur when any of the selected iCat Motion Detection definitions occurs (option: **Any selected definition**). When selecting more than one camera then only the subset of identically named iCat Motion Detection definitions available on all cameras is shown here.
 - b. **Connection to camera lost:** You can select one or multiple cameras and/or camera groups. The trigger is if NetavisObserver loses the connection to one of them.
 - c. **Connection to camera restored:** You can select one or multiple cameras and/or camera groups. The trigger is if NetavisObserver restores the connection to one of them.

- d. **I/O device port value changed:** You can select any I/O device which was previously added via the I/O Device Administration (see *UNRESOLVED CROSS REFERENCE* I/O Device Administration on page 170). Then you can choose any of its input ports or relays and define whether the port value changing from **0->1**, **1->0** or **Any** value change is used as the trigger.
 - e. **Number plate detected:** In its basic configuration the trigger is simply a number plate being detected on one or multiple cameras and/or camera groups which can be selected. Additionally it is also possible to limit the trigger to only occur when a number plate **is in** or **is not in** one or multiple NPR lists (see *18 NPR List Management* on page 178).
 - f. **Object crossed field or tripwire:** In its basic configuration the trigger is any object is crossing field and object crosses tripwire iCat detection (option: **Any definition**) on one or multiple cameras and/or camera groups which can be selected. Additionally it is also possible to limit the trigger to only occur when any of the selected iCat Object is Crossing Field and Object Crosses Tripwire events occurs (option: **Any selected definition**). When selecting more than one camera then only the subset of identically named iCat Object is Crossing Field and Object Crosses Tripwire definitions available on all cameras is shown here.
 - g. **Object started moving in field:** In its basic configuration the trigger is any object starts moving in field iCat detection (option: **Any definition**) on one or multiple cameras and/or camera groups which can be selected. Additionally it is also possible to limit the trigger to only occur when any of the selected iCat Object Starts Moving in Field events occurs (option: **Any selected definition**). When selecting more than one camera then only the subset of identically named iCat Object Starts Moving in Field definitions available on all cameras is shown here.
 - h. **Object stopped in field:** In its basic configuration the trigger is any object stops in field iCat detection (option: **Any definition**) on one or multiple cameras and/or camera groups which can be selected. Additionally it is also possible to limit the trigger to only occur when any of the selected iCat Object Stops in Field events occurs (option: **Any selected definition**). When selecting more than one camera then only the subset of identically named iCat Object Stops in Field definitions available on all cameras is shown here.
7. By clicking on the **Add action** button you can then add one or multiple actions which will be executed when the trigger configured above occurs. NetavisObserver5.1.0 currently supports the following actions:
- a. **Enable current continuous recording scheduling:** You can select for which **Camera(s)** the current continuous recording scheduling will be enabled: either the **camera from the event** which triggered the rule or any other camera(s).

Note: This action does not automatically start a continuous recording on the corresponding camera(s)! Rather it simply enables a previously configured continuous recording schedule (see *7.1 Programming archive recordings* on page 72) which is scheduled to run at the current time. Changes of the scheduling can take up to 2 seconds to be executed and no other changes should be made during that time.

- b. **Disable current continuous recording scheduling:** You can select for which **Camera(s)** the current continuous recording scheduling will be disabled: either the **camera from the event** which triggered the rule or any other camera(s).

Note: This action does not automatically stop a continuous recording on the corresponding camera(s)! Rather it simply disables a previously configured continuous recording schedule (see *7.1 Programming archive recordings* on page 72) which is scheduled to run at the current time. Changes of the scheduling can take up to 2 seconds to be executed and no other changes should be made during that time.

- c. **Enable current iCat scheduling:** You can select for which **Camera(s)** the current iCat scheduling will be enabled: either the **camera from the event** which triggered the rule or any other camera(s).

Note: This action does not automatically start a Video Analysis (iCat) recording on the corresponding camera(s)! Rather it simply enables previously configured Video Analysis (iCat) schedules (see *7.1 Programming archive recordings* on page 72) which are scheduled to run at the current time. Changes of the scheduling can take up to 2 seconds to be executed and no other changes should be made during that time.

- d. **Disable current iCat scheduling:** You can select for which **Camera(s)** the current iCat scheduling will be disabled: either the **camera from the event** which triggered the rule or any other camera(s).

Note: This action does not automatically stop a Video Analysis (iCat) recording on the corresponding camera(s)! Rather it simply disables previously configured Video Analysis (iCat) schedules (see *7.1 Programming archive recordings* on page 72) which are scheduled to run at the current time. Changes of the scheduling can take up to 2 seconds to be executed and no other changes should be made during that time.

- e. **Show window:** You can select which **Window** to show on a user's screen by selecting the **User(s)** and **Window** which will be shown. Optionally, it is also possible to configure **Minimize window after** (in seconds) and the **Limit to IP address** (to limit the action to clients connected from the respective IP address) options.
- f. **Show camera in large view:** You can select which **Camera** to show in the large view: either the **camera from the event** which triggered the rule or any other camera. Additionally you need to configure the **User(s)** and **Window** where the camera will be shown. When multiple users are selected only the subset of commonly available windows are shown here.
- g. **Show view:** You can configure which view to show whereby there are three different **Display modes:**
- **Show view:** Here you can select in which specified **View** of a selected **User** and **Window** the camera from the triggering event or other cameras are shown. Optionally, it is also possible to configure the **Limit to IP address** option to limit the action to clients connected from the respective IP address.
 - **Show camera in view replacing the oldest camera:** The newest events are always displayed in the "oldest" view ports (the view ports that stood there the longest without a camera change). Thus it is possible to create a view where always cameras with the newest events are displayed. The other options are identical to the **Show view** display mode.
 - **Shift camera in view shifting older cameras:** The newest events are always displayed in the top left view port with all other camera views shifting towards the bottom right. Cameras in the lower right view port are removed from the view. Thus it is possible to create a view where cameras with the most recent events are always

displayed in the top left position view port. The other options are identical to the **Show view** display mode.

- h. **Set I/O device port value:** You can select any **I/O device** which was previously added via the I/O Device Administration (see *16 I/O Device Administration* on page 170). Then you can choose one of its output **Ports** or relays and define whether the **Port value** should be set to **0** or **1**. Optionally you can define whether to **Switch the value back** to the opposite value after a certain amount of time (in milliseconds).
- i. **Set PTZ position:** You can select a previously configured **PTZ position** of a **Camera** and define a **Minimal stay time** for which the camera will remain at that position.

Note: This action does not work if the camera currently follows an automatic PTZ route!

- j. **Play sound:** You can select one of the default sounds from the list and choose for which user(s) the sound should be played. Additionally it's also possible to upload a custom sound by clicking on the **...** button (whereby .au and .wav files are supported).
- k. **Send email:** You can select NetavisObserver users as **Recipient users** and **CC users** of e-mail notifications (do note that these users need to have a filled in **e-mail address** in the **User admin**). Additionally arbitrary e-mail addresses not associated with any Observer users can be added in the **Recipient addresses** and **CC addresses** fields whereby multiple addresses have to be separated by a comma (,).



For the **Subject** of the corresponding e-mail it is possible to either choose **Use event text as subject** (e.g. *Object stopped in field "Stopped person" of camera "Main Entrance"*) or **Specify subject** and entering a custom text.

Similarly for the **Body** of the e-mail it is possible to either choose **Use event details as message** (which adds all the information also visible in the **Event details** dialog of the trigger event) or **Specify message** and entering a custom text. Additionally the **Include trigger image** option can be checked so if the trigger event contains an image it will be attached to the e-mail.

Note: Your NetavisObserver server needs to have a corresponding SMTP mail server and networking setup configured in order to be able to send e-mail notifications (please see the document *NETAVIS Observer Server Installation and Administration* and specifically the "Edit network settings" section for further information). Also note that NetavisObserver has a 10MB limit for e-mail attachments. So if the **Include trigger image** option is checked and the associated image is larger than 10MB then the e-mail notification will not be sent.

- l. **Generate custom event:** Using the **Edit custom events** button you can enter the **Custom event editor** which allows you to add fully customizable event types. You can **Add**, **Modify** or **Delete** these custom events which are defined by their **Event type**, up to 5 **Event parameters**, and a corresponding **Event text**. These custom events can then be generated as an action within a rule whereby the custom event parameters can either be copied from the triggering event or entered manually:

Note: The length of all event parameter names combined cannot exceed 200 characters!

- m. **Send TCP message:** You can enter a destination **IP Address** and **Port** to which the configured **Message** which will be sent upon the rule's execution.
 - n. **HTTP request:** You can enter a **URL**, choose between the GET or POST **Method** and add an optional **Username**, **Password**, and **Message** and the configured request will be made upon the rule's execution.
8. You can also delete actions by clicking on the delete button  next to each action.
 9. Press **OK** to create the rule. If you forgot to specify any mandatory options then an icon  will pop up next to it.
 10. Press **Save** to store the changes. For any changes also a corresponding event will be generated :

 Rule list was modified by "Video admin user" [virtualbox]
 11. Existing rules can be enabled and disabled via the **Active** checkbox next to each rule. They can also be modified by double-clicking on one or selecting it and pressing the **Modify rule...** button.
 12. Finally, you can also **Duplicate** and **Delete** selected rules via the corresponding buttons.

18 NPR List Management

NetavisObserver 4.6 introduced iCat Number Plate Recognition that can detect number plates for use in vehicle entry, parking, and free flow scenarios.

Note: iCat Number Plate Recognition is a separate module which needs to be enabled with an appropriate license key and a USB hardware dongle.

The basic steps for setting up Number Plate Recognition in Observer are:

1. Configure an iCat Number Plate Recognition definition (please see *15.3.14 Defining Number Plate Recognition* on page 161 for more details).
2. (Optional) Configure the desired NPR lists (which is covered in this section).
3. (Optional) Configure desired actions for number plates included or excluded in NPR lists (please see *Using Rule Administration* for more details).

18.1 Configuring number plate lists

1. Choose **NPR admin** from the System administration menu. This opens the **NPR admin**:

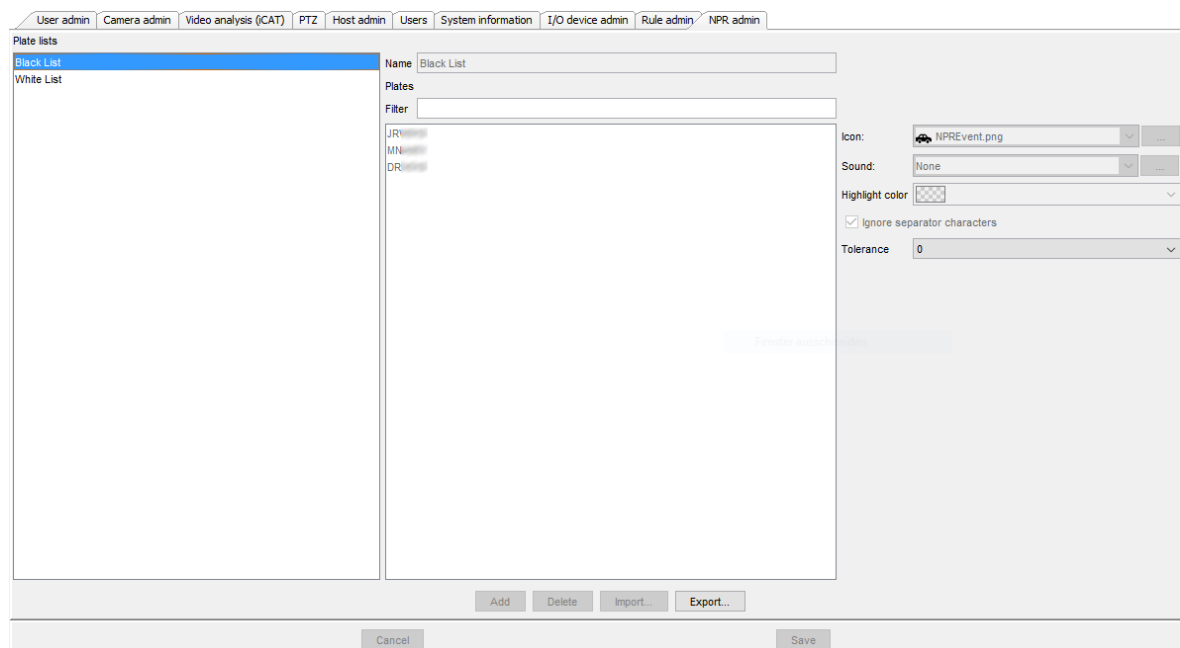

2. To add a new number plate list right-click anywhere on the window and select **Add new list**.
3. In the **Name** text field enter a name for this NPR list.
4. You can choose a specific **Icon**, **Sound**, and **Highlight color** for the corresponding event when it is shown in the **Event list**.
5. The **Ignore separator characters** checkbox defines whether separator characters in the number plate (such as spaces) should be considered when matching detected number plates against the selected NPR list.
6. Select the **Tolerance** (in number of characters) whereby you can choose 0, 1 or 2.

Selecting 0 means that a detected number plate has to exactly match a number plate in the NPR list in order to be associated to it.

Selecting 1 character tolerance means that the detected number plate and a plate in the selected NPR list have the same length but at most one character is different OR the detected number plate has one character less or more than a plate in the selected NPR list.

Selecting 2 characters tolerance means that the detected number plate and a plate in the selected NPR list have the same length but at most two characters are different OR the detected number plate has one character less or more and at most one character is different than a plate in the selected NPR list.

7. There are two options to add number plates to this list:
 - a. You can manually add number plates by clicking on the **Add** button at the bottom:



To add multiple number plates you can either separate them with a comma or add them in separate lines by pressing ENTER after each number plate.

- b. You can import number plates stored in text-, CSV- and Excel-files by clicking on the **Import** button at the bottom and selecting the corresponding file from your hard drive.

Note: When importing number plates with non-standard characters (e.g. German umlauts) ensure that the files to be imported are encoded with UTF-8. Please also note that for example Microsoft Excel does not provide support for saving CSV-files with UTF-8 encoding!

8. By selecting one or multiple number plates and clicking on the **Comment** button it is possible to add comments to number plates (e.g., the owner or type of a car). These comments are also included in any number plate events that are generated when the corresponding number plate is detected.
9. Once added you can also filter the number plates by entering characters into the **Filter** textbox:

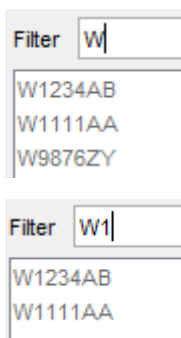

10. Press **Save** to store the changes. For any changes also a corresponding event will be generated :

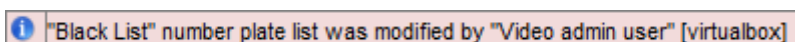

11. You can also **Modify, Delete** and **Export** (as text-, CSV- and Excel-files) selected lists of number plates. Corresponding events are again generated when an NPR list is modified or deleted.

Note: As of Netavis Observer 5.0.1 it is also possible for 3rd party systems to modify number plate lists via SNAP XML, SNAP URL, and the SNAP Java SDK. For further information please refer to the corresponding SNAP API documentation.

19 Automatic Export

Netavis Observer 4.7 introduced an Automatic Export tab for configuring the automatic export and upload of event statistics, events including their parameters, and heat maps to Netavis sMart Data Warehouse and other 3rd party systems.

19.1 Configuring automatic exports

1. Choose **Automatic export** from the System administration menu. This opens the **Automatic Export** tab:

2. To add or modify automatic exports right-click anywhere on the window and select **Modify exports**.
3. To add a new automatic export click on the **Add** button.
4. Per default the **Enabled** checkbox is checked which means that the automatic export is activated.
5. In the **Name** text field enter a name for this automatic export.
6. Select the **Type** of the automatic export where you are presented with three options:
 - **Event statistics** are CSV files containing aggregated statistical values, equivalent to what can be manually obtained with the event statistics export menu (e.g. 3 people were counted at an entrance in the past hour). For these exports you can additionally select the desired types of **Events**, the **Cameras**, and the **Resolution** of the export (15 minutes, 1 hour, 1 day, and 1 week).
 - **Events** are CSV, HTML, JSON or XLS files containing the full event details, equivalent to what can be manually obtained by exporting the result of an event search (e.g. vehicle with

number plate W-123AB was detected at 11:03 on July 25). For these exports you can additionally select the desired types of **Events**, the **Cameras**, and if only a single event type is selected also specific event parameter requirements.

- **Heatmaps** are CSV files containing the relative heatmaps data (e.g. of stopped object time).
7. For event statistics and events the default **Export period** which defines how often the automatic export is uploaded is 1 day, other options are: 15 minutes, 1 hour, 1 week, and 1 month. For heat maps the default value is 1 hour, the alternative is 1 day, and the period has to be configured via the "Heat map export period" option in the **Host Admin**.
 8. **Destination(s)** are the servers such as Netavis sMart Data Warehouse and other 3rd party systems to which the automatically generated export files are uploaded. To add a new destination click on **Edit destination(s)** which opens the **Upload destination editor**:

1. To add a new destination click on the **Add** button.
 2. In the **Name** text field enter a name for this automatic export.
 3. Select the **Protocol** which should be used for the upload whereby **FTP**, **FTPS**, and **SFTP** are supported.
 4. Enter the destination **Address** which can be an IP address or a domain.
 5. Enter the **Port** on the destination system.
 6. Enter the **Directory** where the files should be uploaded to (which is relative to the home directory of the user used to connect to the destination system).
 7. Enter the **Username** which should be used to connect to the destination system.
 8. Enter the **Password** for the corresponding username.
 9. (SFTP-only: Upload the **Certificate** for the corresponding username.)
 10. You can test the configuration by pressing the **Test connection** button.
- If any part of the configuration is missing or erroneous a warning symbol will be shown: ⚠
 - You can also **Delete** a selected destination via the corresponding button.

9. The **File prefix** text box allows to add a specific prefix to the name of the automatically generated export file.
10. The **Export delay (min)** defines how many minutes an export is delayed which can be useful in systems with unreliable connections between NCS and NUS servers.
11. The **Retention time (days)** defines how long the automatically generated export files are stored on the Netavis Observer server. The default value is 7 days and it can be changed by entering a different value in the text box.
12. The **Export format version** defines the naming schema of the exported files:

- **Event statistics:**

- o v1: Original naming schema (e.g. *event-statistic_v1_h2663615583332447065_20180313T180000+0100_20180313T181459+0100.csv*)

- **Events:**

- o v1: Original naming schema (e.g. *event_v1_h2663615583332447065_20180313T181500+0100_20180313T182959+0100.csv*)

- **Heatmap:**

- o v1: Original naming schema (e.g. *heatmap_v1_h2663615583332447065_cam3-1_oc_20180313T181500+0100_20180313T182959+0100.csv*)
- o v2: Additional naming schema which also contains the name of the corresponding iCat definition (e.g. *heatmap_v2_h2663615583332447065_cam3-1_zone1_oc_20180313T181500+0100_20180313T182959+0100.csv*)

Note: sMart Data Warehouse up to 3.1 only supports heatmap naming v1!

13. Press **Save** to store the changes.
14. You can also **Delete** a selected automatic export via the corresponding button.
15. If any issues occur during the export or upload a corresponding system event will be generated:

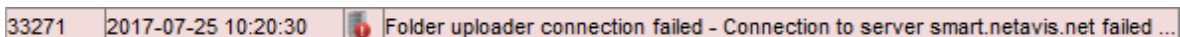

16. Users with the "Enable download of exported files" permission (see 5.2 *Setting general user privileges* on page 46 for details) can download these automatically created files on the server's web page by clicking on **Download exported files** link:



Download exported files: events

File name	Last modification time (CET)	Length (kbytes)
-----------	------------------------------	-----------------

Download exported files: event statistics

File name	Last modification time (CET)	Length (kbytes)
-----------	------------------------------	-----------------

Download exported files: heatmaps

File name	Last modification time (CET)	Length (kbytes)
-----------	------------------------------	-----------------

© 2002 - 2017 NETAVIS. All rights reserved.

20 External Device Administration

Netavis Observer 4.8 introduced External Device Administration to support the configuration and use of devices such as 3D sensors within the Observer user interface. Adding such devices to a Netavis Observer system is now as easy as selecting the model and entering its IP address, port, username, and password.

Note: The configuration of counting lines and zones needs to be done on the external device's web interface!

20.1 Configuring external devices

1. Choose **External device admin** from the System administration menu. This opens the **External device admin**:

2. To add a new external device right-click anywhere in the window and select **Add new device**.
3. In the **Name** text field enter a name for this external device.
4. In the **Type** pop-up menu choose the type of external device you want to add to the system.

Hint: Device-type specific **Configuration hints** are shown to the right of the text boxes.

5. Next enter the device's **IP address**.
6. Almost all external devices also require entering a **TCP/HTTP port** for connecting to it.
7. Additionally many external devices require authentication via a **username** and **password**.

Hint: For Hella 3D devices the username is "user-role-edit", the default password is "admin", and the default port is: 8091. The password and (REST) port can be changed on the sensor's web interface.

8. It is also possible to define the **icon**, **sound**, and **highlight color** for the resulting **Generic counting** and **Zone alarm** events.
9. Optionally it's also possible to configure thresholds for **zone level alerts** and **dwelling time alerts**.
 - Select the **zone level alerts** checkbox to enable the corresponding zone alert events when the level is above or below a certain threshold.
 - Select the **dwelling time alerts** checkbox to enable the corresponding zone alert events when the level is above or below a certain threshold (in seconds).

Note: For Hella 3D devices the sensor's "max. dwelling time" value is used for the dwelling time alerts!

Hint: In zone monitoring and queue length detection applications these alerts can be used as a trigger for speaker announcements, informing staff to open an additional counter, and many other processes.

10. When you press **Save** Observer will try to connect to the external device with the given configuration and a corresponding "External device was added" event is generated.

If the connection is not successful or lost at any time a "Connection lost to external device" event is generated:

8722809	2018-07-12 17:52:55		Connection lost to device "APS90Outdoor" [showroom]
---------	---------------------	---	---

11. Once the connection to an external device has been established the system will start generating counting and zone events with the latest data from the sensor as well as corresponding alert events when the configured thresholds are crossed. Counting events will be generated once every 5 seconds and zone events will be generated every 60 seconds but only when the level and dwelling time are not 0:

Event details ×

Zone report for device "APS90Outdoor", zone "Zone0", All: level: 1, dwell time: 109.0 seconds [showroom]

Name	Value
ID:	8697371
Time of event:	2018-07-11 17:40:21
SendUserNotification	true
Definition	Zone0
Level	1
ObjectType	All
PreviousAvgDwellTime	54.0
PreviousLevel	1
AvgDwellTime	109.0
DeviceName	APS90Outdoor
DeviceID	1
Priority	100
ACKComment	
Classification:	Unclassified

Start live stream Short event replay Go to Archive player

Classify event as: Unclassified ▾

Acknowledge comment:

Acknowledge Acknowledge and next

Previous Next Close

- Finally, you can also **Modify**, **Delete**, and **Clone** selected external devices via the right-click mouse menu. Corresponding events are again generated when an external device is modified or deleted.

21 Schedule Admin

Netavis Observer 5.1 introduced the new Schedule Administration for centralized management of all schedules for continuous recordings, iCat video analytics, and rules.

21.1 Configuring schedules

1. Choose **Schedule admin** from the System administration menu. This opens the **Schedule admin**:

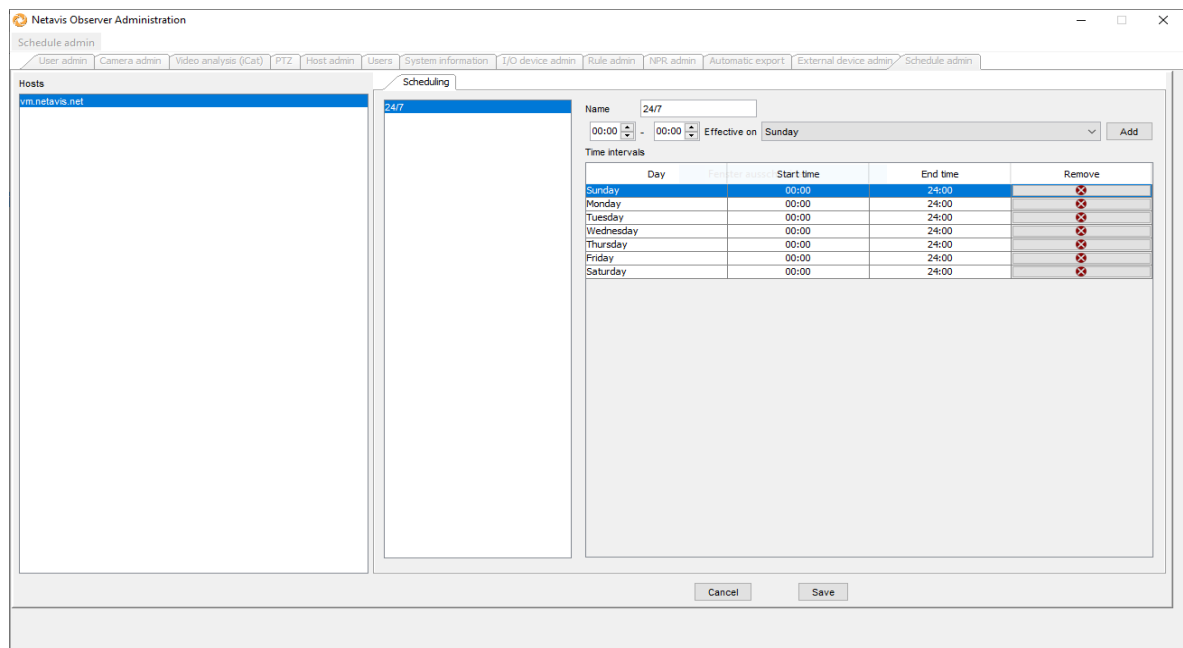

2. A 24/7 schedule is available per default.
3. To add a new schedule right-click anywhere on the window and select **Add new definition**.
4. Enter a **Name** for the schedule.
5. Set the desired **time interval** of the schedule and choose on which days weekdays it should be effective (default: all).
6. Click on **Add** for the interval to be added to the schedule
7. Continue adding more intervals as needed.
8. Press **Save** to store the schedule.

Existing schedules can be **Modified**, **Duplicated**, and **Deleted** after selection via the right-click menu. Additionally, it is possible to **Add the opposite** for a selected schedule, for example to allow an easy configuration of different schedules for work-days and weekends.

If multiple Netavis Observer servers are connected to each other then the schedules on the NCS are also visible and modifiable from the NUS server.

22 Video walls with Observer

The Observer video wall solution allows you to configure and operate professional video walls using standard Observer servers and clients. Such a video wall can then be controlled by the Video wall control application, which allows you to:

- Handle video walls with up to 10x10 monitors.
- Connect multiple monitors to a single client PC.
- Flexibly control the views and layouts in any of the video wall monitors.
- Maximize individual camera streams on any of the monitors.
- Work with multiple control consoles in parallel.

The video wall control application has been specifically designed for control center personnel to operate video walls. Any configuration of the servers, video wall clients, cameras, recordings, or other administration has to be done in the main Observer client and admin consoles.

Here is the basic architecture of a video wall with Observer:

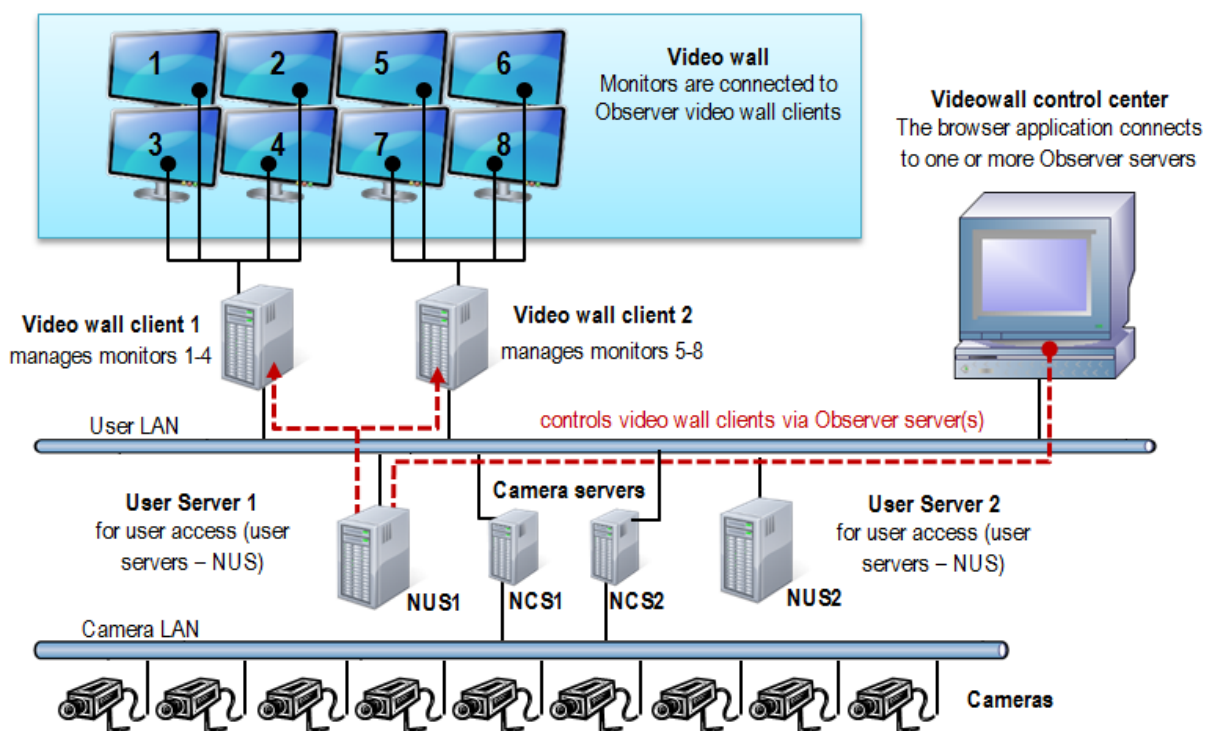

The video wall control application itself runs in a web browser on a PC that serves as the video wall control center. It connects to one of the Observer servers in the network that then in turn controls the Observer video wall clients that directly connect to the monitors of the video wall.

22.1 Setting up a video wall with Observer

22.1.1 General setup considerations

The video wall control application connects to an Observer server (normally a user server – NUS) in order to control the display of the video wall clients. It is possible to choose any server in the network

for that purpose. However, all cameras that you want to display on the video wall must be accessible by this server (i.e. must be configured at this server or must be mounted from other servers).

It is also possible to use more than 1 server for providing the streams for the video wall (this depends on how you setup your server network topology). In such a case the VWCA and also the video wall clients (that directly connect to the monitors) must connect to these servers. For simplicity and easier setup and management of the video wall, we suggest using one Observer server for driving the video wall.

Each video wall client workstation/PC can drive several monitors of the video wall (how many depends on your hardware setup, i.e. graphics card). Each such video wall monitor has to map to one window in the Observer client.

User management for the video wall

You will need a few users to manage video wall functions appropriately. Generally these users must have access rights to all cameras that are to be displayed on the video wall:

- 1 video wall management user (with which you login in to the VWCA).
- For each video wall client workstation/PC you need 1 user

You can create a user group that has privileges and access rights to all relevant cameras and then create the above users belonging to this group (automatically inheriting the privileges and rights).

Please note these special issues:

- It is impossible to display a camera on a video wall monitor which is not available on the server where the video wall client connects to. Depending on your setup, it is therefore possible that you cannot display every camera on any video wall monitor.
- The video wall control application itself does not display live video streams of the cameras but snapshot images for better orientation instead. The real video streams appear in the video wall monitors.

22.1.2 Setting up the video wall

Please follow these steps for setting up the video wall:

1. Configure your Observer server network with all the cameras and other settings.
2. Setup the video wall monitors and the video wall client PCs (how many monitors you can connect to 1 client PC depends on your hardware setup). The video wall clients must run the Observer desktop application.
3. We suggest using 1 specific user per video wall client PC. As indicated above, you can create a user group that has privileges and access rights to all relevant cameras and then create 1 user for each VW client PC. In the example diagram above it would be 2 users with names like VWPC1 and VWPC2.
4. Start the Observer application on the first video wall client PC and login with the user of that client PC (e.g. VWPC1).
5. For each video wall monitor you have to define a separate window in the Observer application (there is a 1 to 1 mapping between video wall monitors and Observer application windows). For each of these windows you can define multiple views with different layouts (you can also add and modify views later on). These views can later on be controlled by the video wall control application.

6. In the Observer application position each of the created windows to the corresponding video wall monitors (and put it in full screen mode). You can do that by dragging the window with the mouse and then maximize the window.
7. When you are done setting up all the video wall client PCs and windows (monitors) you can continue to configure and use the video wall control application (see 22.2 *Controlling the video wall with the control application* on page 190).

22.2 Controlling the video wall with the control application

The video wall control application (VWCA) is a client/server web application, which you can activate from an Observer server (from release 4.4 on). The client part runs within a web browser and needs only minimal computer resources and the server part of the application runs on an Observer server.

You can use any workstation/PC in the network (also your standard Observer client workstation) to run the VWCA client.

Parallel working of multiple VWCAs: It is possible that multiple operators work on the same video wall. In this case Observer always executes the last command no matter who initiated it. Therefore we assume a cooperative multitasking style, which means that the operators have coordinate with each other.

Supported browsers:

- Mozilla Firefox 10.0 or higher
- Google Chrome 17.0 or higher
- Other browsers with HTML5 compatibility

22.2.1 Starting the video wall control application

You can start the video wall control application (VWCA) in a web browser with the following URL:

```
<your server address>/videowall
```

Please note: VWCA stores its configuration information (like monitor settings, linked servers, etc.) on the server where it was started from. If you want to control more than 1 Observer servers with your VWCA, you have to start it always from the same server.

VWCA has the following components:

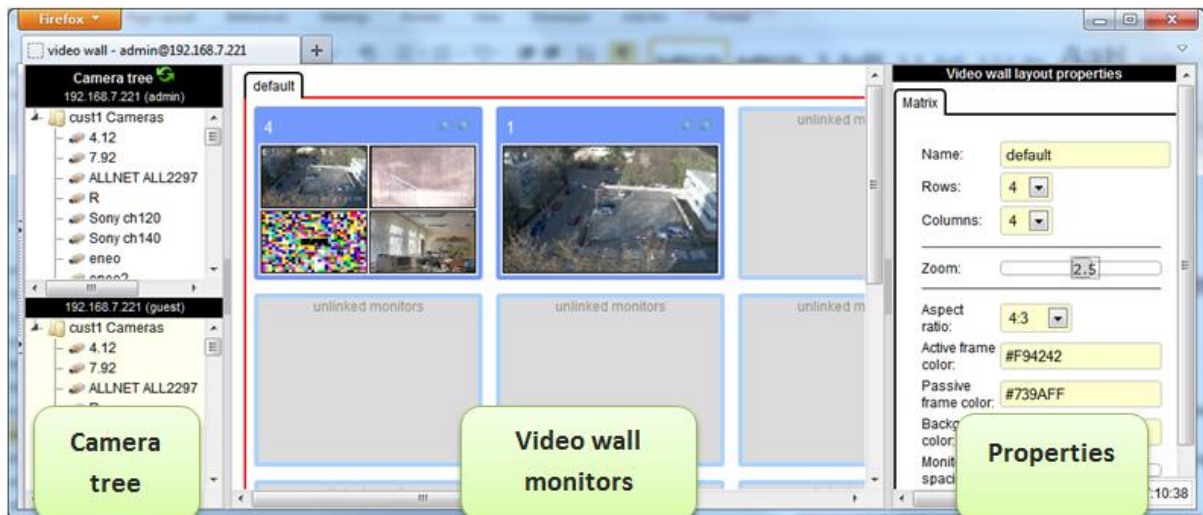

- Left side: Camera tree – separate for each server link.
- Middle: Video wall monitors – here you can control the contents of the video wall monitors
- Right side: Properties of the current selection – here you can see and modify the properties.

22.2.2 Configuring the video wall control application (VWCA)

Before you can control the video wall with the video wall control application you have to configure it. We assume that you have already set up your video wall physically and you have already configured the video wall client workstations/PCs that connect to the various monitors of your video wall (see 22.1 *Setting up a video wall with Observer* on page 188).

Configuring the basic setup

1. Select video wall matrix by clicking on the default tab or the background area between monitors. You will see the **Matrix** settings in the Properties pane.
2. Define the number of rows and columns of your video wall (this must obviously match your physical setup).
3. Select the appropriate aspect ratio of the monitors
4. The zoom factor defines how many monitor columns of your video wall you want to see in your VWCA without scrolling.
Additionally, you can also define some colors.

Linking the VWCA to servers

Before you can operate the video wall with VWCA you have to define the linking (mapping) between the physical monitors of the video wall and the monitors inside VWCA. The linking is actually done via the Observer server that serves the video wall client workstations that actually connect to the monitors and by choosing the appropriate Observer user login for which the windows for the monitors have been defined.

Here are the steps for linking VWCA to the video wall servers:

1. Select one of the monitors by clicking on it. You will see **Server link** in the Properties pane.
2. Enter the **server address**, **Login name** and **Password** of the Observer server that serves the video wall control workstations/PCs (for a general description on which servers and users to

choose please see *22.1 Setting up a video wall with Observer* on page 188). Please note that you have to select the correct user login for the monitor: You have to take the user login of the video wall client workstation/PC where the monitor is connected to.

3. Push **Validate**. If you entered the correct server and login combination you will be offered to choose from the available windows of the user.
4. Choose the window that is associated with the monitor (please remember that each monitor has an associated Observer window; for a basic explanation please refer to *22.1 Setting up a video wall with Observer* on page 188). You will notice that a view of the window has been selected by default.
5. Repeat the above steps for all monitors of the video wall.

22.2.3 Operating the video wall with the video wall control application (VWCA)

You have several possibilities for controlling the contents video wall monitors. When you select a monitor by clicking on the monitor title bar inside VWCA you can:

Select a view from the View list. Please note that each window in Observer can have several views.

Drag/drop a camera from the camera tree to a view port in a monitor. Please note that you drag a camera only to the view port of a monitor that also has the appropriate server link. Impossible camera drops are prohibited and are shown with a red cross.

Push the Back and Next buttons at the monitor title bars to move in history. You can also specifically select a point in the history by selecting it from the **History** tab in the Properties pane.

Please note that the status bar shows the camera name when you move the mouse pointer over monitor view ports.

23 Special functions

This chapter describes some special functions of Observer.

23.1 Video annotations

Video streams for live viewing and recording can be annotated with text that then displayed in the video stream. The annotations can come from external data sources and can be stored in the event database for later retrieval and search.

Annotations can be created via the SNAP XML interface or with a simple shell command with command line options.

Example applications are POS cash register data, ATM data, logistics data, or access control data.

23.1.1 Working with video annotations

You can access the video annotation tools from the server's web page:

1. At the server's web page click on **Customizer login** to login to the Customizer area (the admin password is needed for that).
2. After login click on **Download configuration files**.
3. Download the file **annotate.zip** and unpack the zip to a local directory on your client.
4. The zip contains the Windows command line program **annotate.exe**. Just run the program from a command line to see all options. You can also refer to `annotate-readme.txt`. (The Java source code of the program is also part of the zip file)
5. If you select to generate an event with the video annotation, an event will be stored in the event database for later retrieval and search. By selecting `VideoStreamAnnotation` in the event type filter of the **Event search** dialog, the annotation text can be searched for by SQL-type wildcards.

23.2 Embedding Observer video streams in web pages (Video4Web)

Observer 4.5 introduced Video4Web which replaced the previous Snaplet technology with a significantly more versatile solution for embedding cameras' live video streams in standard web pages.

Video4Web is a small embeddable JavaScript app which works on most desktop and mobile browsers. It provides the following functionalities:

- Plays back MJPEG stream or JPEG image series (browser-dependent)
- Plays single stream or users can select from the camera tree popup
- Full screen support, with image maximize effect fallback on older browsers
- Supports all major desktop and mobile browsers, back to Internet Explorer 6
- Easy-to-use: no JavaScript knowledge required to embed in HTML pages
- Small unobtrusive JavaScript app, doesn't interfere with other JS code

To see how to integrate Video4Web into your web pages please refer to the examples and full documentation available on the Observer server's web page (<http://<your-server-IP>>) under Documentation - Video4Web.

Please note: Currently Video4Web only supports MJPEG streams.

23.3 Controlling Observer with HTTP commands from external sources (URL control)

URL control is one way to enable third-party applications to start actions via URL-encoded strings (send http GET request to an Observer server). The server upon receiving these special URL requests executes the actions as if they would have been generated internally.

For testing purposes, you can execute URL control by entering an HTTP command in a standard web browser.

```
http://<your-server>/arms/servlet/BrowserServlet?cmd=clientcontrol& . . .
```

23.3.1 Available URL control parameters

Here is a list of available URL control parameters:

- **selector.tool**= name of the target tool in the client application (possible values: **online_monitor**, **archive_tool**)
- **selector.machine**= optional IP address of the target client PC
- **selector.user**= optional name of the logged-in target user (if both machine and user are specified then only the client application is selected which fulfills both conditions)

Further action parameters are:

- **action.action**= the action to be executed (possible values: **show_live_stream**, **show_calendar**, **play_archive**, **draw_bounding_box**)
- **action.cameraid**= ID of camera that is involved in the action
- **action.mode**= further descriptor for the action (possible values: **pop_if_exists**, **show_as_large**, **show_in_view**, **show_all_cams**)
- **action.fromtime**= from time stamp (YYYY-MM-DDTHH:MM:SS or millisecs since Unix epoch) of archive playback. Should be given only when action is **play_archive**.
- **action.totime**= to time stamp of playback (YYYY-MM-DDTHH:MM:SS or millisecs since Unix epoch). Should be given only when action is **play_archive**.
- **action.idlist**= comma separated list of camera ids which we want the archive playback or want to place them in the current Online monitor view . Should be given only when action is **show_live_stream** or **play_archive**.
- **action.panelname**= name of Online monitor view that should be exposed. Should be given only when mode is **show_in_view** or **show_all_cams**. Following conditions exist:
 - If **panelname** does not exist it will be created and all cameras listed in the **idlist** parameter will be placed into it.
 - If **panelname** exists with the cameras listed on the **idlist** parameter, it will be popped up.
 - If **panelname** exists but the **idlist** parameter contains more cameras as there already are in the view, then: 1) if we have enough view-ports to show the rest of the cameras it will

be shown there, or 2) if the view can not handle any more view-ports, a new view will be created where all listed cameras are then placed.

- **box.x0**= upper left x coordinate of box (valid between 0 and 1000). The values are in 1/10th percentages of the displayed image. Box parameters should be supplied only when the action is `draw_bounding_box`.
- **box.y0**= upper left y coordinate of box (valid between 0 and 1000)
- **box.x1**= lower right x coordinate of box (valid between 0 and 1000)
- **box.y1**= lower right y coordinate of box (valid between 0 and 1000)
- **box.linewidth**= line width used when drawing the box
- **box.color**= color of the box (possible values: black, blue, cyan, darkgray, gray, green, lightgray, magenta, orange, pink, red, white, yellow)
- **box.text**= text which is written into the box
- **box.timeout**= seconds after the box disappears automatically (0 mean click to disappear)

Please note: URL control is only enabled for allowed computers whose IP addresses are known to the server (see *11.2 Setting Observer server parameters* on page 109 for details). All other requests are blocked.

Please refer to the *Release Notes* for further details or updates on URL control.

23.3.2 URL control examples

Create an action that brings up images of camera ID 12 in a large view on a client machine where the "admin" user is logged in (we assume that the address of the server to which we are sending the URL control is 192.168.7.2):

```
http://192.168.7.2/arms/servlet/BrowserServlet?cmd=clientcontrol&selector.user=admin
&selector.tool=online_monitor&action.action=show_live_stream
&action.mode=show_as_large&action.cameraid=12
```

Create action which draws a red box (for two seconds) onto the frame of camera ID 12 in the Online Monitor of the "admin" user:

```
http://192.168.7.2/arms/servlet/BrowserServlet?cmd=clientcontrol&selector.user=admin
&selector.user=admin&selector.tool=online_monitor
&action.action=draw_bounding_box&box.x0=100&box.y0=100&box.x1=500&box.y1=500
&box.linewidth=2&box.color=red&box.text=MD&box.timeout=3&action.cameraid=12
```

Each server offers a simple test page for URL control at the following address:

`http://<your-server>/URLtest.jsp.`

23.4 Matrix View function of the Online Monitor (VIP control)

With the matrix view function (also called VIP control) you can control, which cameras defined in a bigger matrix are displayed in a view in the Online monitor.

For example, assume you have a big area covered with 50 cameras. Each of these 50 cameras cover a part of the overall area. The Matrix view function now allows you to position all the cameras in a huge virtual matrix covering the whole area:

Cam1	Cam2	Cam3	Cam4	Cam5	Cam6	Cam7	Cam8	Cam9	Cam10
Cam11	Cam12	Cam13	Cam14	Cam15	Cam16	Cam17	Cam18	Cam19	Cam20
Cam21	Cam22	Cam23	Cam24	Cam25	Cam26	Cam27	Cam28	Cam29	Cam30
Cam31	Cam32	Cam33	Cam34	Cam35	Cam36	Cam37	Cam38	Cam39	Cam40
Cam41	Cam42	Cam43	Cam44	Cam45	Cam46	Cam47	Cam48	Cam49	Cam50

Now assume that in the Observer Online monitor you want to show adjacent cameras of this virtual matrix in a 3x3 view . Whenever you double click any of the 50 cameras in any of the views in Observer this camera is then positioned as the center of the 3x3 view and the adjacent cameras of the big matrix are automatically positioned around it. In the example above you see how the 3x3 view would look like if you would double click Cam24 and Cam18.

The Matrix view function is defined by XML files sitting on the server. The name of the XML files follows the form **server.utils.CameraMatrixMapping.<action>.xml**. You start by downloading and editing the file **server.utils.CameraMatrixMapping.sample.xml**. When you are done with editing you upload the file under a specific name to the server.

23.4.1 Download the XML config file

You can access the XML file in a web browser from the server's web page:

1. At the server's web page click on **Customizer login** to login to the Customizer area (the admin password is needed for that).
2. In the Customizer click on **Download configuration files**.
3. In the list of files find and save **server.utils.CameraMatrixMapping.sample.xml** to your local hard disk. You can do that by right clicking on the file and then choosing **Save link as...** from the menu.

23.4.2 Edit the XML config file

Edit the file according to your needs. A detailed description about the function can be found in the comment at the beginning of the file. When you are done with editing save the file under a file name that reflects the trigger action for which you want to enable the Matrix view.

Possible trigger actions for the Matrix function and the corresponding XML file names are:

Trigger action	XML file name
double click in a camera view port	server.utils.CameraMatrixMapping.DOUBLE-CLICK.xml
single click in a camera view port	server.utils.CameraMatrixMapping.SINGLE-CLICK.xml

Trigger action	XML file name
LNT: single click, double click, mouse over or context menu on a camera icon	server.utils.CameraMatrixMapping.LNT.xml

In addition to the above you can also control on which Observer clients the Matrix view function should be triggered. You can do that by downloading and editing the file **server.utils.TargetActionMapping.sample.xml**.

23.4.3 Upload and activate the XML config files

You can upload and activate the Matrix function by following these steps:

1. At the server's web page click on **Customizer login** to login to the Customizer area (the admin password is needed for that).
2. In the Customizer under the heading **Upload configuration files** click on the button **Choose file**.
3. In the opened file dialog choose the file that you want to upload and push **Open**. Repeat this step for all files you want to upload.
4. Uploading a properly filled CameraMatrixMapping file to the server will activate the mapping function. No server restart is necessary, changes become active within 10 seconds after upload.

23.5 Holiday calendar

A holiday calendar allows you to define a list of special days (holidays) and to modify the standard recording schedules of cameras for these days (enable or disable recordings).

The holiday calendar is defined in an XML file that can be accessed via the standard server web page.

23.5.1 Download the XML config file

You can access the XML file in a web browser from the server's web page:

1. At the server's web page click on **Customizer login** to login to the Customizer area (the admin password is needed for that).
2. In the Customizer click on **Download configuration files**.
3. In the list of files find and save **HolidayCalendar.SAMPLE.xml** to your local hard disk. You can do that by right clicking on the file and then choosing **Save link as...** from the menu.

23.5.2 Edit the XML config file

Edit the file according to your needs. A detailed description about the function can be found in the comment at the beginning of the file. When you are done with editing, save the file.

The SAMPLE file has to be renamed to **HolidayCalendar.xml**.

Please note: The holiday calendar has to be configured on camera servers (NCS). Controlling recording over user servers (NUS) is not supported.

23.5.3 Upload and activate the XML config file

You can upload and activate the function by following these steps:

1. At the server's web page click on **Customizer login** to login to the Customizer area (the admin password is needed for that).
2. In the Customizer under the heading **Upload configuration files** click on the button **Choose file**.
3. In the opened file dialog choose the file **HolidayCalendar.xml** and upload it to the server.
4. Please restart Observer to activate settings of the holiday calendar.

23.6 Automatic export of event statistics

Note: Automatic exports configured in versions prior to Netavis Observer 4.7 via the XML configuration file (as described below) will continue to work in Observer 4.7. However if you also want to automatically upload these exports then you will need to remove the previous XML configuration and re-configure the setup in the Automatic Export tab (see *19 Automatic Export* on page 181 for details). From Netavis Observer 4.7 onwards using Automatic Export tab is the recommended way to automatically export and upload event statistics, events including their parameters, and heat maps to Netavis sMart Data Warehouse and other 3rd party systems. The description below is only included for legacy reasons.

Observer allows you to automatically export event statistics data in the format of a CSV (comma-separated text file) that can be easily read by programs like MS Excel. The details of the statistics like resolution, duration and filters for event types and camera can be flexibly defined.

The exported file will be stored in the file system of the server. This means you must have file system access to the server in order to obtain the file. You can do that, for example, via FTP and the admin user and password. Or you can mount a network drive (via Samba or NFS) and place the file there.

The statistics export function is defined by an XML file sitting on the server. You must download, edit, and then upload the file in order to configure and activate the function.

23.6.1 Download the XML config file

You can access the XML file in a web browser from the server's web page:

1. At the server's web page click on **Customizer login** to login to the Customizer area (the admin password is needed for that).
2. In the Customizer click on **Download configuration files**.
3. In the list of files find and save **StatisticExportConfig.ACTIVE.xml** to your local hard disk. You can do that by right clicking on the file and then choosing **Save link as...** from the menu. Please note: If there is no such file then download the **StatisticExportConfig.sample.xml**.

23.6.2 Edit the XML config file

Edit the file according to your needs. A detailed description about the function can be found in the comment at the beginning of the file. When you are done with editing save the file.

If you want to access the generated statistics files via FTP, we suggest that you create the output file in /home/admin. If you want to put the file on a mounted network drive then use the mount location.

The SAMPLE file has to be renamed to **StatisticExportConfig.ACTIVE.xml**.

23.6.3 Upload and activate the XML config file

You can upload and activate the function by following these steps:

1. At the server's web page click on **Customizer login** to login to the Customizer area (the admin password is needed for that).
2. In the Customizer under the heading **Upload configuration files** click on the button **Choose file**.
3. In the opened file dialog choose the file **StatisticExportConfig.ACTIVE.xml** and upload it to the server.
4. Please restart Observer to activate settings of the automatic event export.

23.7 Configuring I/O devices

Note: I/O devices (and their corresponding actions) configured in versions prior to NetavisObserver 4.6 via the XML configuration file (as described below) will continue to work in Observer 4.6. However if you want to use I/O devices with new features introduced in Observer 4.6 (e.g. Rule Administration or iCat Number Plate Recognition) then you will need to remove the previous XML configuration and re-add the I/O device in the I/O Device Administration (see *16 I/O Device Administration* on page 170 for details). From NetavisObserver 4.6 onwards using I/O Device Administration and Rule Administration is the recommended way to work with I/O devices and the description below is only included for legacy reasons.

Netavis Observer allows you to work with I/O contacts of cameras and special I/O devices.

The I/O device configuration is done by XML files sitting on the server. You must download, edit, and then upload the files in order to configure and activate the function.

23.7.1 Download the XML config files

You can access the XML file in a web browser from the server's web page:

1. At the server's web page click on **Customizer login** to login to the Customizer area (the admin password is needed for that).
2. In the Customizer click on **Download configuration files**.
3. In the list of files you find several XML files that are responsible for the device configuration:

XML file name	Description
server.externalIO.deviceio.DeviceMappings.xml	Actual I/O device configuration
server.externalIO.deviceio.DeviceTypeDescriptor.<device_type>.xml	Device descriptor files (not intended for modification by you)

Save **server.externalIO.deviceio.DeviceMappings.xml** to your local hard disk. You can do that by right clicking on the file and then choosing **Save link as...** from the menu.

Please note: If there is no such file then download the **server.externalIO.deviceio.DeviceMappings.sample.xml**.

23.7.2 Edit the XML config files

Edit the file `server.externalIO.deviceio.DeviceMappings.xml` to your needs. A detailed description about the function can be found in the comment at the beginning of the file.

For each supported I/O device types there is a device descriptor file `server.externalIO.deviceio.DeviceTypeDescriptor.<device_type>.xml`. For configuring a device you must refer to one of the supported devices in `server.externalIO.deviceio.DeviceMappings.xml`.

When you are done with editing, save the file.

Please note: The sample file has to be renamed to **server.externalIO.deviceio.DeviceMappings.xml**.

23.7.3 Upload and activate the XML config files

You can upload and activate the function by following these steps:

1. At the server's web page click on **Customizer login** to login to the Customizer area (the admin password is needed for that).
2. In the Customizer under the heading **Upload configuration files** click on the button **Choose file**.
3. In the opened file dialog choose the file `server.externalIO.deviceio.DeviceMappings.xml` and upload it to the server.
4. Please restart Observer to activate the configuration.

Hint: For more details on configuring I/O devices please refer to the *I/O Contacts* White Paper available in the [documentation section](#) of our [website](#).

23.8 AXIS T8310 Control Board configuration

Observer 4.5 added support for the AXIS T8310 Video Surveillance Control Board which consists of a joystick, keypad, and jog dial. These input devices can be used individually or combined.

Note: Joystick-support is only available in the locally installed Observer client on Microsoft Windows platforms!

23.8.1 Installation

Follow these steps to enable AXIS T8310 Control Board support on a client:

- Connect the AXIS T8310 Control Board to the system and wait for Windows to detect and install it
- Install the latest Observer client via the corresponding option from the **Observer Start page**
- Restart the client computer to complete the installation process

23.8.2 Use

The following two figures show the controls and buttons of the AXIS T8312 keypad and AXIS T8313 jog dial. For simplicity we have numbered the buttons for later reference.

AXIS T8312 keypad:

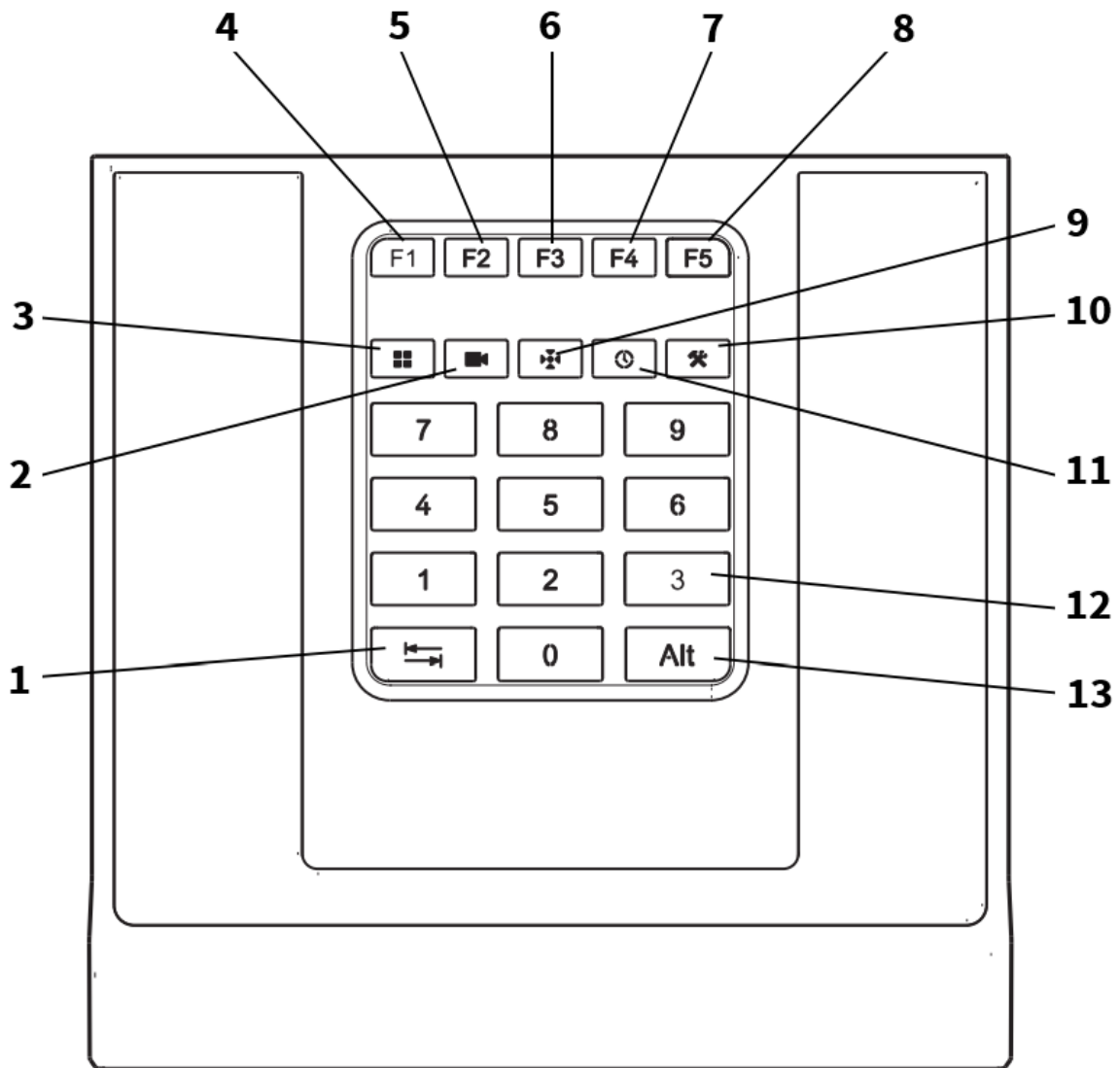

AXIS T8313 jog dial:

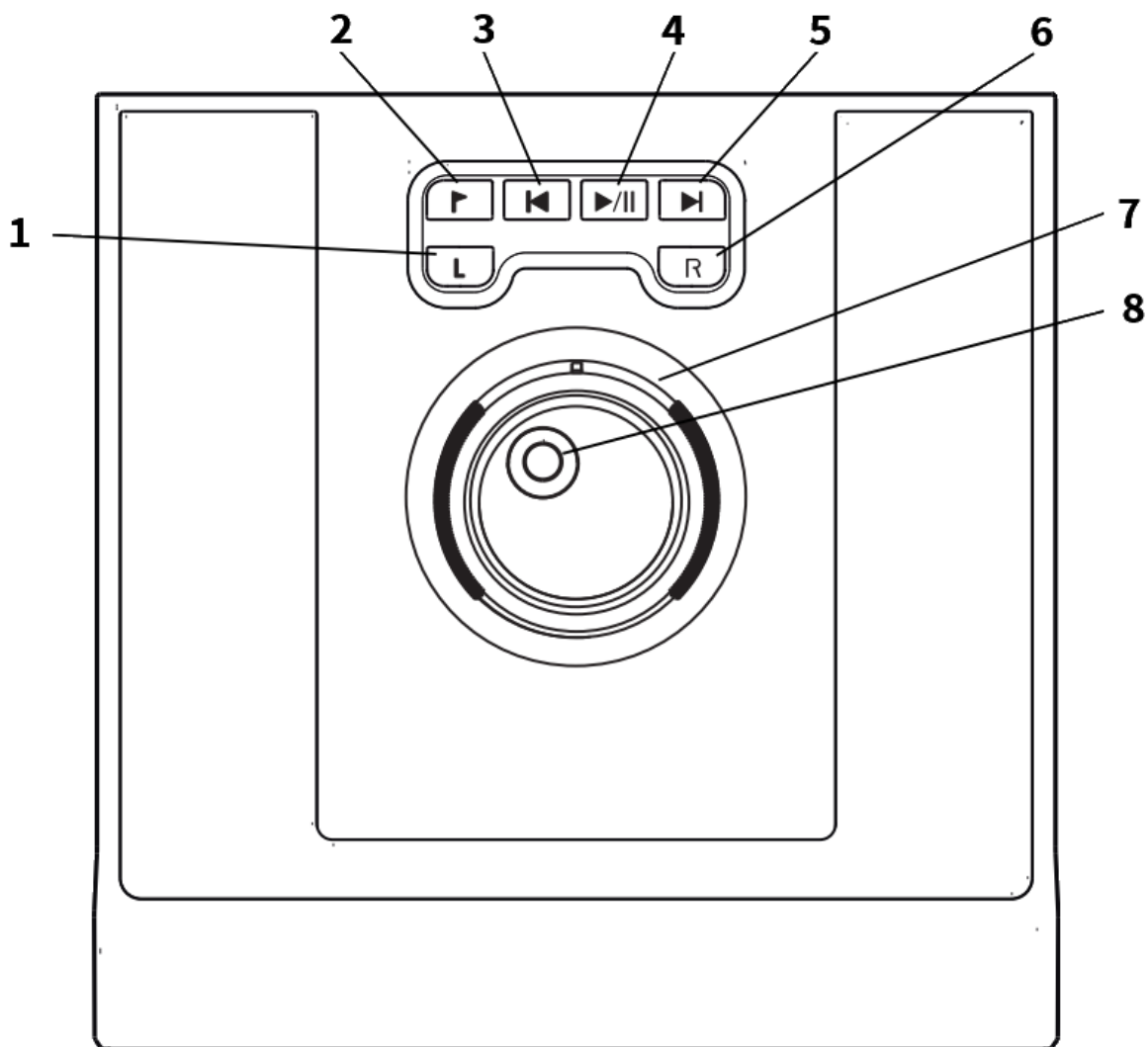

The functions assigned to the different buttons of the keyboards are dependent on whether the Online Monitor or Archive are in focus. To show the current focus press the **Alt (13) + View (3)** button combination. The focus between windows and between different tabs within windows can be changed forward with the **Tab (1) button** and backward with the **Alt (13) + Tab (1)** button combination.

Below you will find a list with the assignment of the buttons in the Online Monitor and Archive:

- **Online Monitor:**

AXIS T8312 keypad

1 - Tab: Move focus forward, or combined with **Alt (13)** backward

2 - Camera: After entering numbers and pressing this button the camera whose name ends with an underscore (_) character followed by the entered number (e.g. Camera_212) is activated. In case no such camera exists an „Invalid camera: XXX” message is shown

3 - View: After entering numbers and pressing this button the view whose name starts with the entered number followed by an underscore (_) character (e.g. 123_MainView) is shown. In case no such view exists an „Invalid view: XXX” message is shown

4 - Activate view: Activates the first view which contains the previously assigned camera

5 - Activate large view: The previously assigned camera is shown in a large view

6 - Show previous view

7 - Show next view

8 - Not used

9 - Activate PTZ: In case the last assigned camera has PTZ capabilities, this button activates the PTZ function and the AXIS T8311 joystick will be assigned to this camera

11 - Archive: Displays the archive view of the previously assigned camera

10 - Administration: Displays the administration view of the previously assigned camera

12 - Numbers: For entering digits in camera names or view names

AXIS T8313 jog dial

1-6: Not used

7 - Previous/Next view: Changes to the previous or next view

8 - Select view: The names of defined views appear on the screen upon turning the jog wheel. To change to the given view press the **View (3)** button within 3 seconds.

- **Archive player:**

AXIS T8313 keypad

Not used

AXIS T8313 jog dial

1 - Not used

2 - Marker button: Valid only when followed by pressing the **Left (1)** or **Right (6)** buttons. When you press the **Left (1)** button then the start (left) marker of the interval is positioned under the current position of the playback marker. Pressing the **Right (6)** button will modify the end time stamp. When the **Play (4)** button is pressed the video sequence for the new time interval will be downloaded and played back.

4 - Play/Stop

3,5 - Jump to the Beginning or End of the selected time interval

7 - Not used

8 - Move playback marker back and forth in the sample line

- **Examples:**

00123 (2) - Select the camera, whose name ends with „_00123”

11 (3) - Select the view, whose name starts with „11_”

23.9 SNMP Support (Simple Network Management Protocol)

In Netavis Observer 4.5 SNMP support in Observer was enhanced so a broad variety of operating system and application events can be communicated to monitoring systems. Thereby failures such as

camera malfunctions can be detected and addressed even faster. Also events such as iCat detections can be forwarded accordingly.

Note: As of Netavis Observer 4.7 SNMP support is included in the standard license.

23.9.1 Configuration

1. At the server's web page click on **Customizer login** to log into the Customizer area with the administration user **admin**.
2. After login click on **Download configuration files**.
3. Download the file **server.site.snmp.SNMPMappings.sample.xml**.

Note: Here you can also download the file **NETAVIS-MIB.txt** which contains the NETAVIS MIB (Management Information Base).

4. Edit the sample file according to the desired configuration:

```
<SNMPMappings Enabled="true">
  <USMUser SecurityName="name" AuthProtocol="SHA" AuthPass="password" PrivProtocol="AES" PrivPass="password"/>
  <Community Name="public"/>
  <VACM EnableV1="true"/>
  <Transport Port="10020"/>
  <Notification V2cIP="10.10.10.18" V3IP="10.10.10.18"/>
</SNMPMappings>
```

Element	Description	Version	Options
SNMPMappings	Root element		
- Enabled	"true" to enable / "false" to disable the SNMP configuration	SNMPv1/2/3	
USMUser	Required for authentication		
- SecurityName	Security name used for generating SNMP notifications.	SNMPv3	
- AuthProtocol	Authentication method	SNMPv3	SHA, MD5
- AuthPass	Authentication password (minimum 8 characters, also has to be filled in when SNMPv3 is not used)	SNMPv3	
- PrivProtocol (Optional)	Encryption standard	SNMPv3	AES, DES
- PrivPass (Optional)	(minimum 8 characters, also has to be filled in when SNMPv3 is not used)	SNMPv3	
Community	SNMP community		
- Name	Name of the community	SNMPv1/2/3	
VACM	SNMPv1 can be deactivated on demand		
- EnableV1	"true" to enable / "false" to disable SNMPv1	SNMPv1	
Transport	SNMP data		

Element	Description	Version	Options
- Port	Standard port of Netavis Observer for SNMP data	SNMPv1/2/3	
Notification	Notification options for SNMPv2/3		
- V2cIP	IP address of the SNMP management station for the corresponding version	SNMPv2	
- V3IP	IP address of the SNMP management station for the corresponding version	SNMPv3	

23.9.2 Activation

Once the configuration file has been adapted, rename it to `server.site.snmp.SNMPMappings.default.xml` and upload it via the **Customizer login**. Afterwards the Observer server or at least the NETAVIS services have to be restarted for the SNMP agent to be activated.

To receive the SNMP data sent by Observer a so-called SNMP management station software is needed.

23.9.3 Available system information and Observer events

The following system information and Observer events are available via SNMP:

System information (available with SNMP Get / Walk via the NETAVIS-MIB):

NETAVIS-MIB Name	Description
Host Table Entry	
o2HostID	Unique identifier of the server.
o2HostName	Human readable name of the server.
o2HostOSNameAndVersion	Name and version of the Operating System running on the server.
o2HostCPUIdle	Percent of CPU idle time (the higher this value means the less work the CPU is doing).
o2HostTotalMemory	Size of the RAM in kBytes.
o2HostUsedMemory	Total number of RAM kBytes in use.
o2HostTotalSwap	Number of configured kBytes of swap space.
o2HostUsedSwap	Number of used kBytes of swap space.
o2HostUptime	The time (in UNIX seconds) since the NETAVIS server has been booted.
Storage Table Entry	
o2StorageHostID	Unique identifier of the server where this disk is connected to.
o2StorageID	Identifier which is valid only locally on the server.
o2StoragePath	For internal storage types it shows the device path of the partition where the storage is located (e.g. /dev/sda1). For external storage

NETAVIS-MIB Name	Description
	types it shows the mount point or directory where the external device has been mounted.
o2StorageTotal	Total number of MBytes.
o2StorageUsed	Total number of used MBytes.
o2StorageStatus	Accessibility information.
o2StorageType	A storage can be attached to a server locally as a disk device or externally via SAN, NAS or any type of network mount (e.g. NFS).
Video Platform	
o2VPID	Unique identifier of the host within a distributed network.
o2VPName	Internal name of the video platform within the domain of servers.
o2VPVersion	Software version of the video platform.
o2VPLicense	Overall license information.
o2VPStorageUtilization	A percentage value telling how much of the available image archive has been filled up with images.
o2VPUptime	The time (in UNIX seconds) since the NETAVIS video platform has been started.
User Table Entry	
o2UserName	Login name of user.
o2UserLoginStamp	Unix stamp when the user has logged in.
o2UserClientAddress	Address of the login terminal.
o2UserClientVersion	Version number of the client software.
o2UserSessionType	The type of the connection via the user is connected to a server.
Camera Table Entry	
o2CameraID	Unique identifier of the camera.
o2CameraHostID	Identifier of the host where this camera is connected to.
o2CameraName	Name of the camera.
o2CameraType	Vendor and type of the camera.
o2CameraAddress	Address of the camera.
o2CameraStatus	Aggregated status information.
o2CameraLastErrorStamp	Unix time stamp of the last error.
o2CameraLastErrorMessage	Message from the camera or network for the last error event.
o2CameraRecording	Shows if a recording is scheduled to run on the camera at this point in time.
o2CameraVideoAnalytics	Shows if an iCat definition is scheduled to run on the camera at this point in time.
o2CameraRequestedRecordingTime	Length of the camera archive in hours.
o2CameraArchiveLoadPerc	Percentage telling how much of the image archive is filled up with images.
Event Descriptor	

NETAVIS-MIB Name	Description
o2EventName	Short name of the event (i.e. name of concrete container class).
o2EventNumber	Netavis-internal unique identifier of the event.
o2EventStamp	Time stamp when the event has happened in seconds.
o2EventCameraID	Netavis-internal unique identifier of the camera (if event is not camera specific its value is zero).
o2EventCameraName	Name of the camera (can be empty if event is not camera specific).
o2EventUserID	Netavis-internal unique identifier of the user (only if event is user related, in other cases its value is zero).
o2EventUserName	Name of the user if event is user specific, otherwise empty.
o2EventDescription	Human-readable representation of the event.

Observer events (available with SNMP Trap):

Observer Event	Description
AgeGenderDetection	Event generated when a face with age and gender estimation is detected.
ArchiveAccess	Event generated when archive is accessed.
BaseDataChange	Event generated when configuration data (system, users, cameras, iCat definitions, etc.) is changed.
CameraAuthenticationFailure	Event generated when a camera can't be accessed due to a wrong user / password configuration.
CameraIOStateChange	Event generated when a camera's I/O contacts are changed.
CameraPTZChange	Event generated when a camera's PTZ position changes.
ConnectionLostToHost	Event generated when the connection to the host is lost.
ConnectionRestoredToHost	Event generated when the connection to the host is restored.
ConnectionToCameraLost	Event generated when the connection to a camera is lost.
ConnectionToCameraRestored	Event generated when the connection to a camera is restored.
CustomEvent	Event generated when a CustomEvent occurs.
DegradedImageSaving	Event generated when the recordings are degraded.
DiskSubsystemFailure	Event generated when a hard drive has failed.
FaceDetection	Event generated when a face is detected.
GUIControlChange	Event generated when changes are made to the client's interface.
ImageExportEvent	Event generated when archive recordings are exported.
InCameraDetection	Event generated when an in-camera motion detection occurs.
InverseTrafficEvent	Event generated when Wrong Way Traffic is detected.
MotionDetection	Event generated when a motion detection occurs.
PlateNumberRecognition	Event generated when a number plate is detected.
RecordingSwitchedOff	Event generated when a recording is stopped.
RecordingSwitchedOn	Event generated when a recording is started.

Observer Event	Description
SMSSendError	Event generated when an SMS notification can't be send.
StoppedVehicleEvent	Event generated when a Stopped Vehicle is detected.
TrafficStateChange	Event generated when a Traffic State change is detected.
UserEventACK	Event generated when a user acknowledges an event.
UserLoggedIn	Event generated when a user logs in.
UserLoggedOut	Event generated when a user logs out.
VideoContentAlert	Event generated when an iCat Object Tracking detection occurs.
VideoSignalLost	Event generated when the video signal from a camera is lost.
VideoStreamAnnotation	Event generated when a video stream annotation occurs.

24 Index

4

4CIF 10

A

ABS transcoding for low-bandwidth connections 27

 configuring ABS 112

Acknowledging events 93

Active Directory 53, 124

AES encryption of video recordings 113

Alarms see Events 98

Annotating videos with data from external sources 193

Apple iPad 21

Apple iPhone 21

Archive See Recording

Aspect ratio

 of JPEG images 10, 34

 of Online monitor views 54

 PAL, NTSC, VGA, HDTV 54

Audio

 playback in archive 78

 working with cams 64

AVI

 exporting from archive 80

B

Bandwidth

 limiting overall outgoing bandwidth of server 113

 support for low bandwidth via Transcoding 27

C

Calendar in archive 73

Camera

 access rights for users 50

 duplicate existing camera with similar settings 40

 dynamic privacy mask 163

 groups 42

 moving in camera tree 43

 port mapping on video server 43

 privacy mask 157

 sabotage detection 153

 setup 31

 status 41

 status display (LNT) 140

 video analytics (iCat) 142

Camera server (NCS) 117

Camera tree

 drag and drop cameras 55

 how to work with it 55

 positioning in the window 17

CIF 10

Client

 installation directory for client components 15

 introduction 11

 locally installed 12

 multi-window/multi-screen operation 17

 overview of components 20

 preferences 19, 20

 starting 12

 support for low-bandwidth connections 27

Clone camera 40

CPU load

 and streaming formats 8

 display of server CPU load 107

 for video analytics (iCat) 145

Cropped view ports

 define which part to display 59

D

Data integration with external applications
193

Data security 7

Deleting windows 18

Demo mode license 11

Distributed upgrades of servers 122

DivX exporting from recordings 80

Documentation set 6

Drag and drop

camera from the camera tree to view ports
55

Duplicate existing camera 40

Dynamic privacy mask (iCat) 163

Dynamic views (view ports) 64

E

Email

receiving on events and alarms 98

Encryption

AES encryption of video recordings 113

general description 7

HTTPS for camera connections 34

HTTPS for client connections 12

HTTPS for server-server connections 119

Event triggers (iCat) 144, 150

Events 92

acknowledging 93

automatic export of statistics data 198

details 93

Event list 92

create a separate Event list window 17

maximizing 17

modifying layouts 17

positioning in the window 17

priorities 92

sorting 92

exporting event-related recordings 96

HTML export 96

in layout navigation 139

notification via client GUI, email, SMS 98

priorities 92

remote servers 121

searching in the event database 94

short replay 93

statistics 97

statistics data automatic export 198

user privileges for accessing and handling 92

video analysis (iCat) 169

Exiting the client 28

Export of event statistics data 198

Exporting archive recordings 79

event-related 96

External applications

control via HTTP commands 194

external archive, see NEA 83

F

Floating window components 17

Four-eyes principle 44

Four-eyes-principle 46

G

Getting started 29

H

H.264 7, See also MPEG

HDTV 16/9

aspect ratio in Online monitor 54

Heat maps

iCat Heat maps 166

Heat maps (iCat) 166

Holiday calendar 197

HTML code for embedding streams in web
pages 193

HTTP commands for starting actions 194

HTTPS encryption

between servers 119

- for camera connection 34
- for client connection 12
- general description 7

I

I/O contacts

- configuring I/O devices 199
- placing them on LNT layouts 131

I/O devices

- configuring 199

iCat 142

- considerations for setting up 144
- CPU load 145
- dynamic privacy mask 163
- event triggers 144, 150
- events 169
- Heat maps 166
- object bounding boxes 166
- object counting 150
- object markers 165
- object tracking region 144, 147
- people counting 150
- privacy mask 157
- sabotage detection 153
- SAFE export 81
- sensitivity setting 148
- Smart Tripwire(tm) 150
- starting and stopping objects 152
- video processing speed 145
- video streaming formats 144
- working with in Online monitor 165

In-camera motion detection 89

IP address

- of camera 33

iPad 21

iPhone 21

J

Joystick

- AXIS T8310 Control Board configuration 200

Joystick control for PTZ cameras 104

JPEG

- aspect ratio 10, 34
- exporting from archive 79
- image sizes and quality 10
- MJPEG vs. MPEG 7

L

Layout navigation 128

- editing mode 129
- I/O contacts 131
- installation 128
- navigation and operation 138
- zones 132

Layout of windows

- modifying 17

LDAP 53, 124

License

- displaying current license 108
- license string 11

Login

- secondary password 44
- the locally installed client 12

Low-bandwidth connections with Transcoding 27

M

Manual recording control in the Online monitor 59

Matrix View function (VIP control) 195

MJPEG 8

- versus MPEG streaming 9

Mobile devices, PDAs 21

Monitoring 203

Motion detection 86

- in archive 81
- in-camera 89
- server-based 86

Motion JPEG 8

MPEG 7, 8

- versus MJPEG streaming 9

- working with cams 64
- MPEG-4 7, See also MPEG
- Multi streaming (parallel video streams) 8
- Multi-screen operation 17
 - positioning windows 18
- Multi-window operation 17
- MxPEG 7, See also MPEG

N

- NCS camera server 117
- NEA external archive
 - accessing archives at another server 85
 - Displaying status 84
 - recording on removable storage devices 83
 - starting and stopping double recording 85
- NETAVIS_DIRECTORY environment variable for installed client components 15
- New system setup 29
- Notification on events and alarms 98
- NTSC 10
- NUS user server 117

O

- Object bounding boxes (iCat) 166
- Object counting (iCat) 150
- Object markers (iCat) 165
- Object tracking region 144
- Online monitor 54
 - Archive Access 64
 - creating views 54
 - defining views for new user 52
 - dynamic control with the Matrix function (VIP control) 195
 - manual recording control 59
 - navigating in the 56
 - view settings 57
 - working with iCat 165
 - zooming in a view port 59, 76
- Online Monitor

- dynamic control with iCat and motion detection 64

- Overlay painting 16

P

- PAL 10
- pan, tilt, zoom 100
- Password
 - changing 53
- PDAs (mobile devices) 21
- People counting (iCat) 150
- Playback of archive recordings 73
- Port mapping
 - of analog cameras on video server 43
- Preferences of the client 20
- Priority
 - of events 92
 - sorting event list 92
- Privacy mask (iCat) 157
- Privileges of users 47
- Protect archive recordings against deletion 79
- PTZ (pan/tilt/zoom) 100
 - automatic routes 105
 - control with motion detection 88
 - controlling camera 101
 - joystick control 104
 - routes 100
 - user priority 46

Q

- QCIF 10
- Quitting the client 28

R

- Recording 72
 - AES encryption of video recordings 113
 - Audio playback 78
 - calendar 73

- DivX export 80
- exporting 79
- exporting event-related recordings 96
- holiday calendar 197
- manual recording control in the Online monitor 59
- motion detection in 81
- on removable storage devices, see NEA 83
- Playback 73
- programming 72
- protection against deletion 79, 114
- SAFE format export 80
- storage management 72
- synchronous playback of mutiple cameras 78
- time zooming 77
- Release notes 6
- Remote servers
 - events 121
 - monitoring 121
 - upgrading 122
- Restarting and rebooting 109
- Round tours 61
- RTSP streaming port 113

S

- Sabotage detection (iCat) 153
- SAFE format archive export 80
- SAFE Player
 - iCat information 81
 - Playback 81
 - Zooming 81
- Screen resolution
 - minimum for running the client 11
- Secondary password
 - for login 44
- Security 7
- Sensitivity setting (iCat) 148
- Server
 - administrating 107
 - information about running servers 107

- load display 107
- network
 - camera server (NCS) 117
 - user server (NUS) 117
 - setting parameters 109
- Setup of a new system 29
- Smart guard function 61
- Smart Tripwire (iCat) 150
- Smartphones (mobile devices) 21
- SMS
 - receiving on events and alarms 98
- Snapplet, embedding live video streams in web pages 193
- SNMP 203
- Statistics
 - events 97
- Storage management in archive 72
- Streaming formats 7
 - iCat video analytics 144
- Synchronous playback of mutiple cameras in archive 78

T

- Time zone of server 110
- Time zooming in archive 77
- Transcoding for low-bandwidth connections 27
 - setting up 112
- Tripwire for object counting (iCat) 150

U

- Upgrading
 - remote servers 122
- URL control
 - allowed IP addresses 112
 - control from external applications 194
- User server (NUS) 117
- Users

- Active Directory/LDAP 53, 124
- adding 44
- camera access rights 50
- copying view between 62
- Four-eyes-principle 46
- groups 52
- info about logged in 52
- managing 44
- privileges 47

V

- VGA 10
- Video analytics 142, See iCat
- video annotations 193
- Video compression 7
 - MPEG vs. MJPEG 7
 - Transcoding for low bandwidth connections 27
- Video walls 188
 - configuring the control application 191
 - controlling with Observer 190
 - operating with the control application 192
 - setup 188
- View ports
 - creating 54
 - define crop view 59
 - dynamic event-based control 64

- zooming camera views 59, 76

Views

- copying between users 62
- dynamic event-based control 64
- Online monitor 54
- optimizing big views after double click 57
- round tours 61
- settings 57

- VIP control (matrix view function) 195

- VWCA (video wall control application) 190

W

Web pages

- embedding live video streams 193

Windows

- create a separate Event list window 17
- deleting 18
- modifying layouts 17

Z

- Zones in layout navigation (LNT) 132

Zooming

- in an Online monitor view port 59, 76
- in SAFE exports 81
- of PTZ cameras 103