



USER MANUAL

FOR NETWORK VIDEO RECORDERS

Version 4.04

w w w . v n s e c . u s



Legal Notice

Trademark Statement:

VGA is trademark of IBM Corporation.

The Windows logo and Windows are trademarks or registered trademarks of Microsoft Corporation.

Other trademarks or company names that may be mentioned in this document are the property of their respective owners.

Responsibility statement:

To the extent permitted by applicable law, in no event shall the Company compensate for any special, incidental, consequential, or consequential damages resulting from the contents of the documentation and the products described, nor any Compensation for loss of profits, data, goodwill, loss of documentation or expected savings.

The products described in this document are provided "as it is at present", except as required by applicable law, the company does not provide any warranty or implied warranties, including but not limited to, merchantability, quality satisfaction, and fitness for a particular purpose, does not infringe the rights of third parties and other guarantees.

Privacy Protection Reminder:

If you have installed our products, and you may be collected personal information such as faces, fingerprints, license plates, emails, telephones, and GPS. In the process of using the product, you need to comply with the privacy protection laws and regulations of your region or country to protect the legitimate rights and interests of others. For example, provide clear and visible signs, inform the relevant rights holders of the existence of video surveillance areas, and provide corresponding contact information.

About This Document:

- This document is for use with multiple models. The appearance and function of the products are subject to the actual products.
- Any loss caused by failure to follow the instructions in this document is the responsibility of the user.

- This document will be updated in real time according to the laws and regulations of the relevant region. For details, please refer to the product's paper, electronic CD, QR code or official website. If the paper and electronic files are inconsistent, please refer to the electronic file as.
- The company reserves the right to modify any information in this document at any time.
- The revised content will be added to the new version of this document without prior notice.
- This document may contain technical inaccuracies, or inconsistencies with product features and operations, or typographical errors, which are subject to the company's final interpretation.
- If the obtained PDF document cannot be opened, please use the latest version or the most mainstream reading tool.

Network Security Advice

Required measures to ensure basic network security of equipment:

Modify the factory default password and use a strong password

Devices that do not change the factory default password or use a weak password are the easiest to be hacked. Users are advised to modify the default password and use strong passwords whenever possible (minimum of 6 characters, including uppercase, lowercase, number, and symbol).

Update firmware

According to the standard operating specifications of the technology industry, the firmware of NVR, DVR and IP cameras should be updated to the latest version to ensure the latest features and security of the device.

The following recommendations can enhance your device's network security:

1. Change your password regularly

Regularly modifying the login credentials ensures that authorized users can log in to the device.

2. Modify the default HTTP and data ports

Modify the device's default HTTP and data ports, which are used for remote communication and video browsing.

These two ports can be set to any number between 1025 and 65535. Changing the default port reduces the risk of the intruder guessing which port you are using.

3. Use HTTPS/SSL encryption

Set up an SSL certificate to enable HTTPS encrypted transmission. The information transmission between the front-end device and the recording device is fully encrypted.

4. Enable IP filtering

After IP filtering is enabled, only devices with the specified IP address can access the system.

5. Change the ONVIF password

Some old versions of the IP camera firmware, after the system's master password is changed, the ONVIF password will not be automatically changed. You must update the camera's firmware or manually update the ONVIF password.

6. Only forward the ports that must be used

Forward only the network ports that must be used. Avoid forwarding a long port area. Do not set the device's IP to DMZ.

If the camera is connected locally to the NVR, you do not need to forward the port for each camera. Only the ports of the NVR need to be forwarded.

7. Use a different username and password on the video surveillance system.

In the unlikely event that your social media account, bank, email, etc. account information is leaked, the person who obtained the account information will not be able to invade your video surveillance system.

8. Restrict the permissions of the ordinary account

If your system is serving multiple users, make sure that each user has permission to access only its permissions.

UPNP

When the UPnP protocol is enabled, the router will automatically map the intranet ports.

Functionally, this is user-friendly, but it causes the system to automatically forward the data of the corresponding port, causing the data that should be restricted to be stolen by others.

If you have manually opened HTTP and TCP port mappings on your router, we strongly recommend that you turn this feature off. In actual usage scenarios, we strongly recommend that you do not turn this feature on.

SNMP

If you do not use the SNMP, we strongly recommend that you turn it off. The SNMP function is limited to temporary use for testing purposes.

Multicast

Multicast technology is suitable for the technical means of transmitting video data in multiple video storage devices. There have been no known vulnerabilities involving multicast technology

so far, but if you are not using this feature, we recommend that you turn off multicast playback on your network.

12. Check logs

If you want to know if your device is secure, you can check the logs to find some unusual access operations. The device log will tell you which IP address you have tried to log in or what the user has done.

Physically protect your device

For the safety of your device, we strongly recommend that you physically protect your device from unauthorized boring operations. We recommend that you place the device in a locked room and place it in a locked cabinet with a locked box.

It is highly recommended that you use PoE to connect IP cameras to NVR.

IP cameras connected to the NVR using PoE will be isolated from other networks so that they cannot be accessed directly.

Network isolation between NVR and IP cameras

We recommend isolating your NVR and IP cameras from your computer network. This will protect unauthorized users on your computer network from having access to these devices.

About This Document

Purpose

This document describes in detail the installation, use, and interface operations of the NVR (Network Video Recorder) device.

Modify Log

ID	Version	Log	Release Time
1	V 4.0	Initial Release	2017/
2	V 4.1	Add function	
3	V 4.1.3	Perfect interface, add models	
4	V 4.1.5	Add reverse playback Open data port 2	20180106
5	V 4.1.6	Add 4 split screens of automatic adjusting main stream or sub stream. Add private protocol access. Support multi-screen playback. Add the schedule recording function by channel setting Increase the allocation of permissions by channel	
	V 4.2	Add boot wizard Add toolbar Add manual recording and timely playback Add multiple clicks to enlarge Add user lockout Remove the upper right corner to display the	



		<p>alarm warning</p> <p>Add the view of the latest alarm information, modify the manual alarm</p> <p>Modify quick navigation content</p> <p>Preview channel and modify network parameter function on IPC side</p> <p>Support for copying to some or all channels</p> <p>Remove the full screen function</p> <p>Add background backup</p> <p>Add video dual authentication</p> <p>Intelligent motion detection</p> <p>Add the color to distinguish the video type, increase the video type search</p> <p>Add sound switch</p> <p>Add instant playback</p> <p>Remove the timeline function</p> <p>Increase intelligence analysis</p> <p>Increase test DDNS function</p> <p>Increase test mail function</p> <p>Modify the time precision to half an hour, remove the recording plan master switch</p> <p>Add hardware information</p> <p>Added video dual authentication and boot wizard configuration function</p> <p>Add alarm log</p> <p>Add interval update profile</p>	
6	V 4.2.1	<p>Add the NTP synchronization interval and add the manual NTP synchronization interval.</p> <p>Add access to thermal imaging cameras and display IPC product models</p> <p>Remove auto hide</p> <p>Add the patrol route and line sweep function</p> <p>Add upgrade IPC, restart IPC, restore factory IPC</p> <p>Increase the selection of primary and sub</p>	



		<p>stream backups</p> <p>Add click playback button to play video</p> <p>Add UI display granular IPC intelligence analysis</p> <p>Add 802.1x functionality</p> <p>Add SNMP function</p> <p>Add upgrade device features</p> <p>Add the timing restart function</p> <p>Add U disk upgrade display progress bar</p>	
7	V 4.2.4	<p>Increase U-boot and kernel version display</p> <p>Increase P2P status display</p> <p>Increase signal type display</p> <p>Increase POE icon display</p> <p>Increase SSL access IPC, special models support</p> <p>Optimize username and password saving methods</p> <p>Increase batch backup</p> <p>Increase fixed point playback</p> <p>Increase hard disk alarm</p> <p>Optimized recording expiration time input mode is editable</p> <p>Increase the city after each time zone</p> <p>Increase face recognition</p> <p>Add P2P server</p>	
8	V 4.3	<p>Add pattern unlock</p> <p>Add mailbox reset password</p> <p>Increase the secure question reset password</p> <p>Add 1+7 split screen</p> <p>Add channel information display</p> <p>Add 3D ball machine</p> <p>Remove the video type switch from the scene</p> <p>Add RAID</p> <p>Add S.M.A.R.T</p>	

		<p>Add formatting (fat32 and NTFS)</p> <p>Support event video quick download backup</p> <p>Add event video backup</p> <p>Add the full screen of the bomb and send the screenshot</p> <p>Add IPC intelligent analysis configuration</p> <p>Add manual input automatic logout time</p> <p>Restore factory refinement</p>	
9	V4.4	<p>Support adding POE cameras automatically or manually.</p> <p>Support 3G/4G modem provide Internet service.</p> <p>Support cloud storage.</p> <p>Add disk detection, disk group and multi channels recording.</p> <p>Support license plate recognition management.</p> <p>Support through RTSP to add cameras.</p> <p>Add thermal and face detection functions.</p> <p>Add IP conflict and internet disconnected alarm.</p>	

Symbol Conventions

The symbols may be found in this document, which are defined as follows:

Symbol	Description
 DANGER	Alerts you to a high risk hazard that could, if not avoided.
 WARNING	Alerts you to a medium or low risk hazard that could, if not avoided, result in moderate or minor injury.
 CAUTION	Alerts you to a potentially hazardous situation that could, if not avoided, result in equipment damage, data loss, performance deterioration, or unanticipated results.

Symbol	Description
 TIP	Provides a tip that may help you solve a problem or save time.
 NOTE	Provides additional information to emphasize or supplement important points in the main text.

Safety instructions

The following are the correct use of the product. In order to prevent danger and prevent property damage, please read this manual carefully before using the device and strictly comply that when using it. Please save the manual after reading.

Requirements

- The front-end devices of POE are required to be installed indoors.
- The NVR device does not support wall mounting.
- Do not place and install the device in direct sunlight or near heat-generating equipment.
- Do not install the device in a place subject to high humidity, dust or soot.
- Please keep the equipment installed horizontally or install the equipment in a stable place, taking care to prevent the product from falling.
- Do not drop or spill liquid into the device and ensure that no liquid-filled items are placed on the device to prevent liquid from flowing into the device.
- Install the device in a well-ventilated area, and do not block the ventilation openings of the device.
- Use the device only within the rated input and output range.
- Do not disassemble the device at will.
- Please transport, use and store the device within the permissible humidity and temperature range.

Power Requirement

- Be sure to use the specified manufacturer's model battery, otherwise there is a danger of explosion!
- Be sure to use the battery as required, otherwise there is a danger of the battery catching fire, exploding or burning!
- Only use the same model of battery when replacing the battery!
- Be sure to dispose of the used battery as the instruction of battery!

- Be sure to use the power adapter that meets standard with the device, otherwise the personal injury or equipment damage caused by the user will be borne by the user.
- Use a power supply that meets the SELV (Safety Extra Low Voltage) requirements and supply power according to the rated voltage of IEC60950-1 in accordance with the Limited Power Source. The specific power supply requirements are based on the equipment label.
- Connect the Class I product to plug with the power outlet with a protective ground connection.
- The appliance is coupled to the port unit. Keep it at an easy angle for normal use.

Important Statement

Users are required to enable and maintain the lawful interception (LI) interfaces of video surveillance products in strict compliance with relevant laws and regulations. Installation of surveillance devices in an office area by an enterprise or individual to monitor employee behavior and working efficiency outside the permitted scope of the local law and use of video surveillance devices for eavesdropping of illegal purposes constitute behaviors of unlawful interception.

Contents

Legal Notice	2
Network Security Advice	4
About This Document.....	7
Purpose	7
Modify Log.....	7
Symbol Conventions.....	10
Safety instructions.....	12
Requirements.....	12
Power Requirement	12
Important Statement	13
Contents.....	14
1 Preface	22
1.1 Product Description.....	22
1.2 Product Features	22
1.2.1 Cloud Upgrade	22
1.2.2 Real-time Monitoring	23
1.2.3 Playback	23
1.2.4 User Management.....	23
1.2.5 Storage Funtion	23
1.2.6 Alarm Function	23
1.2.7 Network Monitoring.....	24
1.2.8 Split Screen.....	24
1.2.9 Recording Function	24
1.2.10 Backup Function.....	24
1.2.11 External Device Control.....	25
1.2.12 Accessibility.....	25

2 Product Structure26

- 2.1 Front Panel 26
- 2.2 Back Panel 29
- 2.3 Important Notes 36
- 2.4 About This User Manual 37
- 2.5 Installation Environment and Precautions 37

3 Install device39

- 3.1 Process 39
- 3.2 Unpacking Inspection 40
- 3.3 Install Hard Disk..... 41
 - 3.3.1 Install One or Two Hard disks 41
 - 3.3.2 Install Four Hard disks 42
 - 3.3.3 Install Eight Hard disks 43

4 Basic Operations.....45

- 4.1 Power on the Device 45
- 4.2 Activation 45
- 4.3 Power off the Device 50
- 4.4 Login to the System 50

5 Wizard53

6 Quick Navigation62

- 6.1 Alarm message 64
- 6.2 Real Time Video Bar 65
- 6.3 Playback 68
 - 6.3.1 Time Search 71
 - 6.3.2 Picture Grid 72
 - 6.3.3 Event 73
 - 6.3.4 Backup..... 74
- 6.4 Thermal Temperature 75
 - 6.4.1 Temperature Parameters..... 75
 - 6.4.2 Temperature Area 80
 - 6.4.3 Schedule Linkage 84
 - 6.4.4 Advanced..... 86

6.4.5 Inquire	87
6.5 Attendance	88
6.5.1 Attendance Data.....	88
6.5.2 Attendance Management	89
6.6 AI Recognition	93
6.6.1 Real Time Comparison	93
6.6.1.1 Human Face	94
6.6.1.2 Vehicle License Plate	95
6.6.1.3 Vehicle and Full Body	95
6.6.2 Smart Search	96
6.6.2.1 Human Face Search.....	97
6.6.2.2 Vehicle License Plate Search	98
6.6.2.3 Full Body Search.....	99
6.6.2.4 Vehicle Search.....	100
6.6.2.5 Body Temperature Search	101
6.6.3 Archives Library.....	101
6.6.3.1 Face Library.....	102
6.6.3.2 License Plate Library	103
6.6.4 Comparison Configuration	103
7 UI System Setting	107
7.1 Channel Information	107
7.2 Main Menu.....	107
7.3 Channel Management	109
7.3.1 Camera	109
7.3.1.1 Add Camera Automatically	110
7.3.1.2 Add Camera Manually.....	110
7.3.1.3 Add Camera by RSTP.....	111
7.3.1.4 Delete Camera	113
7.3.1.5 Operate Camera	113
7.3.2 Encode Parameter	114
7.3.3 Sensor Setting	115
7.3.4 OSD Settings.....	117

7.3.5 Privacy Zone	118
7.4 Record Setting	120
7.4.1 Record Schedule	120
7.4.2 Disk	121
7.4.3 RAID	123
7.4.4 Storage Mode	124
7.4.5 S.M.A.R.T	125
7.4.6 Disk Detection	125
7.4.7 Cloud Storage	127
7.5 Alarm Management	129
7.5.1 General	129
7.5.2 Motion Detection	130
7.5.3 Video Loss	132
7.5.4 Intelligent Analysis	134
7.5.5 Alarm In	135
7.5.6 Abnormal Alarm	137
7.6 Network Management	138
7.6.1 Network	139
7.6.1.1 IP	139
7.6.1.2 Port	139
7.6.1.3 IPv4CCTV	140
7.6.1.4 POE	141
7.6.1.5 WiFi Parameter	142
7.6.1.6 WiFi Network	143
7.6.2 802.1 X	144
7.6.3 DDNS	145
7.6.4 E-mail	146
7.6.5 Port Mapping	148
7.6.6 P2P	148
7.6.7 IP Filter	149
7.6.8 SNMP	151
7.6.9 3G/4G	152

7.6.10 PPPOE.....	154
7.7 System Management	156
7.7.1 Information	156
7.7.2 General.....	157
7.7.2.1 System.....	157
7.7.2.2 Date and Time.....	158
7.7.2.3 Time Zone	159
7.7.2.4 DST.....	160
7.7.3 User	161
7.7.3.1 User.....	162
7.7.3.2 Advance Setting	164
7.7.4 Security Center	165
7.7.4.1 Password.....	166
7.7.4.2 Pattern Unlock	167
7.7.4.3 Secure Email.....	167
7.7.4.4 Secure Question	168
7.7.5 Auto Sequence	169
7.7.6 Auxliary Screen.....	170
7.7.7 Logs	172
7.7.8 Maintenance	173
7.7.9 Auto Restart	174
8 WEB Quick Start	176
8.1 Activation	176
8.2 Login and Logout	178
8.3 Browsing Videos	182
8.3.1 Browsing Real-Time Videos	182
8.3.2 Live Video	184
8.3.3 Channel Operation	185
8.3.4 PTZ Control and Setting.....	186
8.3.5 Sensor Setting	188
8.3.6 Layout.....	190
8.4 Playback	191

8.4.1 Video Playback	191
8.5 Alarm Search	193
8.5.1 Channel Alarm	193
8.5.2 System Alarm	196
8.6 Attendance	198
8.6.1 Attendance Data	198
8.6.2 Attendance Management	199
8.7 AI Recognition	202
8.7.1 Real Time Comparison	202
8.7.1.1 Human Face	203
8.7.1.2 Vehicle License Plate	203
8.7.1.3 Vehicle and Full Body	204
8.7.2 Smart Search	205
8.7.2.1 Human Face Search	206
8.7.2.2 Vehicle License Plate Search	207
8.7.2.3 Full Body Search	208
8.7.2.4 Vehicle Search	209
8.7.2.5 Body Temperature Search	210
8.7.3 Archives Library	210
8.7.3.1 Face Library	211
8.7.3.2 License Plate Library	212
8.7.4 Comparison Configuration	212
9 System Setting	216
9.1 Channel	216
9.1.1 Camera	216
9.1.1.1 Protocol Management	218
9.1.2 Encode	219
9.1.3 Sensor Setting	220
9.1.4 OSD	222
9.1.5 Privacy Zone	223
9.2 Record	224
9.2.1 Record Schedule	224

9.2.2 Disk.....	226
9.2.3 RAID	227
9.2.4 S.M.A.R.T.....	229
9.2.5 Storage Mode.....	230
9.2.6 Cloud Storage	231
9.3 Alarm	232
9.3.1 General.....	232
9.3.2 Motion Detection.....	233
9.3.3 Video Loss	235
9.3.4 Intelligent Analysis	236
9.3.5 Alarm In.....	237
9.3.6 Abnormal Alarm	238
9.4 Network.....	239
9.4.1 Network	240
9.4.2 DDNS	241
9.4.3 E-mail	242
9.4.4 Port Mapping	243
9.4.5 P2P	243
9.4.6 IP Filter	244
9.4.7 802.1X	246
9.4.8 SNMP.....	247
9.4.9 Web Mode.....	249
9.4.10 3G/4G.....	250
9.4.11 PPPOE.....	250
9.5 System	251
9.5.1 Device Information.....	251
9.5.2 General.....	253
9.5.3 User.....	256
9.5.3.1 Add User	256
9.5.3.2 Adv.Setting	258
9.5.4 Security Center.....	259
9.5.4.1 Password.....	259

9.5.4.2 Secure Email..... 260

9.5.4.3 Secure Question 260

9.5.5 Logs 261

9.5.6 Maintenance 262

9.5.7 Auto Restart 263

9.6 Local 263

10 Disk Compatibility265

1.1 Product Description

This product is a high performance NVR device. The product has local preview, video multi-screen split display, local real-time storage function of video files, support for mouse shortcut operation, remote management and control functions.

This product supports three storage methods: central storage, front-end storage, and client storage. The front-end monitoring point can be located anywhere in the network without geographical restrictions. It is combined with other front-end devices such as network cameras, network video server networks, and professional video surveillance systems to form a powerful security monitoring network. In the networked deployment system of this product, the central point and the monitoring point need only one network cable to connect. It is not necessary to set up visual and audio lines to the monitoring point, and the construction is simple, and the wiring cost and maintenance cost are low.

This product is widely used in public security, transportation, electric power, education and other industries.

1.2 Product Features

1.2.1 Cloud Upgrade

For devices that have access to the public network, you can update the software of the device through online upgrade.

1.2.2 Real-time Monitoring

It has a VGA (Video Graphics Array) port and an HDMI (High Definition Media Interface) port. It can be monitored by a monitor screen or monitor, and supports simultaneous output of VGA and HDMI.

1.2.3 Playback

Each channel can independent real-time recording, and play functions such as retrieval, playback, network monitoring, video query, and download. Please refer to chapter Playback

Multiple playback modes: slow release, fast release, reverse playback, and frame-by-frame playback.

The exact time when the event occurred can be displayed during playback of the recording. You can select any area of the screen for partial magnification.

1.2.4 User Management

Each user group has a rights management set, which can be selected autonomously. The total rights set is a subset, and the user rights in the group cannot exceed the rights management set of the user group.

1.2.5 Storage Funtion

According to the user's configuration and policies (such as through alarm and timing settings), the corresponding audio and video data transmitted by the remote device is stored in the NVR device. For details, please refer to chapter Storage Management.

Users can record by WEB mode as needed. The video files are stored on the computer where the client is located. Please refer to chapter Storage.

1.2.6 Alarm Function

Real-time response to external alarm input, correct processing according to the user's preset linkage settings and give corresponding prompts.

The setting options of the central alarm receiving server are provided, so that the alarm information can be actively and remotely notified, and the alarm input can come from various external devices connected.

The alarm information can be notified to the user by mail or APP push information.

1.2.7 Network Monitoring

Through the network, the audio and video data of the IP camera or NVS (Network Video Server) of the NVR device is transmitted to the network terminal for decompression and reproduction.

The device supports 8 simultaneous online users to perform streaming operations.

The audio and video data is transmitted using protocols such as HTTP (Hyper Text Transfer Protocol), TCP (Transmission Control Protocol), UDF (User Datagram Protocol), MULTICAST, RTP (Real-time Transport Protocol), and RTCP (Real Time Streaming Protocol).

Use SNMP (Simple Network Management Protocol) for some alarm data or information
Support WEB mode access system, applied to WAN, LAN environment.

1.2.8 Split Screen

Image compression and digitization are used to compress several images in the same scale and display them on the display of a monitor. 1/4/8/9/16/32 screen splitting is supported during preview; 1/4/9/16 screen splitting is supported during playback.

1.2.9 Recording Function

The device supports regular recording, motion detection recording, alarm recording, and intelligent recording. The recording file is placed on the hard disk device, USB (Universal Serial Bus) device, and client PC (personal computer). It can be connected to the WEB terminal, USB device, or local device. Query and playback the stored video files.

1.2.10 Backup Function

Support USB2.0 and eSATA video backup.

1.2.11 External Device Control

The peripheral control function is supported, and the control protocol and connection interface of each peripheral can be freely set.

Support transparent data transmission of multiple interfaces, such as: RS232, RS485.

1.2.12 Accessibility

Supports video NTSL (Nation Television Standards Committee) system and PAL (Phase Alteration Line) system.

Supports system resource information and real-time display of running status.

Supports for logging recording.

Supports local GUI (Graphical User Interface) output and quick menu operation via mouse.

Supports playback of audio and video from remote IPC or NVS devices.



NOTE

For other functions, please see the following text.

2 Product Structure

2.1 Front Panel

Figure 2-1 One disk/four disks model



Table 2-1 Front panel function

Port	Description
PWR	When the NVR is operating, the PWR indicator is steady on. When the NVR is shut down, the PWR indicator is turned off.
HDD	Hard disk status indicator This indicator flashes when data is transmitted.
POE	PoE network status indicator This indicator flashes when data is transmitted.
KB/MOUSE	Only supports connected to an USB mouse.
BACKUP	Only supports connected to U disk

Figure 2-2 One disk model



Table 2-2 Front panel function

Port	Description
PWR	When the NVR is operating, the PWR indicator is steady on. When the NVR is shut down, the PWR indicator is turned off.
NET	Network status indicator This indicator flashes when data is transmitted.
REC	Hard disk status indicator This indicator flashes when data is transmitted.
	Only supports connected to an USB mouse

Figure 2-3 Eight disk model

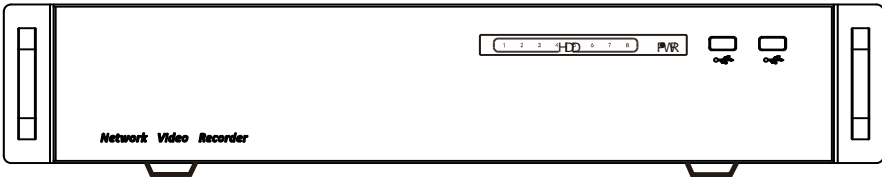

Table 2-3 Front panel function



Port	Description
PWR	When the NVR is operating, the PWR indicator is steady on. When the NVR is shut down, the PWR indicator is turned off.
HDD	Hard disk status indicator This indicator flashes when data is transmitted.
	Only supports connected to an USB mouse

Figure 2-4 WiFi model



Table 2-4 Front panel function

Port	Description
PWR	When the NVR is operating, the PWR indicator is steady on. When the NVR is shut down, the PWR indicator is turned off.
NET	Network status indicator This indicator flashes when data is transmitted.
REC	Hard disk status indicator This indicator flashes when data is transmitted.
	Only supports connected to an USB mouse

2.2 Back Panel

Figure 2-5 One disk 4 POE

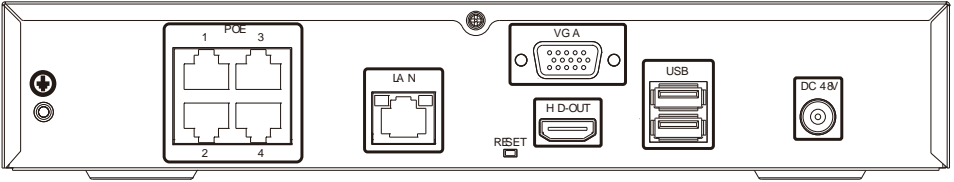

Figure 2-6 Two disks 8 POE

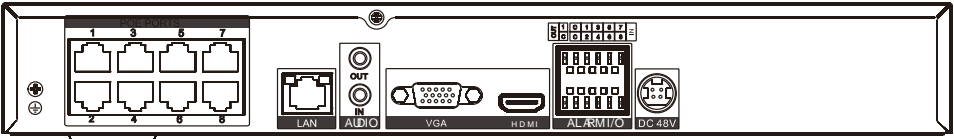

Table 2-5 Real panel function

Port	Description
POE	POE network interfaces
LAN	RJ 45 10/100/1000 Mbps adaptive Ethernet interface
AUDIO OUT / AUDIO IN	Audio output / Audio input
VGA	Video output interface
HDMI	
Alarm I/O	Alarm input/Alarm output
	GND
DC48V	Connected to an external power adapter

Figure 2-7 One disk 8 POE

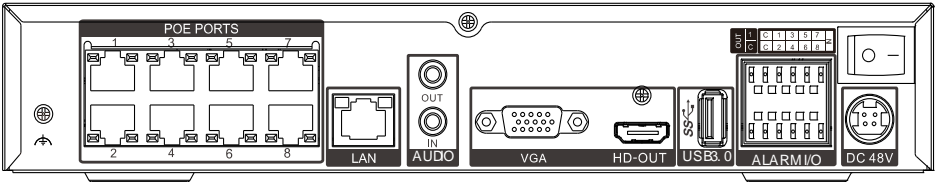

Table 2-6 Real panel function

Port	Description
POE	POE network interfaces
LAN	RJ 45 10/100/1000 Mbps adaptive Ethernet interface
AUDIO OUT / AUDIO IN	Audio output / Audio input
VGA	Video output interface
HDMI	
USB 3.0	Only supports connected to 3.0 U disk
Alarm I/O	Alarm input/Alarm output
	GND
DC48V	Connected to an external power adapter

Figure 2-8 Four disks/ eight disks

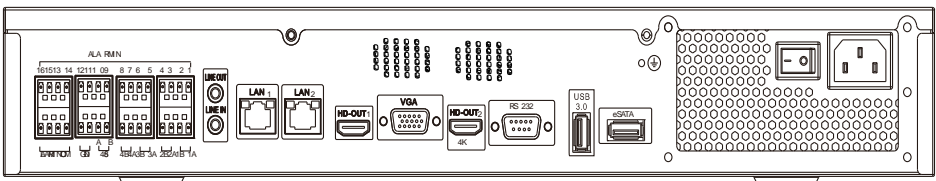

Table 2-7 Real panel function





Port	Description
	Alarm input and alarm output./RS485
LINE OUT / LINE IN	Audio output / Audio input
LAN1 /LAN2	RJ 45 10/100/1000 Mbps adaptive Ethernet interface
VGA	Video output interface
HDMI (1/2)	
RS232	Standard RS232 serial communication interface of the device
USB 3.0	Only supports connected to 3.0 U disk
E SATA	External hard disk interface
	Power switch
	Safe ground screw of the device
	AC 110V/220V power input interface

Figure 2-9 Four disks 16 POE

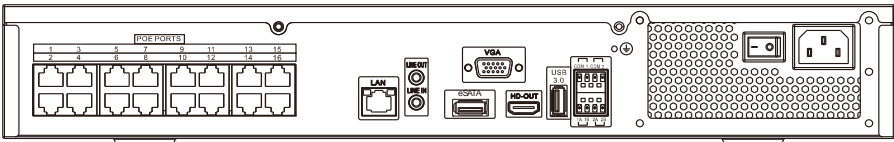



Table 2-8 Real panel function

Port	Description
POE port	POE network interfaces
	Alarm input and alarm output./RS485



LINE OUT / LINE IN	Audio output / Audio input
LAN	RJ 45 10/100/1000 Mbps adaptive Ethernet interface
VGA	Video output interface
HDMI	
RS232	Standard RS232 serial communication interface of the device
USB 3.0	Only supports connected to 3.0 U disk
E SATA	External hard disk interface
	Power switch
	Safe ground screw of the device
	AC 110V/220V power input interface

Figure 2-10 WiFi model

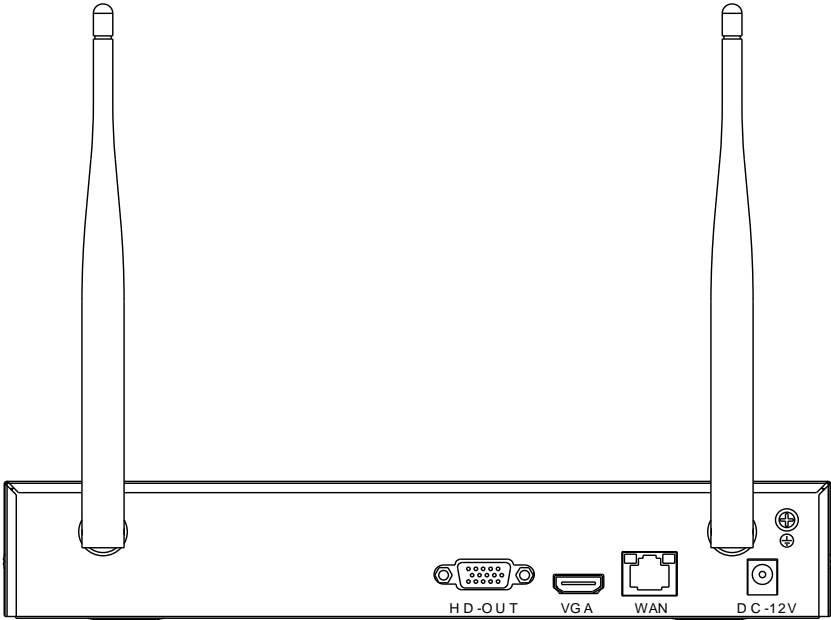
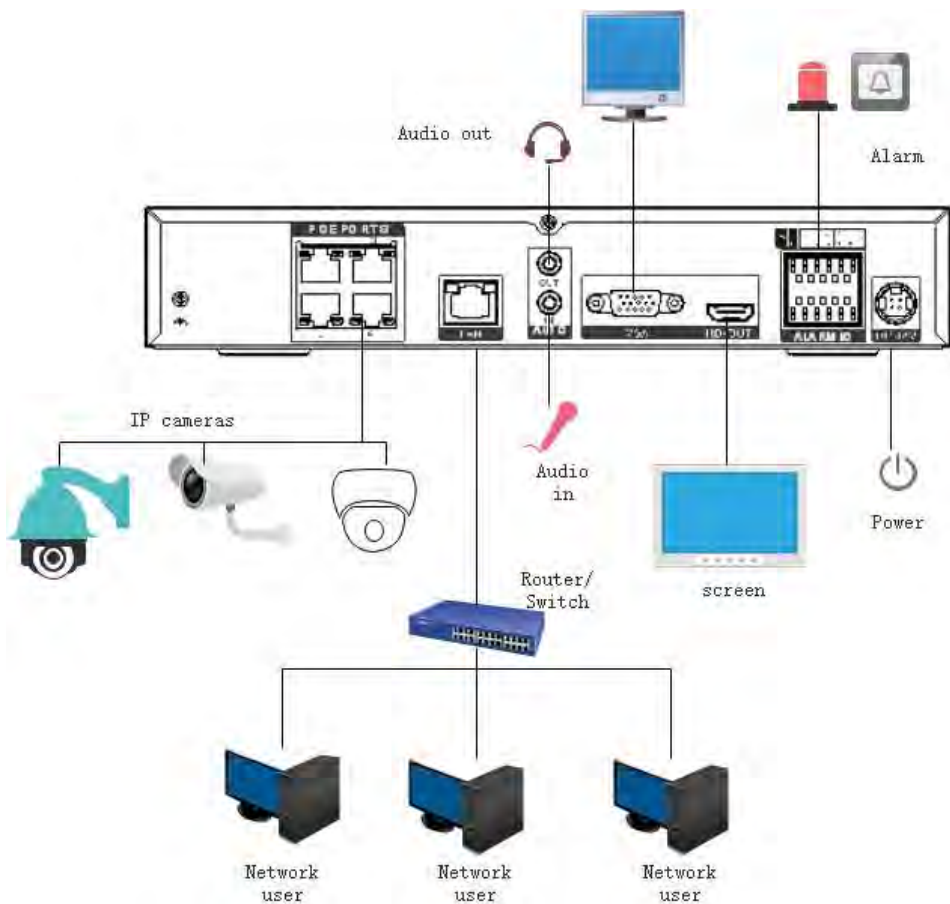
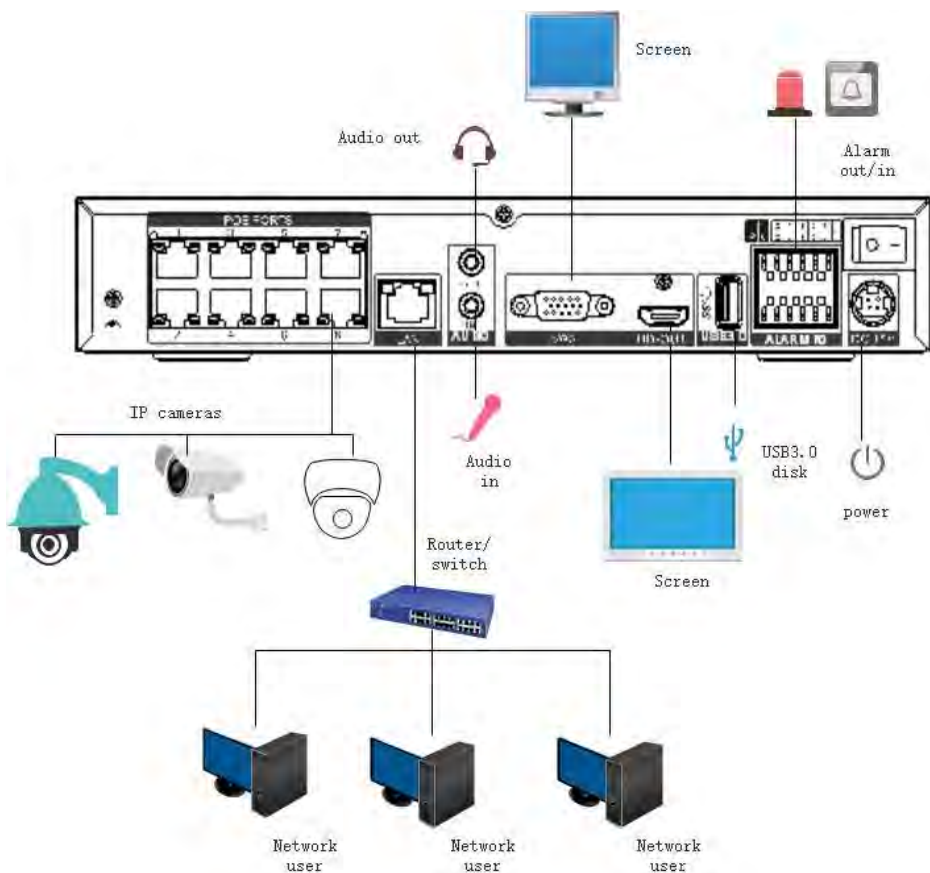
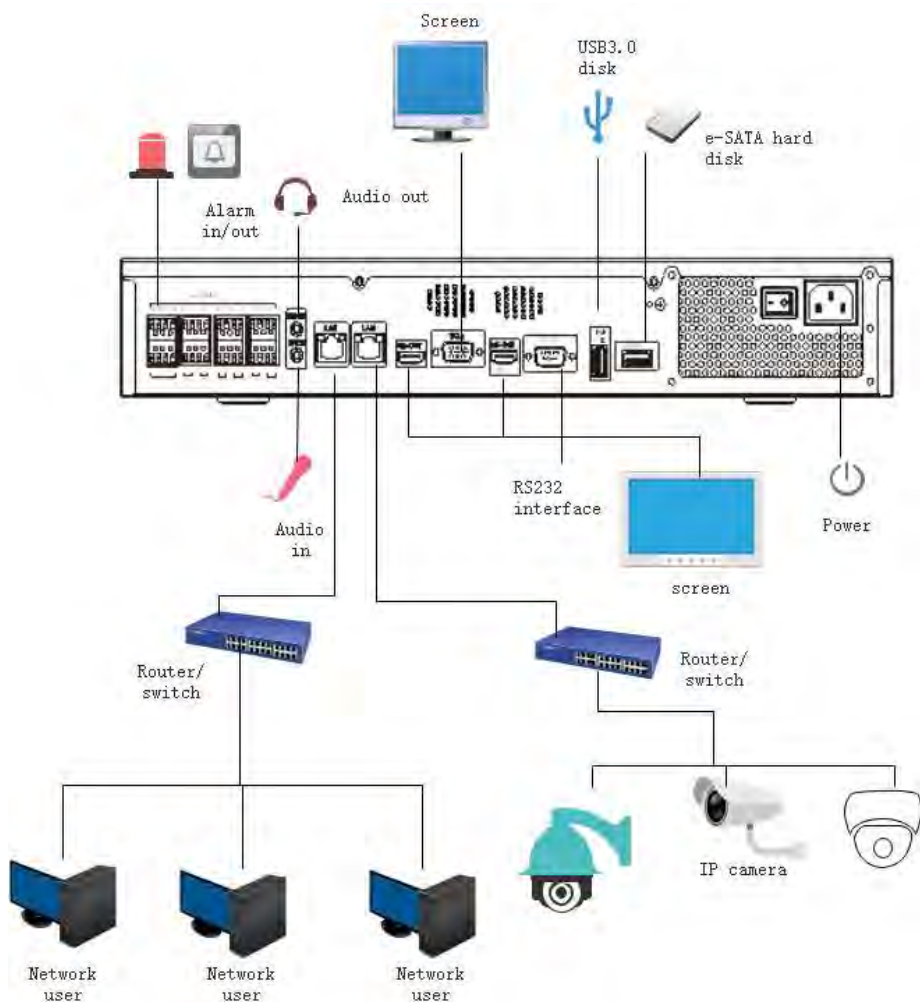

Table 2-9 Real panel function

Port	Description
WAN	RJ 45 10/100/1000 Mbps adaptive Ethernet interface
VGA	Video output interface
DC 12V	Connected to an external power adapter
⏏	Safe ground screw of the device







2.3 Important Notes

Thank you for choosing the NVR. Please read the user manual carefully before using this product.

The NVR is a complex system-based device. To avoid misoperations and malfunctions caused by environmental factors and human factors during installation, commission, and application, note the following points when installing and using this product:

Read the user manual carefully before installing and using this product.

- Use Monitoring dedicated hard disks as the storage devices of the NVR with high stability and competitive price/performance ratios (the quality of hard disks sold on markets varies greatly with different brands and models).
- Do not open the enclosure of this product unless performed by a professional person to avoid damage and electric shock.
- We are not liable for any video data loss caused by improper installation, configuration, operation, and hard disk errors.
- All images in the document are for reference only, please subject to the actual products.

2.4 About This User Manual

Please note the following points before using this user manual:

- This user manual is intended for persons who operate and use the NVR.
- The information in this user manual applies to the full series NVR, NVR as an example for description.
- Read this user manual carefully before using the NVR and follow the methods described in this manual when using the NVR.
- If you have any doubts when using the NVR, contact your product seller.
- In the case of product upgrade, the information in this document is subject to change without notice.

2.5 Installation Environment and Precautions

Installation environment

Table 2-10 defines the installation environment of the NVR.

Table 2-10 Installation environment

Item	Description
Electromagnetism	The NVR conform to national standards of electromagnetic radiation and does not cause harm to the human body.
Temperature	-10°C to +45°C
Humidity	20% to 80%
Atmospheric pressure	86 Kpa to 106 Kpa

Item	Description
Power supply	DC 12V, DC 48V 2A(1 HDD) or AC110/ 220V 4A(2 HDDs or more), please refer to actual product.
Power consumption	<15W (excluding the hard disk)

Installation precautions

Note the following points when installing and operating the NVR:

- The power adapter of the NVR uses DC48V±20% input. Do not use the NVR when voltage is too high or too low.
- Install the NVR horizontally.
- Avoid direct sunlight on the NVR and keep away from any heat sources and hot environments.
- Connect the NVR to other devices correctly during installation.
- The NVR is not configured with any hard disk upon delivery. Install one or more hard disks when using the NVR for the first time.

The NVR identifies hard disk capacity automatically and supports mainstream hard disk models.

User should use good brands of hard disk so that the NVR can operate stably and reliably, please refer to chapter 10 Disk Compatibility

Other precautions

- Clean the NVR with a piece of soft and dry cloth. Do not use chemical solvents.
- Do not place objects on the NVR.

The NVR meets the national standards of electromagnetic radiation and does not cause electromagnetic radiation to the human body.

Series of NVR

3 Install device

3.1 Process

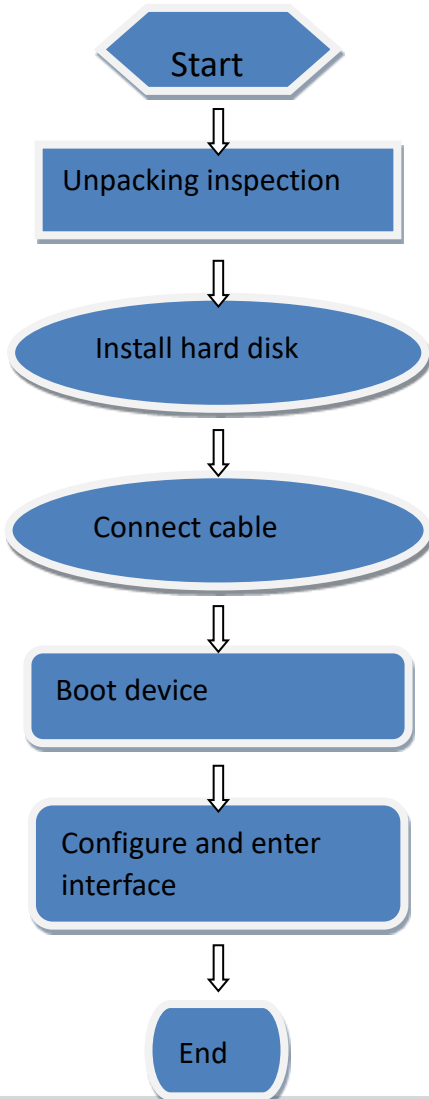



- Step 1 Check the appearance, packaging, and label of the device to ensure which no damage.
- Step 2 Install the hard disk and fix the hard disk on the device bracket.
- Step 3 Connect the device cable.
- Step 4 After ensuring that the device is connecting correct, connect the power and turn on the device.
- Step 5 Configure the initial parameters of the device. The boot wizard contains network configuration, add cameras, and manage disks. For details, please refer to the chapter of Wizard .

3.2 Unpacking Inspection

When the transportation company sends network video recorder to you, please check the following table for unpacking. If you have any questions, please contact our sales technicians.

Table 3-1 Unpacking inspection

No	Item		Check content
1	Overall packaging	Appearance	Is there any obvious damage
		Package	Is there accidental impact
		Accessories	Is it complete
2	Label	Label of device	<p>Is the equipment model consistent with the order contract?</p> <p>Whether the label is torn</p> <p> NOTE</p> <p>Do not tear or discard, otherwise warranty service is not guaranteed. When you call the company for sales personnel calls, you will need to provide the serial number of the</p>

			product on the label.
3	Cabinet	Package	Is there any obvious damage
		Data cable, power cable, fan power supply, and motherboard	<p>Is the connection loose?</p> <p> NOTE</p> <p>If it is loose, please contact the company's after-sales personnel.</p>

3.3 Install Hard Disk

When installing for the first time, first check if the hard disk is installed. It is recommended to use the company recommended hard disk model 9 disk compatibility.

It is not recommended to use a PC dedicated hard disk.

CAUTION

When replacing the hard disk, please turn off the power and then open the device to replace the hard disk.

Please use the monitoring dedicated SATA hard disk recommended by the hard disk manufacturer.

Use a reasonable hard disk capacity according to the recording requirements.

3.3.1 Install One or Two Hard disks

Step 1 Remove the screws for fixing the upper cover and take down the cover.

Step 2 Take out the screws and silicone cushion, route the screws through the silicone cushion, and install it to the screw holes, as show in Figure 3-1..

Figure 3-1 Installing the hard disk screws

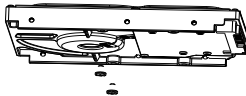

Step 3 Route the screws through the hole on the base, push the hard disk to the appropriate position on the left, as shown in Figure 3-2.

Figure 3-2 Install hard disk

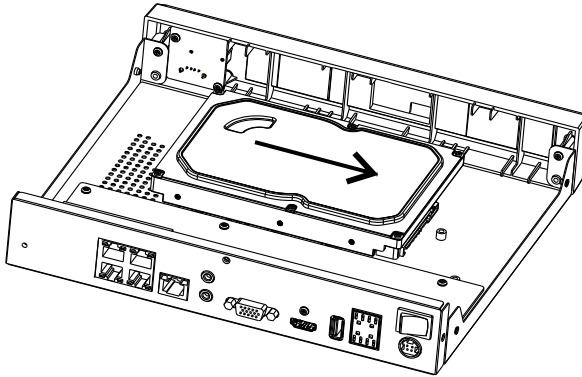

Step 4 Turn the device over, and fasten the rest two hard disk fixing screws, as shown in Figure 3-3.

Figure 3-3 Install hard disk

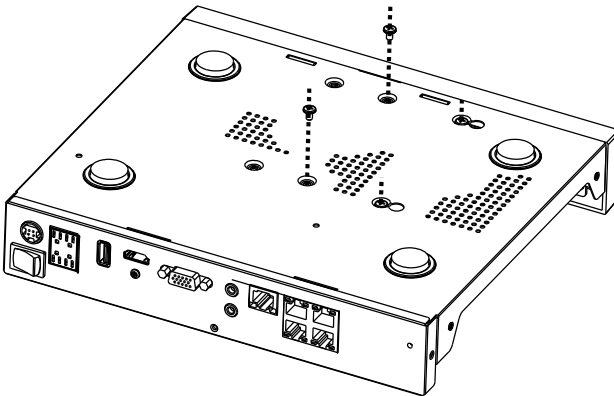

Step 5 Insert the hard disk data cable and power cable, then put on the upper cover and fasten the fixing screws.

3.3.2 Install Four Hard disks

Step 1 Remove the screws for fixing the upper cover and take down the cover.

Step 2 Put the hard disk under the hard disk bracket, hold the hard disk with one hand and aim the hard disk hole at the bracket hole, then fix the screws for hard disk (install the hard disk near the fan first), as shown in Figure 3-4.

Figure 3-4 Installing the hard disks

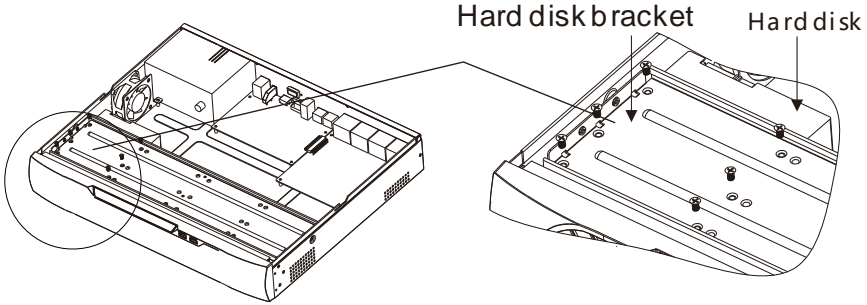

Step 3 Install other hard disks following step 2.

Step 4 Insert the hard disk data cable and power cable, then put on the upper cover and fasten the fixing screws.

3.3.3 Install Eight Hard disks

Step 1 Remove the screws for fixing the upper cover and take down the cover.

Step 2 Unscrew the screws on both sides and the upside of the upper bracket respectively, lift the upper bracket, as shown

Figure 3-5 Unscrew the screws lift the upper bracket

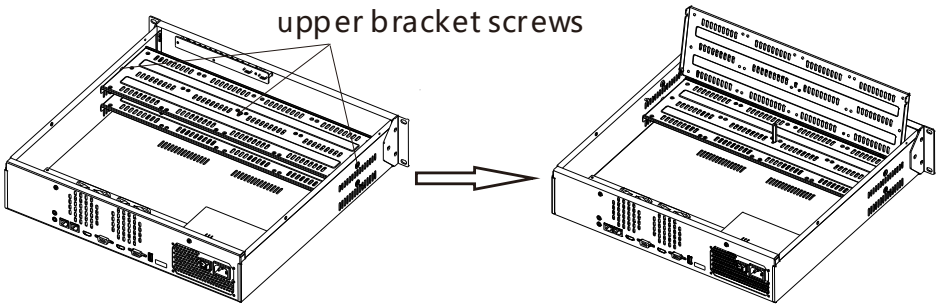

Step 3 Put the hard disk under the lower bracket, hold the hard disk with one hand and aim the hard disk hole at the bracket hole, then fix the screws for hard disk, as shown in Figure 3-6.

Step 4 Pull down upper bracket and screw it, then install other hard disks in upper layer following step 3, as shown in the right figure in Figure 3-6.

Figure 3-6 Unscrew the screws

lift the upper bracket

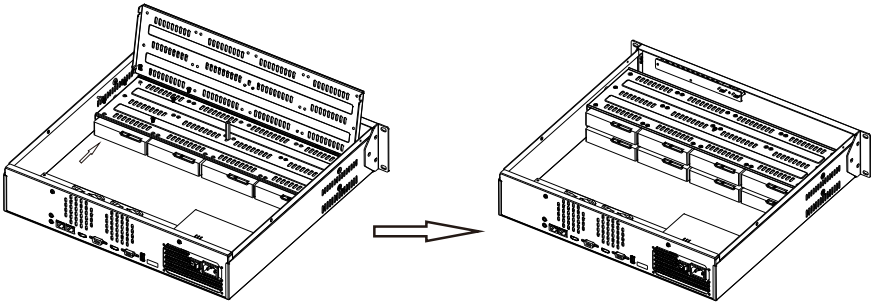

Step 5 Insert the hard disk data cable and power cable, then put on the upper cover and fasten the fixing screws.

4 Basic Operations

4.1 Power on the Device



CAUTION

- Ensure that the NVR is correctly connected to a power supply, and a display is correctly connected to the high definition multimedia interface (HDMI) or video graphics array (VGA) port of the NVR before power-on.
 - In some environments, abnormal power supply may cause the failure of the NVR to work properly and even damage the NVR in severe cases. It is recommended to use a regulated power supply to power the NVR in such environments.
-

After the NVR is connected to a power supply, the power indicator is steadily on. Start the NVR. The real-time video screen is displaying, as shown in Figure 4-1.

Figure 4-1 Real-time video screen



NOTE

Users need to provide a hard disk for the NVR. The hard disk is strictly detected during device startup. If the detection result failed, the possible causes are as follows.

The hard disk is new and is not formatted. Login to the system and format the hard disk.

The hard disk is formatted, but the file system is inconsistent with the file system supported by the NVR. Format the hard disk.

The hard disk is damaged.

4.2 Activation

When the user login the device at first time, or reset the NVR, you need to activate the device and set login and channel default password, as shown in Figure 4-2.

Figure 4-2 Activation

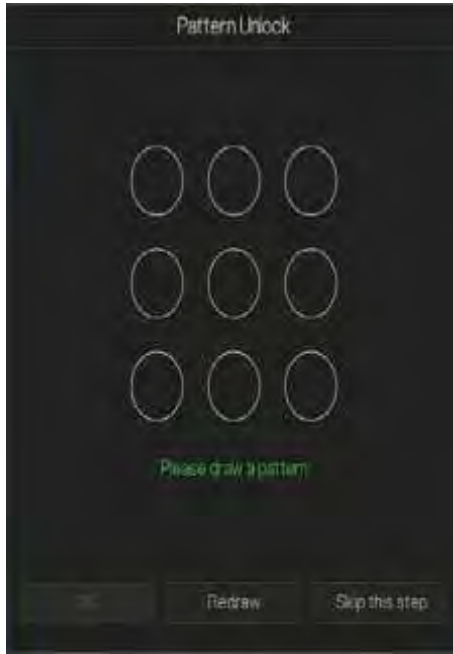

Table 4-1 Description of activation

Name	Description
Username	The default username is admin, and “admin” is super administrator.
Password	Valid password range 6-32 characters.
Confirm password	At least 2 kinds of numbers, lower case, upper case or special characters contained. Only these special characters are supported !@#\$*+ -= _%&” Channel default password limit is not empty.
Channel password	The NVR channel connection password is the camera login password.

User can set the pattern unlock to login the device, as shown in Figure 4-3.

Figure 4-3 Set pattern unlock



 **NOTE**

After the pattern is unlocked, the system defaults to the pattern unlock login. If the pattern unlock is not set, you will need to input the password to login.

If you don't need to set the pattern to unlock, click "Skip this step".

Set the Email to receive the verification code if user forget the initial password to create new password, as shown in Figure 4-4.

Figure 4-4 Set Email

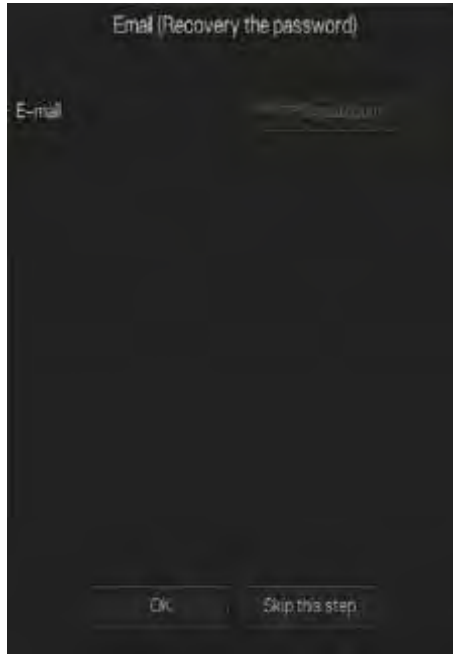

 **NOTE**

Set the email address, if you forget the password, you can through the email address to receive the verification, and reset the password.

If the email address is not set, you can reply to the secure question or send the QR code to the seller to give the temporary password to login to the device..

If you don't need to set the email, click "Skip this step".

Set the secure question, if user forgot the password can through the secure questions to create new password to login the device.

Figure 4-5 Set question

Question (Recovery the password)

Question one: The brand and model of ▾

Question one answer: _____

Question two: Your favorite team ▾

Question two answer: _____

Question three: Your favorite city ▾

Question three answer: _____

- Please enter at least 4 characters for the answer

- Please enter up to 32 characters for the answer

OK Skip this step

 **NOTE**

The user can set three questions, and if they forget the password, they can answer the question and enter the reset password interface.

Question one can be set: Your favorite animal

Company name of your first job

The name of the first boy/girl you like

The worst security question you have ever seen

The most funning/worst design you have ever seen

Question 2: Your favorite team

Question 3: Your favorite city

The three question options cannot be set to the same issue.

The answer requires a minimum of four characters and a maximum of 32 characters.

If you do not want to set a password question, you can click Skip this step.

4.3 Power off the Device

Click the main menu and choose **System > Maintenance**, the maintenance setting page is displaying, click **Shutdown** to power off the NVR. If there is a power switch on the rear panel of the NVR, you can RPM off the power switch to disconnect the NVR from the power supply.

4.4 Login to the System

Step 1 Login to the device, there are two modes to login if you set the pattern unlock, as shown in

Figure 4-6 Pattern unlock login page



Step 2 On the NVR login page, click “ Password” to at pattern unlock interface. If user don't set the pattern unlock it will show password to login interface directly, select the language, as shown in Figure 4-7.

Figure 4-7 Password login page



Step 3 Input the username and password.

 **NOTE**

The password incorrect more than 3 times, please login again after 5 minutes. You can also power off, and power on to start on the device, input the correct password to avoid waiting five minutes.

If user forget password, click Forgot password. User can choose a way to create new password:

1. Scan the QR code and send the QR code to your seller, seller send the verification code to user and set new password to login .
2. Answer the secure question to create new password.

Step 4 Click Login to access the main User Interface (UI).

Step 5 Modify the default password, as shown in Figure 4-8

Figure 4-8 Modify default password

Modify default password

New password

Confirm password

Modify password

- Valid password range (8-32) characters.
- At least 2 kinds of numbers, lowercase, uppercase or special character contained.
- Only special characters are supported !@#\$%^&*~_-

----End

5 Wizard

Login the NVR, the wizard is showing on live video, click **Start Wizard**, the pop-up window will show as Figure 5-1.

Figure 5-1 Wizard

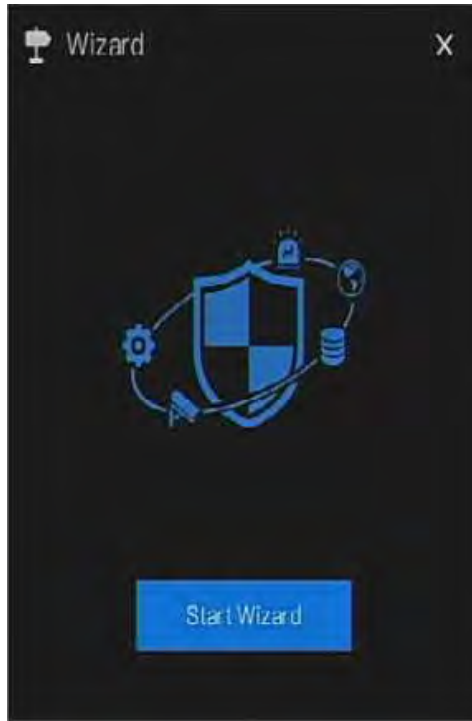

Figure 5-2 Wizard of network



Step 1 Set the parameter, the details please refer to Table 5-1.

Table 5-1 Network parameter

Parameter	Description	Configuration
DHCP	Enable DHCP, the device will obtain the IP address from the DHCP server.	[Setting method] Enable
IP Address	Set the IP of device when DHCP is disable	[Setting method] Manual

Parameter	Description	Configuration
Subnet mask	Set the subnet mask of device	[Setting method] Manual [Default value] 255.255.255.0
Gateway	If the user wants to access device, he must set that	[Setting method] Manual [Default value] 192.168.0.1
Obtain DNS automatically	N/A	[Setting method] Enable
DNS 1	N/A	[Setting method] Manual [Default value] 192.168.0.1
DNS 2	N/A	[Setting method] Manual [Default value] 192.168.0.1
UPnP	Auto: device to obtain Web port, data port and client port. Manual: user set the port manually.	[Setting method] Choose type from drop-down list [Default value] Auto
Web Port	N/A	[Setting method] When UPnP is manual, you need to set these.
Data Port	N/A	
Client	N/A	

Step 2 Click **Next** to view the basic information about device, as shown in Figure 5-3.

Figure 5-3 Wizard of date and time

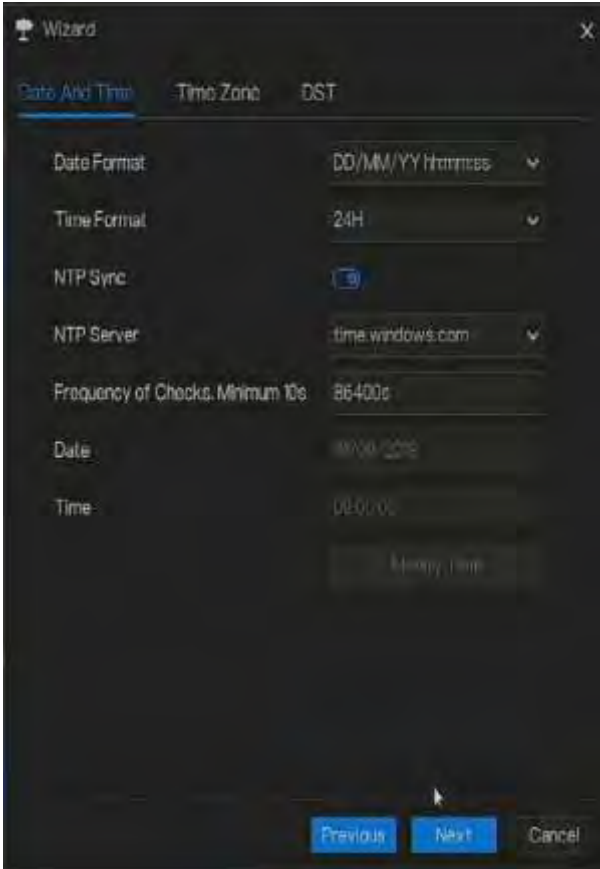

Choose date format and time format from drop-down list.

Click  to synchrony time from network.

Disable the NTP-Sync, set time manually.

Roll the mouse to choose year, month and day when clicking the date.

Roll the mouse to choose hour, minute and second when clicking the date.

Click **Modify Time** to save the time.

Step 3 Click **Time Zone**, choose the current time zone from drop-down list, as shown in Figure 5-4.

Figure 5-4 Wizard of time zone

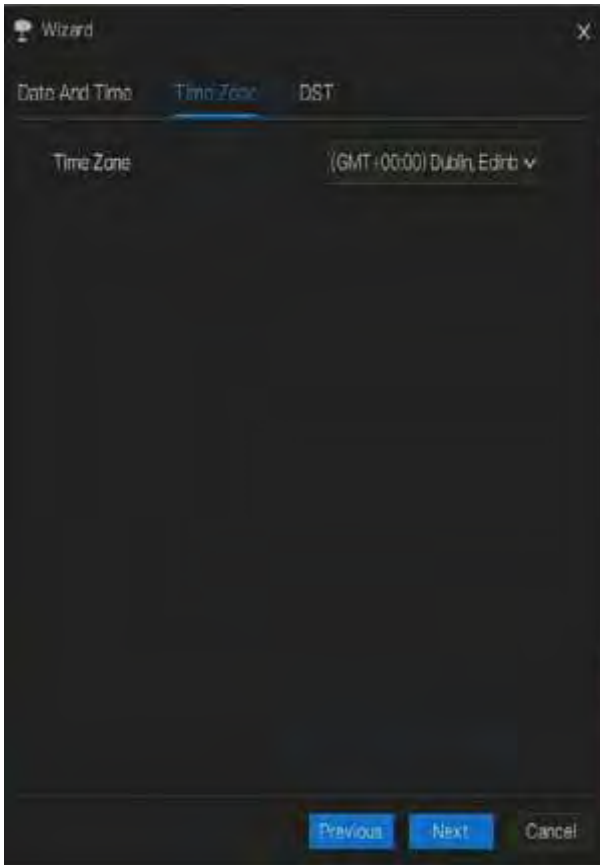

Step 4 Click **DST**, enable the DST, set start and end time. Select offset time from drop-down list.

Step 5 Click **Next** to enter the adding camera wizard, as shown in Figure 5-5.

Figure 5-5 Wizard of adding camera



The details of adding camera please refer to *chapter 7.3*.

Step 6 Click **Next** to enter wizard of disk, as shown in Figure 5-6.

Figure 5-6 Wizard of disk

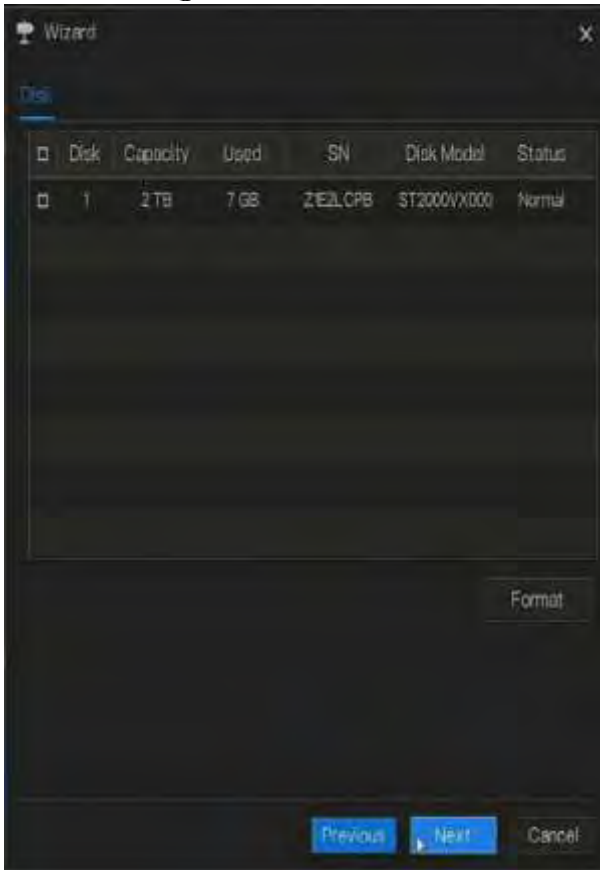

You can view the general information of disk. You can also format the disk.

Step 7 Click **Next** to enter wizard of P2P, as shown in Figure 5-7

Figure 5-7 P2P



Step 8 Enable the P2P, user can use mobile devices to manage the NVR by scanning the P2P ID, if the mobile phone has loaded the InView Pro 4(search the APP at App Store or Google Play).

Step 9 Click **Next** to enter the wizard of resolution , as shown in Figure 5-8. Choose resolution from drop-down list.

Figure 5-8 Wizard of resolution

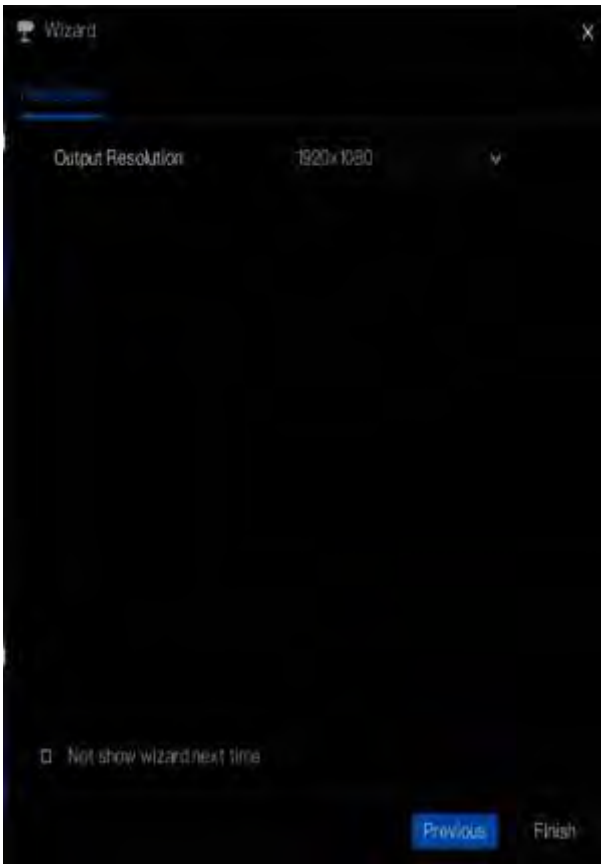

Step 10 Click **Finish** to end the wizard, tick the **Not show this window next time**, wizard would not show at next time. Reopen wizard at **system >user >advance setting**.

6 Quick Navigation

After the NVR operation screen is displaying, move the cursor to the down most position of the NVR screen. The NVR floating menu bar is displaying.

Click  in the left of NVR floating menu bar. The quick home menu is showing. The quick home menu provides **Playback, System and Power(Shutdown, Reboot and Logout)** as shown in Figure 6-1.

Figure 6-1 Quick home menu



In the middle of NVR floating menu bar, the video tool bar provides **video window switching, auto SEQ, volume, playback, and channel information**, as shown in Figure 6-2.

Figure 6-2 Real-time video toolbar



The real-time video toolbar is described as follows:



: Layout. Click the icon, the real-time video window switch

between the single-screen mode and multi-screen mode. Click  on the right of screen splitting format and choose the channels to view the video.



: Auto SEQ. click icon, the layout dwell on screen is enabled, for how to set the dwell on, please see *chapter 7.7.5*.



: Audio. Click icon, the audio setting screen is displaying, which you can choose the channel and adjust the volume.



:channel information, tick the channel or encode, the live video will show the channel information.

A main menu quick toolbar is display on the right of NVR floating menu bar. The main menu quick toolbar provides **manual alarm**, **alarm information**, **clean alarm information** and **time**, as shown in Figure 6-3.

Figure 6-3 Main menu quick toolbar



: Manual alarm, click the icon, the window shows in Figure 6-4.

Figure 6-4 Manual alarm

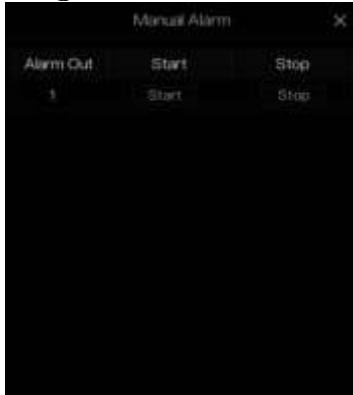

: Alarm message, click icon would show pop-up message window, as shown in 6.1.

6.1 Alarm message

Channel	Type	Start time
ChannelB	Motion Detection	27/12/2018 17:32:57
ChannelB	Motion Detection	27/12/2018 17:32:43
ChannelB	Motion Detection	27/12/2018 17:31:53
ChannelB	Motion Detection	27/12/2018 17:31:01
ChannelB	Motion Detection	27/12/2018 17:29:23
ChannelB	Motion Detection	27/12/2018 17:23:40
ChannelB	Motion Detection	27/12/2018 17:23:36
ChannelB	Motion Detection	27/12/2018 17:23:24
ChannelB	Motion Detection	27/12/2018 17:23:13
ChannelB	Motion Detection	27/12/2018 17:18:14



: Clean alarm, click icon and clean the current alarm actions like voice and external alarm out.



: Information, click icon and the general information would show, like network, system, channel and disk, as shown in Figure 6-5.

Figure 6-5 Information



6.2 Real Time Video Bar

Click realtime image, the quick setting will show as figure.



Record: click the icon and start to record video. Click again to end record.

Instant playback: click the icon, the window will play previous five minutes record video.

 is the time bar of playback.

Audio: open or close the audio.

PTZ: This function only is useful for speed dome cameras. You can adjust every parameter as shown in Figure 6-6.

Figure 6-6 PTZ adjust screen



: User adjust direction of camera.



: At this part, user can set **Advanced**, **Scan** and **Tour** settings.



: 3D, this function only can be used for high speed dome camera. Click the icon to enter the camera live video screen, use the mouse to move the camera or zoom in or out the lens. Click the point to zoom in. Drag and draw the area, zoom in the drawing area, Reverse drag to zoom out.



: Zoom in, click zoom in, roll the mouse wheel to zoom in and zoom out. Right-click to exit the zooming.



: Image, click the icon ,as shown in Figure 6-7. Select scene, and drag cursor to adjust value of brightness, sharpness, contrast and saturation.

Figure 6-7 Camera picture parameter



: Two way audio. The NVR and camera can talk to each other.



: fisheye, click to switch the fisheye modes, as shown in Figure 9-23.

Figure 6-8 Fisheye



: Modify device parameters, as shown in Figure 6-9.

Figure 6-9 Modify device parameter

Device Name	Channel07
IP Address	192.168.177
Protocol	Private_SSL
Port	20001
Username	admin
Password	*****
Remote Channel	CH-1

OK Cancel

6.3 Playback

Playback refers to playing back a video.



Click  in the quick navigation bar to access the playback screen, as shown in Figure 6-10.

Figure 6-10 Playback screen





The toolbar at the bottom of the playback screen is described as follows:



: Layout.

: Reversed, pause/play, stop.

:30s backward, 30s forward.

:Triple speed, it supports up to 32 times to playback.

: Zoom.

: Audio.



: Start and end backup. Click the icon, the video backup starts, select the video and click the icon again.

The backup type shows, click **save**, then saving the file pop-up windows would show as Figure 6-11 . Click **OK** to save.

This function is available after a USB disk is plugging in the device.

Figure 6-11 Select directory



: Batch backup, click the icon to backup multi-channels, as shown in Figure 6-12.

Choose the folder to save, select the stream information from drop-down list, set the start time and end time, select the channels, Click **OK** to backup.

Figure 6-12 Batch backup

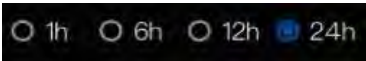
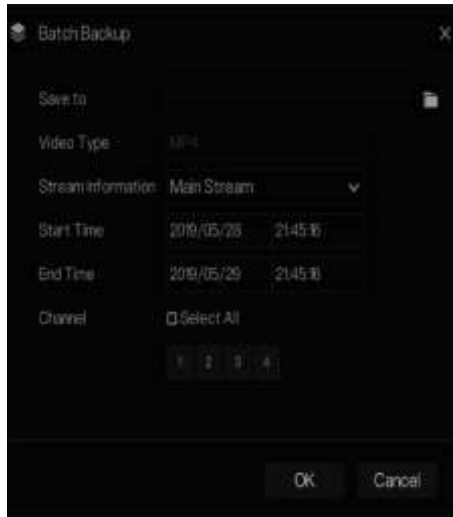

: Type of time bar, recording video can show

6.3.1 Time Search

Search refers to searching for a video by date and time.

Operation Description

Click  in the quick navigation bar to access the search screen, as shown in Figure 6-13.

Figure 6-13 Time Search screen



Operation Steps

Step 1 Select a camera in the camera list on the left side of the search screen. The video view of the selected camera is displaying in the play window.

Step 2 Select a date in the calendar on the light-down side of the search screen.

Step 3 Choose record type , and search the video quickly.

Step 4 Choose proper button to adjust video.

----End

6.3.2 Picture Grid

Picture grid refers to evenly dividing the video of a channel by time range and searching for a video based on thumbnails divided by time range.

Click **Picture Grid** on the quick navigation bar to access the picture grid screen, as shown in

Figure 6-14.

Figure 6-14 Picture grid screen



Operation Steps

Step 1 Select a camera in the camera list on the left side of the picture grid screen. Videos shot by the camera in the earliest time range on the current day are displayed as thumbnails in the window on the right side.

Step 2 Select a day from calendar.

Step 3 A day are dividend to 12 grids, two hours is one grid.

Step 4 Select a required thumbnail, double-click it or right-click it and choose Play from the shortcut menu to play the video.

----End

6.3.3 Event

Click  on the quick navigation bar; choose **event** at title to access the alarm event screen, as shown in Figure 6-15

Figure 6-15 Event screen



Operation Steps

Step 1 Select a camera in the camera list on the left.

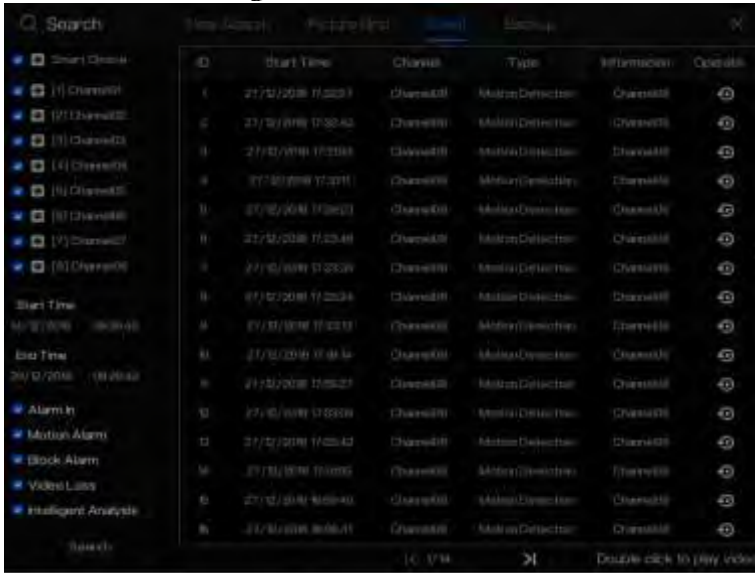
Step 2 Set start and end time.

Step 3 Tick the alarm type, such as alarm in, motion alarm, block alarm, video loss and intelligent analysis.

Step 4 Click **Search** to query the event, the result would show at window.

Step 5 Double click to play video about event. It will play recording video.

----End

6.3.4 Backup

Click  on the quick navigation bar, choose **Backup** at title to access the backup screen, as shown in Figure 6-16.

Figure 6-16 Backup screen



You can view the detail information of backup. Click delete button to quit the download.

----End

6.4 Thermal Temperature

NOTE

The thermal temperature function is only carried by some devices. If the current device does not have the function, please ignore it.

6.4.1 Temperature Parameters

Temperature parameters include: temperature unit, ambient type, ambient temperature, cavity temperature, correctional coefficient and area temperature display mode.

Operation Procedure

Step 1 Choose Thermal >Temperature Parameters.

The **Temperature Parameters** page is displayed, as shown in Figure 6-17.

Figure 6-17 Temperature Parameters interface

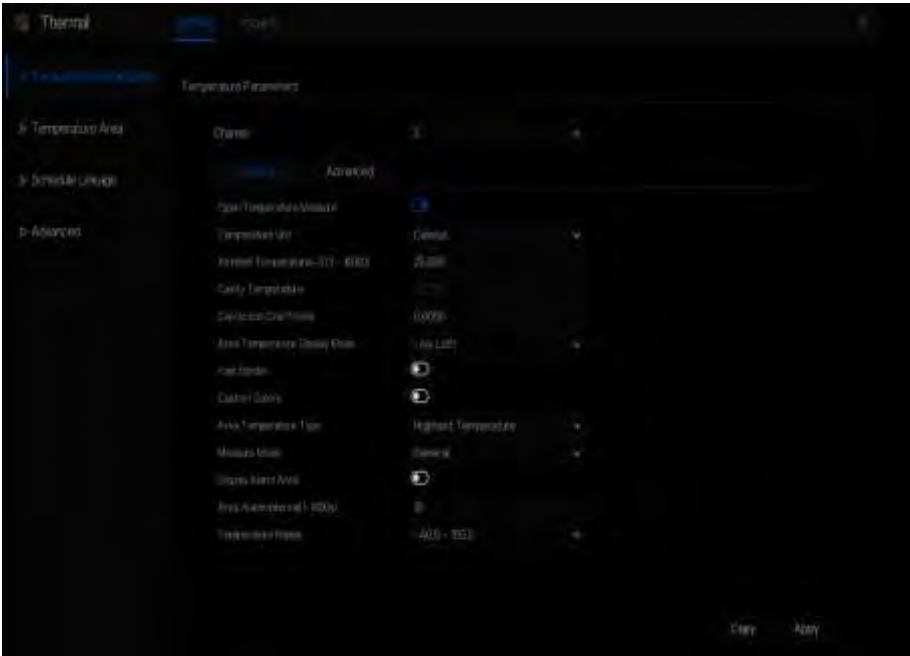

Step 2 Set the parameters according to Table 6-1.

Table 6-1 Temperature parameters

Parameter	Description	Setting
Open Temperature Measure	Enable temperature measure.	
Temperature Unit	Celsius and Fahrenheit temperature units are available.	[Setting method] Select a value from the drop-down list box. [Default value] Celsius

Parameter	Description	Setting
Ambient Temperature	The ambient temperature of camera. It is set when ambient is outside.	[Setting method] Enter a value manually.
Cavity Temperature	The cavity temperature of camera.	N/A
Correction Coefficient	Correction coefficient is refer to the deviation of measured object temperature and actual temperature. For example: 1. The measured object temperature is 30, and actual temperature is 37, so the correction coefficient should be 7 . 2. The measured object temperature is 37, and actual temperature is 30, so the correction coefficient should be -7 .	[Setting method] Enter a value manually. [Default value] 0.00
Area Temperature Display Mode	The display position of temperature information on the live-video image.	[Setting method] Select a value from the drop-down list box. [Default value] Low left

Parameter	Description	Setting
Font Border	The font will be bolded.	[Setting method] Enable or disable [Default value] disable
Custom Colors	Enable to custom the color, there are nine colors chosen.	[Setting method] Enable or disable [Default value] disable
Area Temperature Type	There are three types of area temperature.	[Setting method] Select a value from the drop-down list box. [Default value] Highest Temperature
Measure Mode	There are two types measure modes.	[Setting method] Select a value from the drop-down list box. [Default value] General
Display Alarm Area	N/A	[Setting method] Enable or disable [Default value] disable
Area Alarm Interval	N/A	[Setting method] Enter a value manually ranges from 1 to 1800. [Default value] 10

Figure 6-18 Advanced parameter



Table 6-2 Advanced parameters

Parameter	Description	Setting
Dimming Mode	There are auto and manual modes. It will show on temperature item.	[Setting method] Select a value from the drop-down list box. [Default value] Auto
Greater Prominent	Enable that, the image will show the setting color if the temperature is higher than set value.	[Setting method] Enter a value manually. Choose one color to show.

Parameter	Description	Setting
Section Prominent	Enable that, the image will show the setting color if the temperature is between minimum and maximum temperature.	[Setting method] Enter a value manually. Choose one color to show.
Less Prominent	Enable that, the image will show the setting color if the temperature is lower than set value.	[Setting method] Enter a value manually. Choose one color to show.

Step 3 Click **Copy** to copy the same settings to others thermal cameras.

Step 4 Click **Apply**.

Step 5 The message "Apply success" is displayed, the system saves the settings.

----End

6.4.2 Temperature Area

Operation Procedure

Step 1 Choose Thermal >Temperature Area.

The **Temperature Area** page is displayed, as shown in Figure 6-19

Figure 6-19 Temperature area and alarm configuration



Step 2 Set the parameters according to Table 6-3

Table 6-3 Temperature area and alarm configuration

Parameter	Description	Setting
Channel	N/A	[Setting method] Select a value from the drop-down list box. [Default value] 1
Measure Mode	Set at temperature parameter interface.	N/A

Parameter	Description	Setting
PTZ Area(only use for PTZ cameras)	Choose or set the preset, adjust the camera with PTZ keyboard. The all presets can set 20 areas to alarm	Set the preset manually, or select an existing preset in the drop-down list.
Enable	Tick to enable alarm areas.	N/A
ID	It ranges from 0 to 19.	N/A
Name	Area name of temperature area.	[Setting method] Enter a value manually.
Type	Type of temperature area. ID 0 is default rectangle area, which is full screen. There are 20 areas can be set, these are from 0 to 19 area.	[Setting method] Select a value from the drop-down list box. [Default value] Rectangle/Point
Alarm Type	Threshold alarm and Temperature difference alarm are available for alarm type.	[Setting method] Select a value from the drop-down list box. [Default value] Threshold alarm
Warning Value	Camera will warn when the surveillance object temperature reaches the warning value.	[Setting method] Enter a value manually. [Default value] 48.00
Alarm Value	Camera will alarm when the surveillance object temperature reaches the alarm value.	[Setting method] Enter a value manually. [Default value] 50.00

Parameter	Description	Setting
Maximum Alarm Value	The maximum value of the alarm range, if the alarm value is exceeded, no alarm will be generated.	[Setting method] Enter a value manually. [Default value] 60.00
Emission Rate	The emission rate is the capability of an object to emit or absorb energy. The emission rate should be set only when the target is special material.	[Setting method] Enter a value manually. [Default value] 0.95
Distance(M)	The distance between camera and target.	[Setting method] Enter a value manually. [Default value] 15  NOTE Enter actual distance when the distance between camera and target is less than 15 m. Enter 15 when the distance between camera and target is great than or equal to 15 m.
Alarm	Open or close the alarm output and linkage of area.	[Setting method] Tick the alarm areas

Step 3 Set temperature area.

1. Tick an area ID.
2. Select type from drop-list.
3. Press and hold the left mouse button, and drag in the video area to draw a temperature area. Right-click to finish the area selected.

4. Click **Apply**, the message “Apply success” is displayed, the temperature area is set successfully.

Delete a temperature area:

1. Select an area ID.
2. Click the temperature area and right-click.
3. Remove the tick of area ID.
4. Click **Apply**, the message “Apply success” is displayed, the temperature area is deleted successfully.

Step 4 Click **Apply**.

Step 5 The message "Apply success" is displayed, the system saves the settings.

----End

6.4.3 Schedule Linkage

Operation Procedure

Step 1 Choose Thermal > Schedule Linkage

The **Schedule Linkage** page is displayed, as shown in Figure 6-20.

Figure 6-20 Schedule Linkage

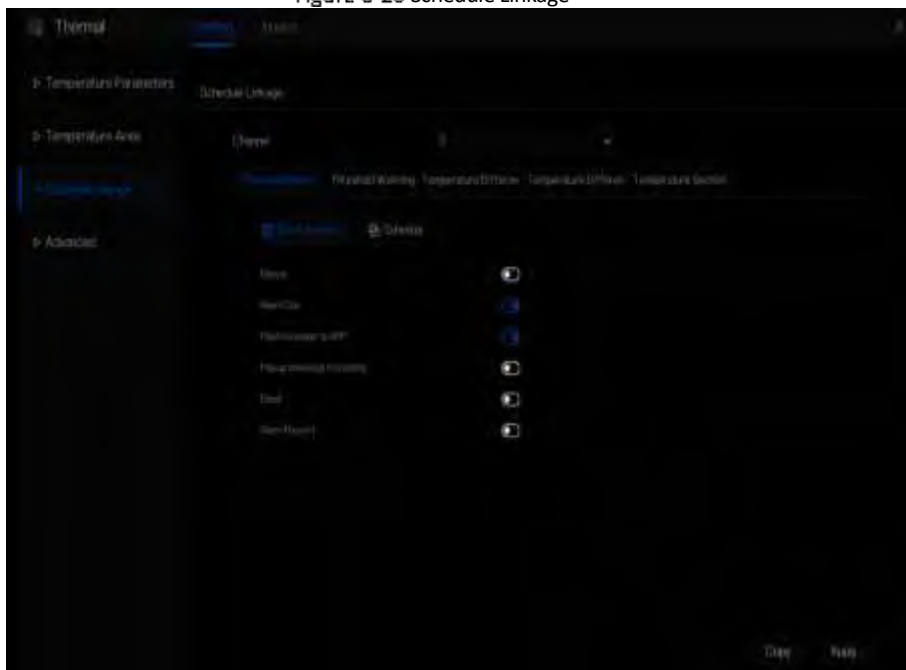

Step 2 Tick the output channel.

Step 3 Enable “Alarm Record”, “E-mail” button.

Step 4 Set schedule linkage.

Figure 6-21 Schedule



Method 1: Click left mouse button to select any time point within 0:00-24:00 from Monday to Sunday as shown in Figure 6-20.

Method 2: Hold down the left mouse button, drag and release mouse to select the alarm time within 0:00-24:00 from Sunday to Saturday.

 **NOTE**

When you select time by dragging the cursor, the cursor cannot be moved out of the time area. Otherwise, no time can be selected.

Method 3: Click  in the alarm time page to select the whole day or whole week.

Deleting alarm time: Click  again or inverse selection to delete the selected alarm time.

Step 5 Click **Apply**.

Step 6 The message "Apply success" is displayed, the system saves the settings.

----End

6.4.4 Advanced

Operation Procedure

Step 1 Choose **Thermal > Advanced** to enter the advance interface, as shown in Figure 7-1.

Figure 6-22 Advanced

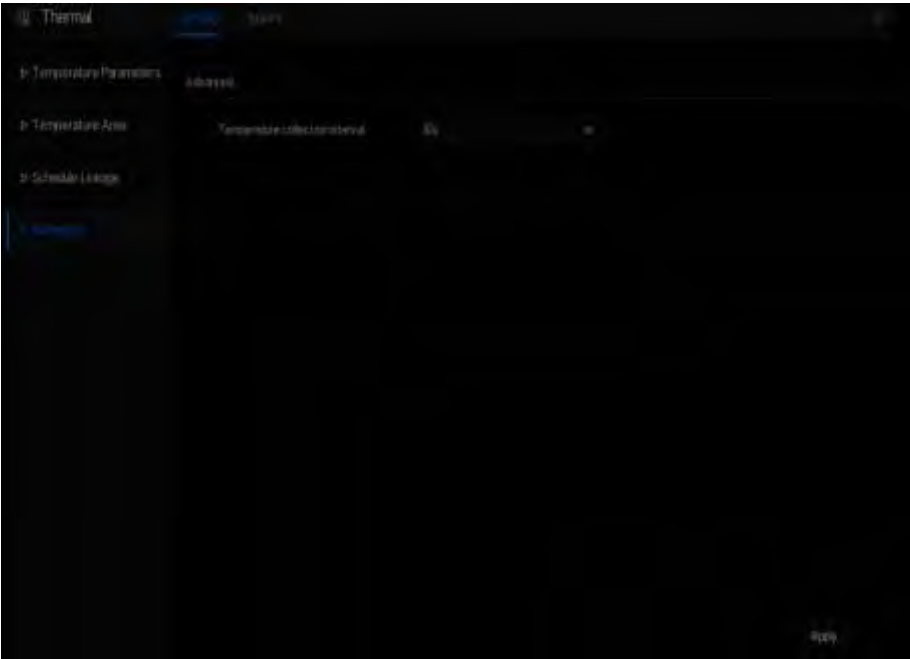

Step 2 Select the temperature collection interval from the drop-list.

Step 3 Click **Apply**.

Step 4 The message "Apply success" is displayed, the system saves the settings.

----End

6.4.5 Inquire

Operation Procedure

Step 1 Choose **Thermal** > **Inquire** to enter the inquire interface, as shown in Figure 6-23.

Figure 6-23 Inquire

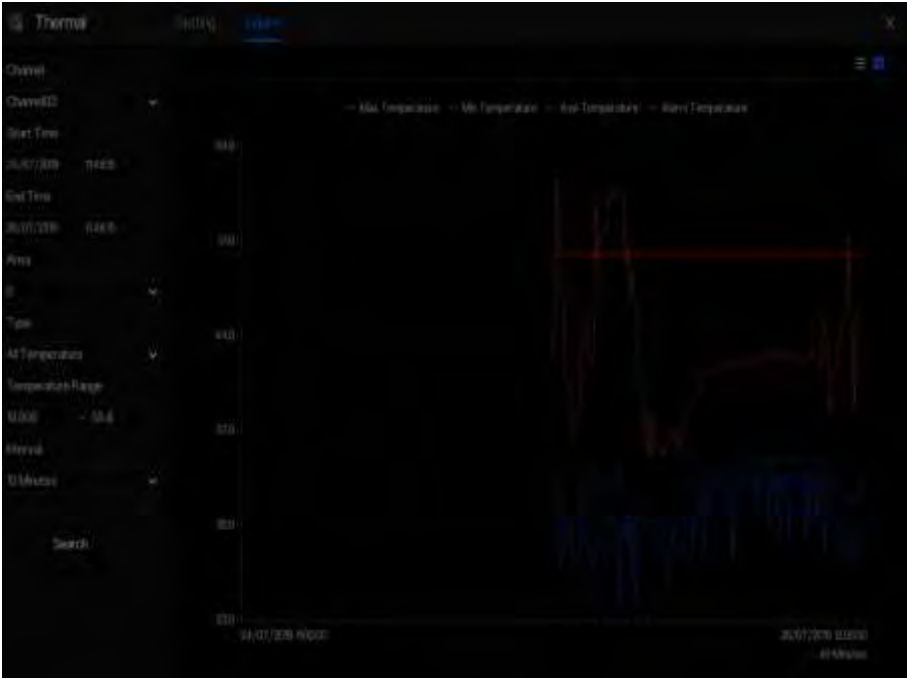

Step 2 Choose the channel is thermal camera.

Step 3 Set the start and end time.

Step 4 Choose the area, which is set at the temperature area interface. The default area is 0(full screen).

Step 5 Choose the type of temperature, set the temperature range.

Step 6 Choose the interval of showing, click **Search** to show the result, there are two modes to show result, list or picture.

6.5 Attendance

The function only be used for NVR2604E1-P4C-J and NVR2608E1-P8C-J

6.5.1 Attendance Data

Click to enter attendance data interface, as shown in Figure 6-24.

Figure 6-24 Attendance data

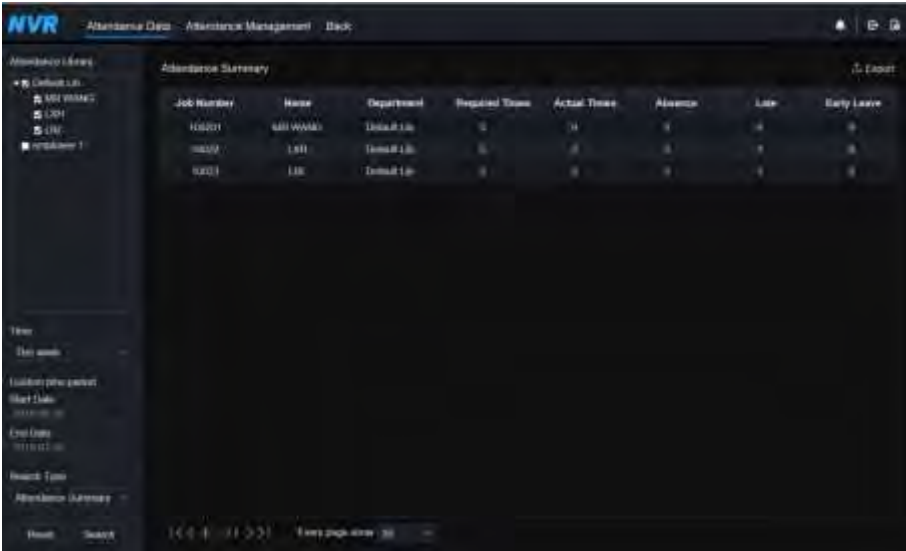

The screenshot shows the NVR Attendance Data interface. The main content is an 'Attendance Summary' table with the following data:

Job Number	Name	Department	Required Time	Actual Time	Absence	Late	Early Leave
10001	ALI WAKI	Default Lab	0	0	0	0	0
10002	ALI	Default Lab	0	0	0	0	0
10003	ALI	Default Lab	0	0	0	0	0

The interface also includes a sidebar with navigation options like 'Attendance Library', 'Time', 'Attendance Summary', and 'Export'. The top navigation bar shows 'Attendance Data - Attendance Management - Back'.

Operation Steps

Step 1 Tick the attendance library.

Step 2 Choose time mode, such as today, this week, this month and custom time.

Step 3 Choose search type, such as attendance summary and attendance details.

Step 4 Click search, the result will show in interface.

Step 5 Click Export to export the query result.

6.5.2 Attendance Management

In attendance management, user can set attendance rule, library and check point, as shown in Figure 6-25.

Figure 6-25 Attendance rule settings



Operation Steps

- Step 1 Set start work time and end work time.
- Step 2 Tick the workday
- Step 3 Set valid time of check in and check out.
- Step 4 Click Save to save the setting.

Attendance library

- Step 1 Click **Attendance Library** to add library, the attendance library can call the face database directly.

Figure 6-26 Attendance library



Step 2 Tick the library and click Add to add to attendance library. If you want to modify the library.

Step 3 click  Database management to enter the face database management to modify parameter.

Step 4 Click Save to save the setting.

Attendance check point settings:

Step 1 Click **Attendance check point** settings to set point, as shown in Figure 6-27.

Figure 6-27 Attendance check point setting



Step 2 Click  to edit check point setting, as shown in Figure 6-28

Figure 6-28 Check point



Step 3 Enable the function, set similarity and tick the library, all face detection cameras can be set the check points

Step 4 Click **OK** to save the setting.

---End

6.6 AI Recognition

At AI recognition interface, we can set the **Real time Comparison, Smart search, Archives library, Comparison configuration.**

6.6.1 Real Time Comparison

Real time comparison can compare human faces, vehicle license plate, and AI(include riding, vehicle, full body)

6.6.1.1 Human Face



At real time comparison interface, click the  to enter the human face comparison interface, choose the cameras with face recognition function to play live video, the snapshots of camera will compare in libraries, the result shows as in Figure 6-29.

Figure 6-29 Human face comparison

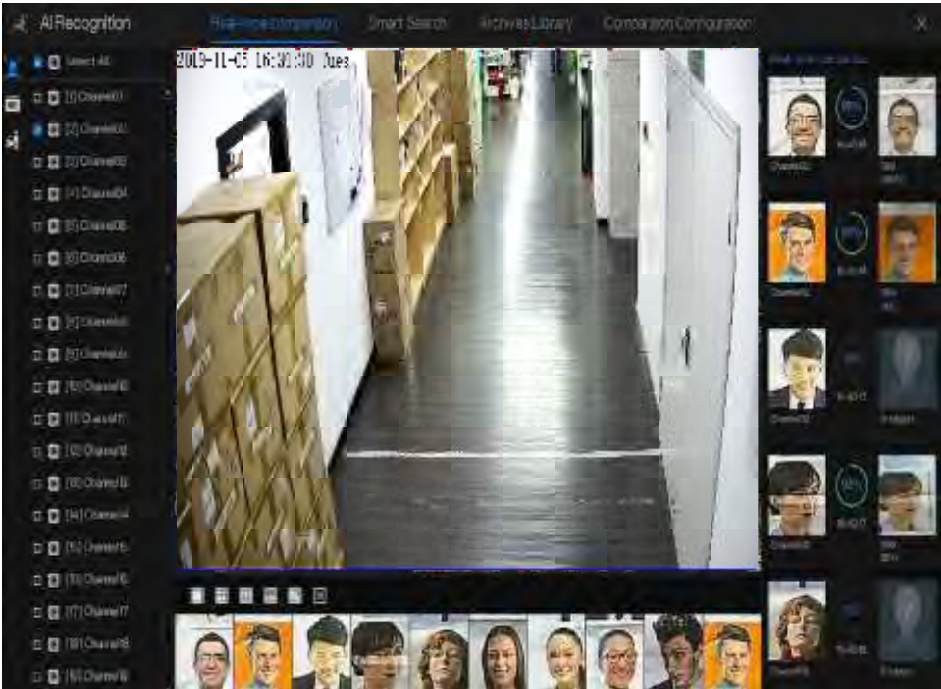

Click the “+” can add the snapshot to face library immediately.

Snapshot in real time video, put the cursor on picture such as , you can add it to face library, or face search. The cursor on area 6 and the pictures is not update, move the mouse so that the pictures can be shown in time.

6.6.1.2 Vehicle License Plate

At real time comparison interface, click the **NO.** to enter the vehicle license plate comparison interface, choose the cameras with license plate recognition function to play live video, the snapshot of camera will compare with libraries, the result shows as in Figure 6-30.

Figure 6-30 Vehicle license plate



Click the “+” can add the snapshot to license plate library immediately.

6.6.1.3 Vehicle and Full Body

At real time comparison interface, click the **NO.** to enter the vehicle license plate comparison interface, choose the AI recognition cameras to play live video, the snapshot of camera will compare in libraries, the snapshot to vehicle and full body will show at the bottom of page, the result shows as in Figure 6-31.

Figure 6-31 Full body



6.6.2 Smart Search

At smart search interface, user can search the human face, vehicle license plate, full body, car, body temperature.

6.6.2.1 Human Face Search

Figure 6-32 Human face search

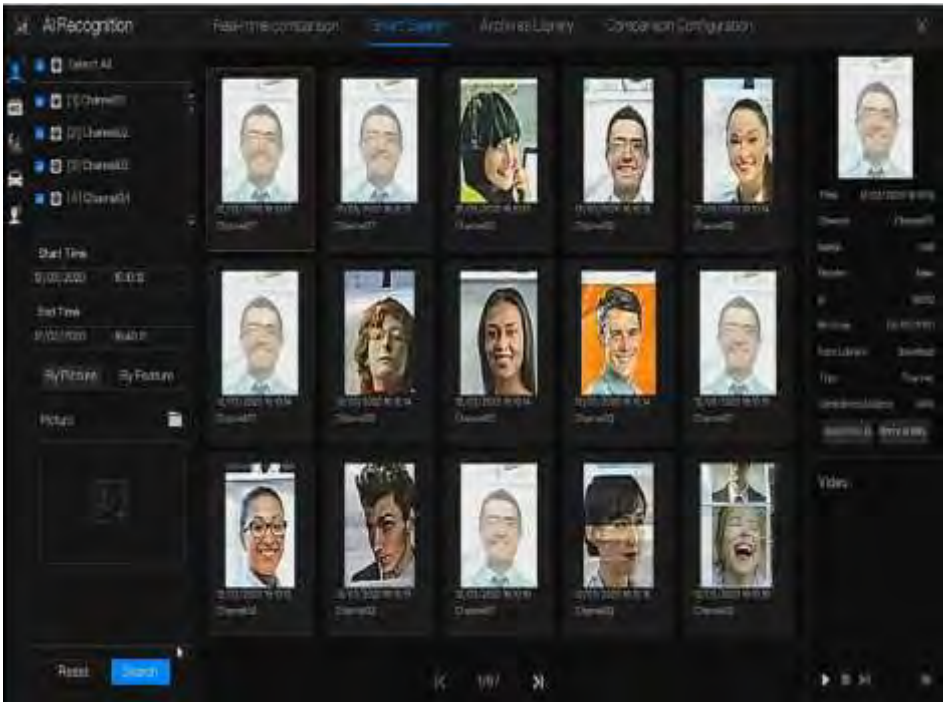

Step 1 Choose human face search at smart search interface.

Step 2 Tick the face recognition camera channels, set the start time and end time.

Step 3 Choose the condition (by picture or by feature), the picture can be chosen from the file folder.

Step 4 Click "Search" to search the snapshot of human face.

Step 5 The result will show at the middle of page, click the picture and the detail information will show at the top right of page.

Step 6 The detail picture can be used to search or add to library.

Step 7 Click play button of video to play the recording of snapshot.

Play video of snapshot, it will play a 30-second video before and after the snapshot.

Snapshot in real time video, put the cursor on picture such as , you can add it to face library, or face search. The cursor on area 6 and the pictures is not update, move the mouse so that the pictures can be shown in time.

6.6.2.2 Vehicle License Plate Search

Figure 6-33 Vehicle License Plate search

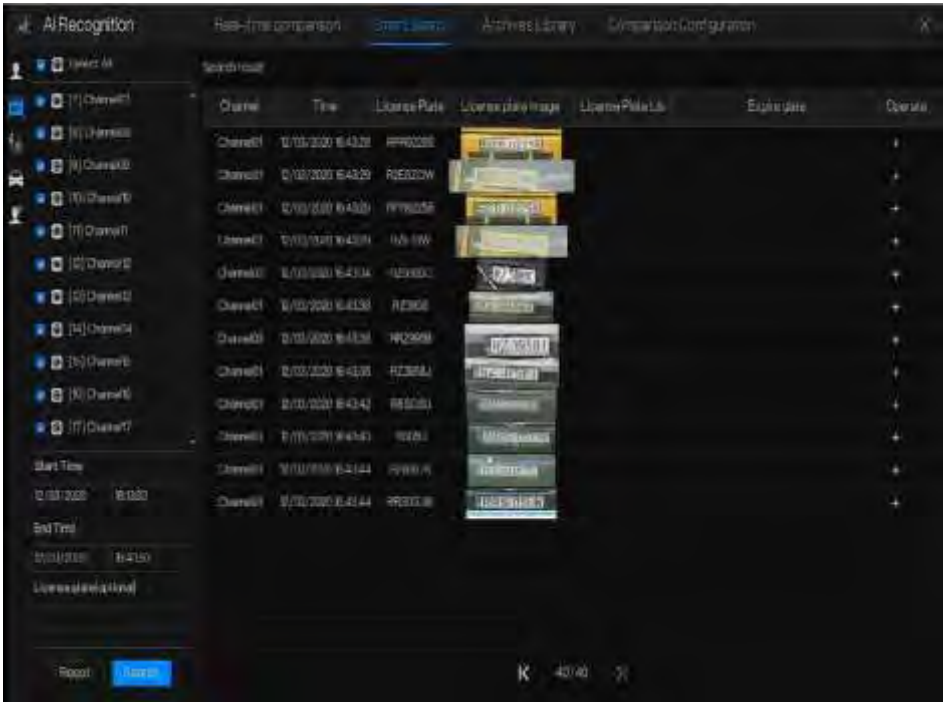

- Step 1 Choose vehicle License Plate at smart search interface.
- Step 2 Tick the vehicle license plate recognition camera channels, set the start time and end time.
- Step 3 Input the license plate optionally.
- Step 4 Click “Search” to search the snapshot of license plate.
- Step 5 The result will show at the page, click “+” add to library.

6.6.2.3 Full Body Search

Figure 6-34 Full body search

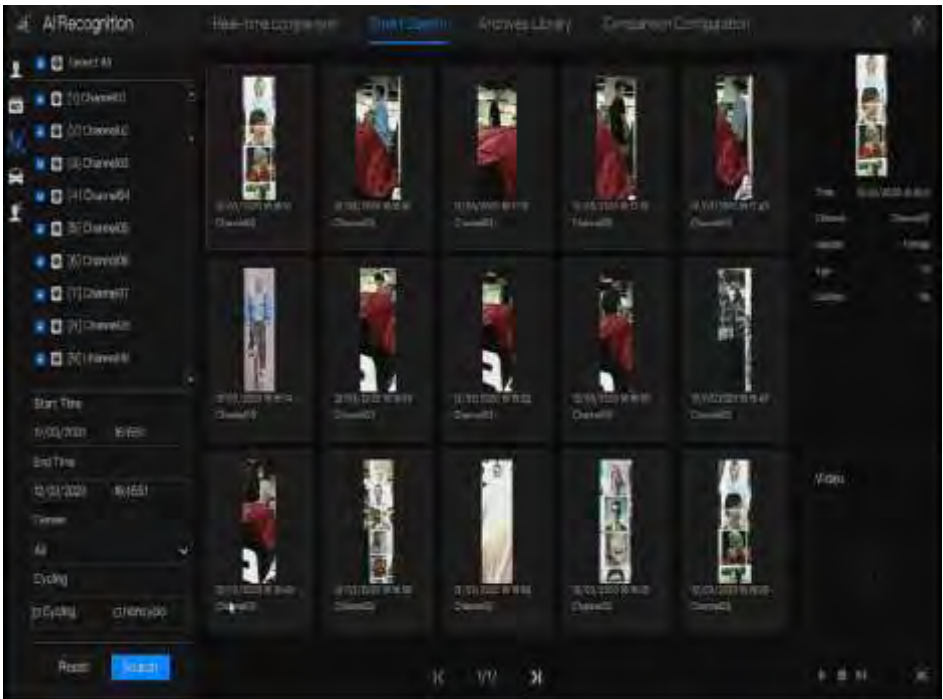

- Step 1 Choose full body search at smart search interface.
- Step 2 Tick the AI recognition camera channels, set the start time and end time.
- Step 3 Set the gender , click cycling or no cycling .
- Step 4 Click “Search” to search the snapshot of human face.
- Step 5 The result will show at the middle of page, click the picture and the detail information show at the top right of page.
- Step 6 Click play button of video to play the recording of snapshot.

6.6.2.4 Vehicle Search

Figure 6-35 Vehicle search

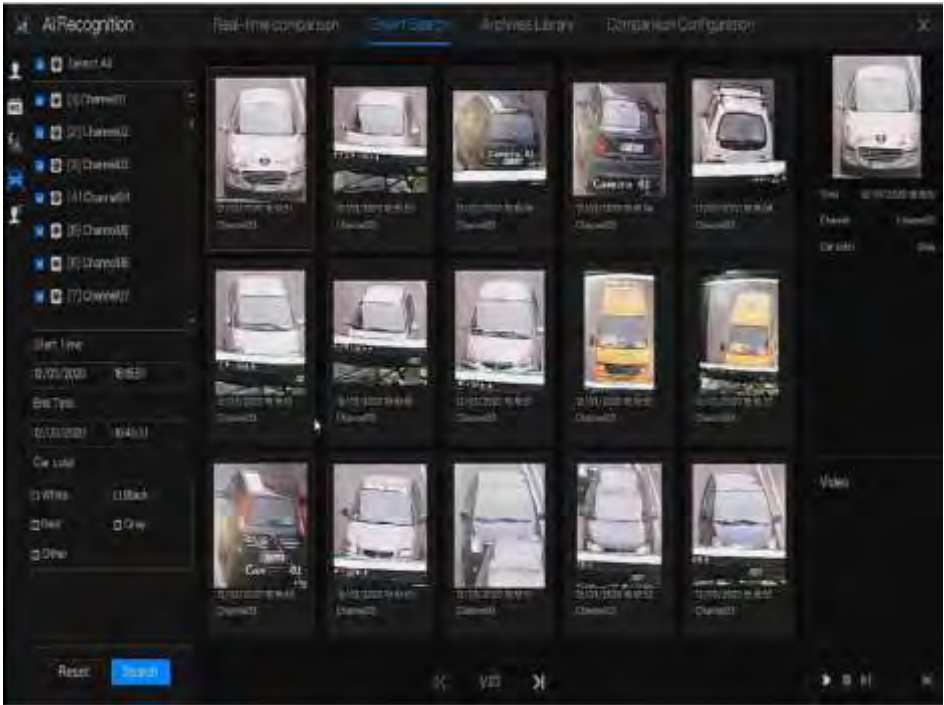

Step 1 Choose vehicle search at smart search interface.

Step 2 Tick the AI recognition camera channels, set the start time and end time.

Step 3 Tick the color

Step 4 Click “Search” to search the snapshot of human face.

Step 5 The result will be showed at the middle of page, click the picture and the detail information show at the top right of page.

Step 6 Click play button of video to play the recording of snapshot.

6.6.2.5 Body Temperature Search

Figure 6-36 Body temperature search

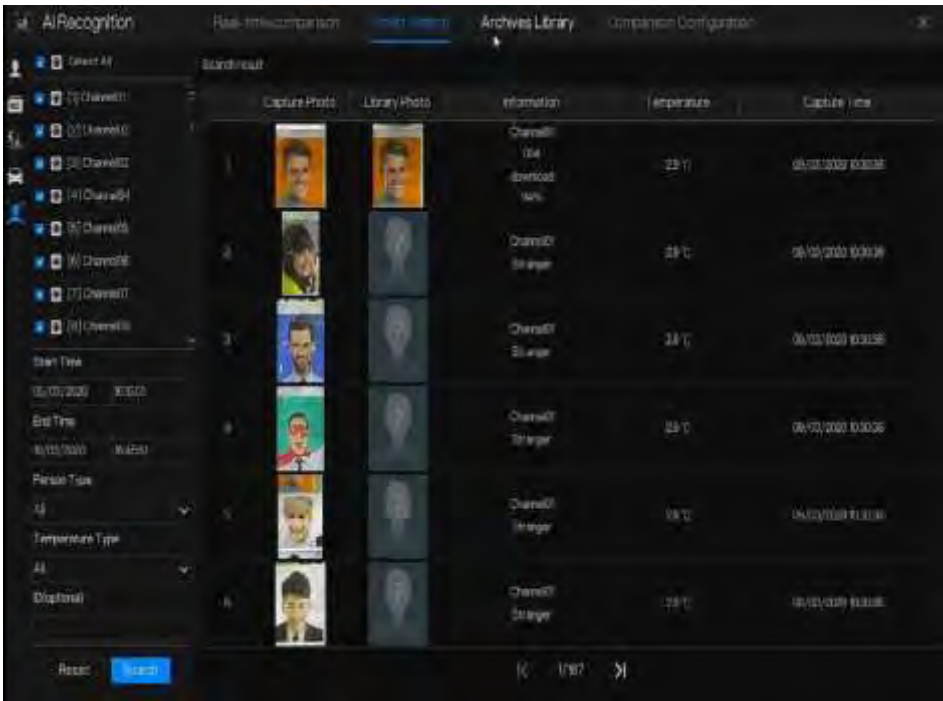

Step 1 Choose body temperature search at smart search interface.

Step 2 Tick the AI recognition camera channels, set the start time and end time.

Step 3 Choose the person type, temperature type, input ID optionally.

Step 4 Click “Search” to search the temperature.

6.6.3 Archives Library

At archives library, user can add or edit the face library , license plate library.

6.6.3.1 Face Library

Figure 6-37 Face library

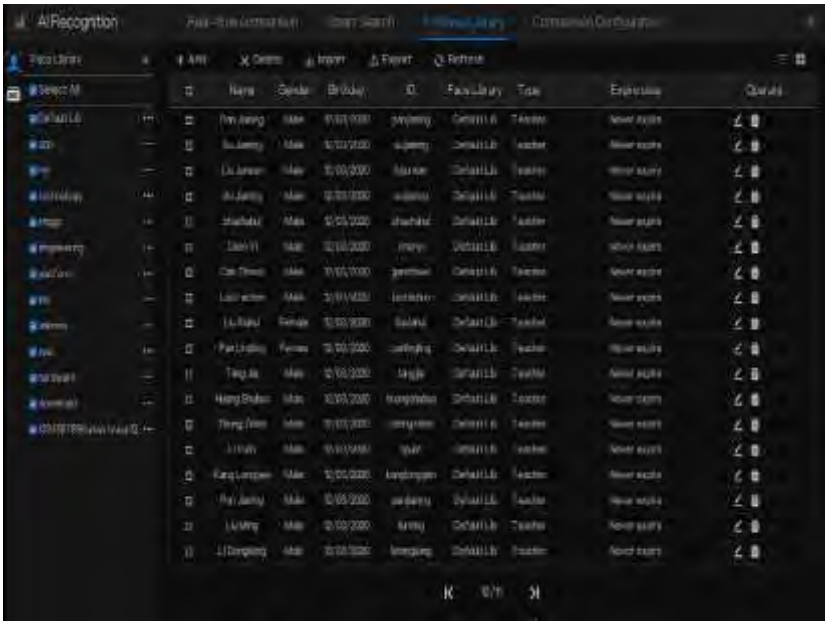

- Click “+” to add face library.
- Click “Add” to add person enroll.
- Tick the person, click “Delete” to delete the person.
- Click “Import” to add the person batch.
- Click “Export” to export the all person in library.
- Click operate icon to edit or delete the chosen person.

6.6.3.2 License Plate Library

Figure 6-38 License plate library

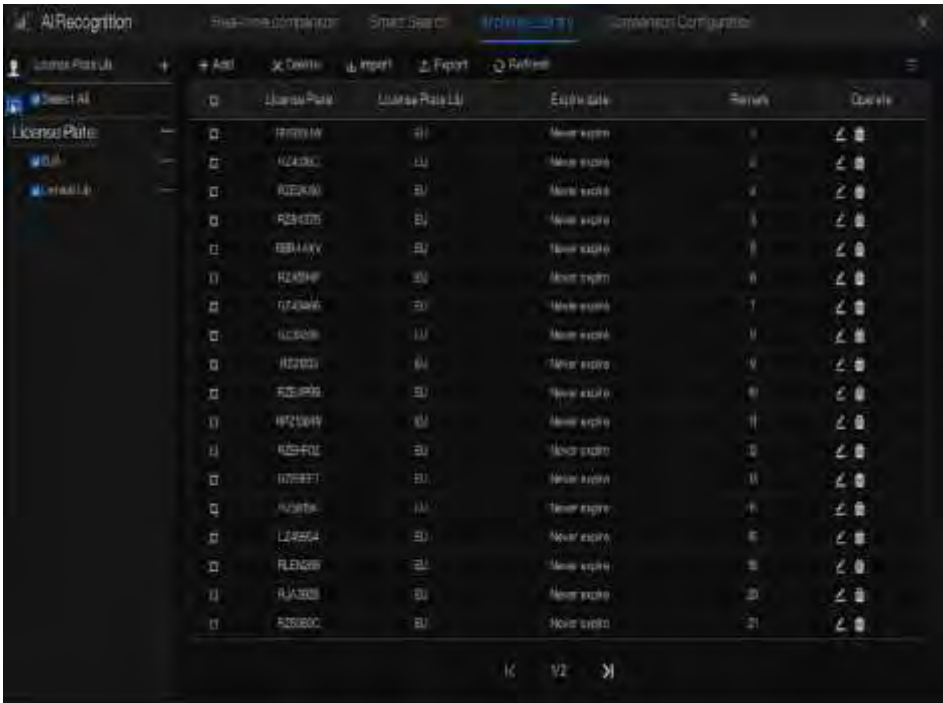

Click “+” to add license plate library.

Click “Add” to add plate to library.

Tick the plate , click “Delete” to delete the license plate.

Click “Import” to add the license plate batch.

Click “Export” to export the all license plate library.

Click operate icon to edit or delete the chosen license plate.

6.6.4 Comparison Configuration

At comparison configuration interface, user can set the comparison of human face/ license plate/temperature.

Figure 6-39 Face comparison



The screenshot shows a software interface titled "AI Recognition" with a dark theme. It features a table with columns for Channel, Register Default Library, Original Default Library, Similarity, and Strategy. The table lists 20 channels, each with a similarity percentage and a strategy icon.

Channel	Register Default Library	Original Default Library	Similarity	Strategy
Channel1	Default1.B	Default1.B	95%	⚡
Channel2	Default1.B	Default1.B	95%	⚡
Channel3	Default1.B	Default1.B	95%	⚡
Channel4	Default1.B	Default1.B	95%	⚡
Channel5	Default1.B	Default1.B	95%	⚡
Channel6	Default1.B	Default1.B	95%	⚡
Channel7	Default1.B	Default1.B	95%	⚡
Channel8	Default1.B	Default1.B	95%	⚡
Channel9	Default1.B	Default1.B	95%	⚡
Channel10	Default1.B	Default1.B	95%	⚡
Channel11	Default1.B	Default1.B	95%	⚡
Channel12	Default1.B	Default1.B	95%	⚡
Channel13	Default1.B	Default1.B	95%	⚡
Channel14	Default1.B	Default1.B	95%	⚡
Channel15	Default1.B	Default1.B	95%	⚡
Channel16	Default1.B	Default1.B	95%	⚡
Channel17	Default1.B	Default1.B	95%	⚡
Channel18	Default1.B	Default1.B	95%	⚡
Channel19	Default1.B	Default1.B	95%	⚡
Channel20	Default1.B	Default1.B	95%	⚡

At face comparison interface, user can set different channels' strategy, such as similarity, display comparison result, face library, enable alarming, event action, arming time, as shown in Figure 6-39 .

Figure 6-40 License comparison

Channel	Register license strategy	Unregister license strategy	Alarm
Channel1	Default LB	Default LB	Default LB
Channel2	Default LB	Default LB	Default LB
Channel3	Default LB	Default LB	Default LB
Channel4	Default LB	Default LB	Default LB
Channel5	Default LB	Default LB	Default LB
Channel6	Default LB	Default LB	Default LB
Channel7	Default LB	Default LB	Default LB
Channel8	Default LB	Default LB	Default LB
Channel9	Default LB	Default LB	Default LB
Channel10	Default LB	Default LB	Default LB
Channel11	Default LB	Default LB	Default LB
Channel12	Default LB	Default LB	Default LB
Channel13	Default LB	Default LB	Default LB
Channel14	Default LB	Default LB	Default LB
Channel15	Default LB	Default LB	Default LB
Channel16	Default LB	Default LB	Default LB
Channel17	Default LB	Default LB	Default LB
Channel18	Default LB	Default LB	Default LB
Channel19	Default LB	Default LB	Default LB
Channel20	Default LB	Default LB	Default LB

At license plate interface, use can set strategies of different channels of license plate recognition cameras, such as register and unregister, enable alarming, event action, arming time, as shown in Figure 6-40.

Figure 6-41 Temperature comparison

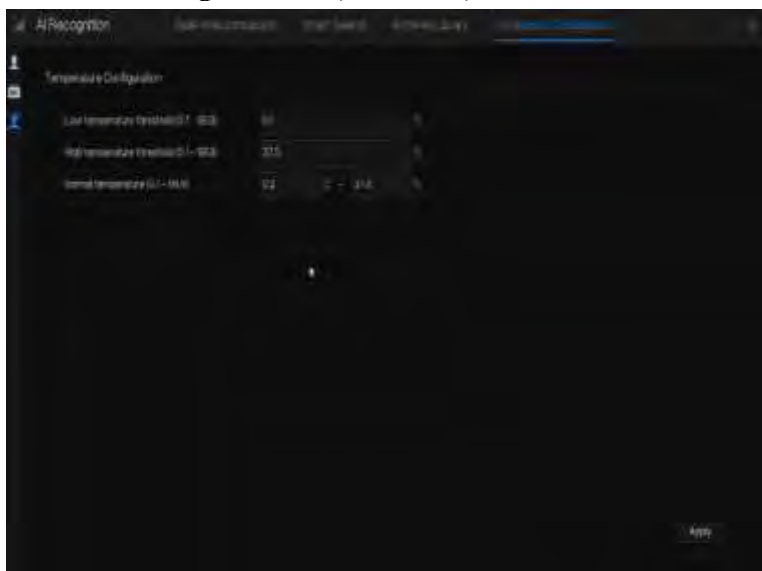

At temperature comparison interface, user can set low temperature threshold, high temperature threshold, normal temperature, as shown in Figure 6-41.

Figure 6-42 Strategy



7 UI System Setting

7.1 Channel Information

Click the  will show as Figure 7-1, tick the Channel or Encode, the information will show in live video screen.

Figure 7-1 Channel information



7.2 Main Menu

Right-click on UI screen, the main menu as shown in Figure 7-2. The main menu includes **Channel, Record, Network, Alarm** and **System**.

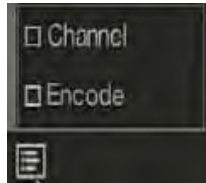
Figure 7-2 NVR main menu



----End

7.3 Channel Management

IP cameras can directly connect to input channels of the NVR by plugging in POE port. When IP cameras are insufficient, the NVR can automatically searches for and adds IP cameras or manually add cameras in the same Local Area Network (LAN).

Channel management includes add or delete **Camera**, **Encode**, **Sensor Setting**, **OSD** and **Privacy Zone**.

7.3.1 Camera

Operation Description

Click **Channel** in the main menu to access the camera management screen, as shown in Figure 7-3 .

Figure 7-3 Channel management screen

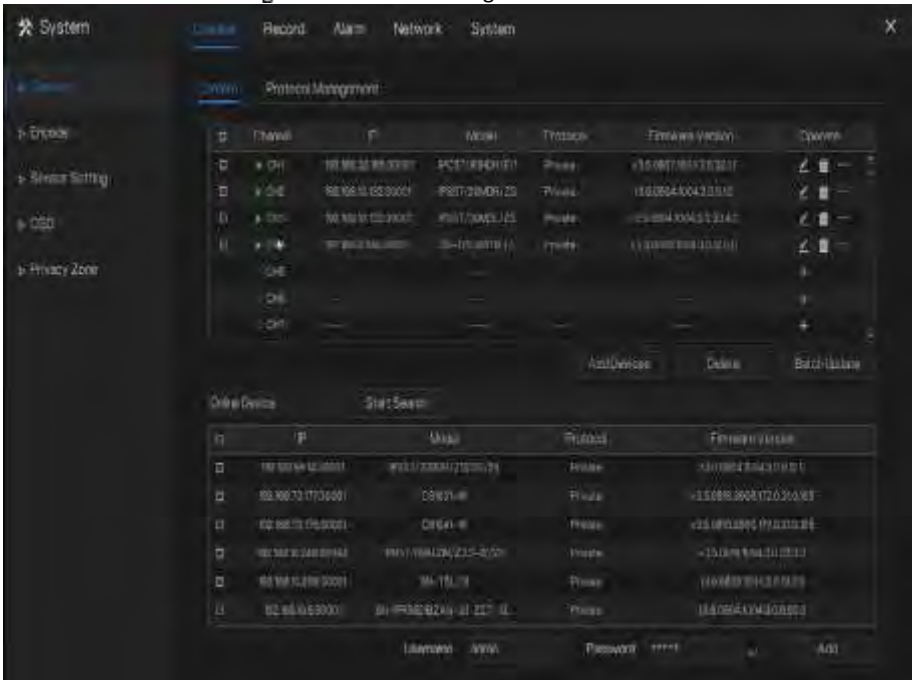

7.3.1.1 Add Camera Automatically

The NVR can add automatically cameras to the camera list.

Operation Methods

Method 1: Click  button, the cameras these are the same local subnet with NVR



will show in list, input username and password (the default value both are admin)click

, the cameras in the list would be added to channels directly.

Method 2: Select the cameras you wanted to add, and click  the selected cameras would be added to the camera list.

Tick the online non-onvif channels at list and click  to access the directory of software; it would to update the channels at once.

NOTE

- On the camera management screen, check the status of channel in the camera list. If the status of a channel is , this camera is online. If the status of a channel is , this camera is offline.
- The added cameras should be the same subnet segment as NVR.

7.3.1.2 Add Camera Manually

Operation Steps



Step 1 Click , the screen to add devices manually is displaying, as shown in Figure 7-4.

Figure 7-4 Add camera screen

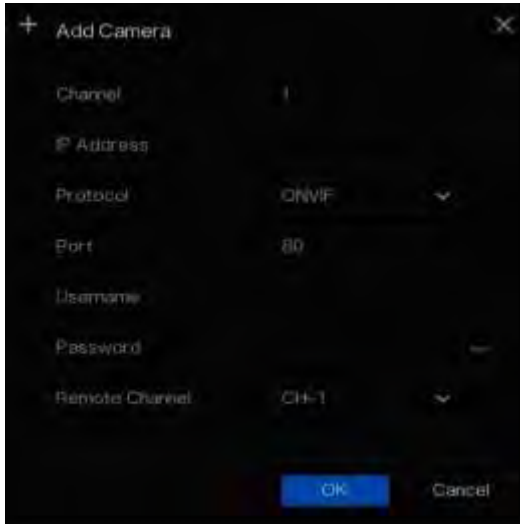

Step 2 Input IP address, port, user name and password of camera.

Step 3 Select a protocol from the drop-down list(ONVIF, Private, custom protocols). Remote channel is only used for thermal imaging cameras.

Step 4 Click , the camera is added successfully.



NOTE

If all channels of the NVR are connected by cameras, please delete the cameras that you don't need , so that you can add more cameras.

If an IP camera is added manually, input the correct username and password of the camera below the online device list. The camera will be added successfully. If not the camera would be shown on list at offline.

The protocol can be chosen the custom protocols these are set at protocol interface.

7.3.1.3 Add Camera by RSTP

If the user want to add the different protocol cameras to NVR, you can set the protocol management, and add cameras one by one, as shown in Figure 7-5.

Figure 7-5 Protocol management

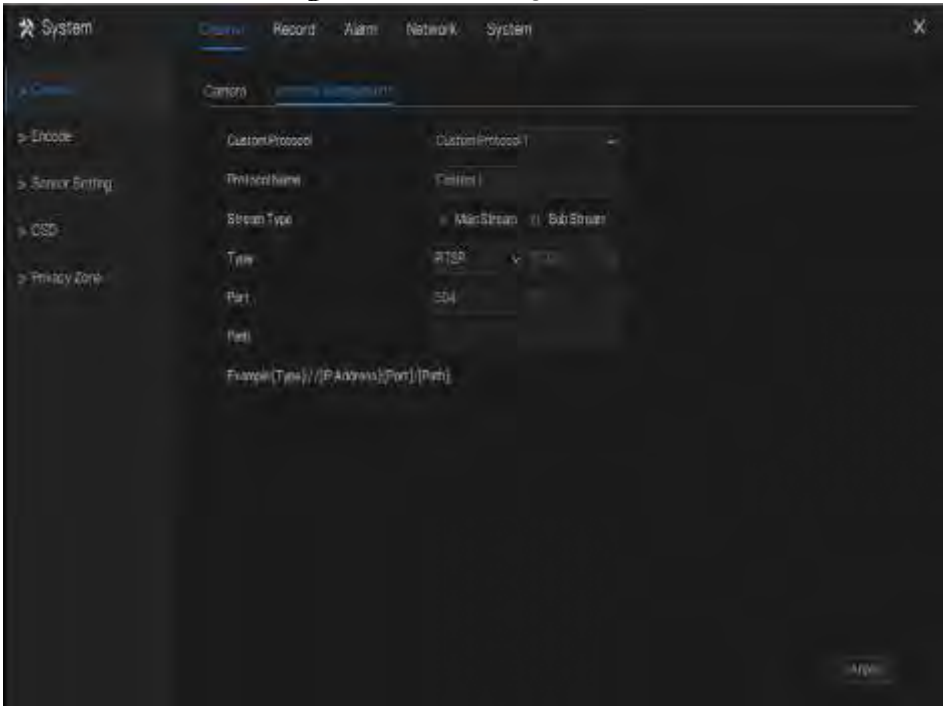

Step 1 Click **Channel > Camera > Protocol Management**.

Step 2 Choose the custom protocol from the drop-down list, there are 16 kinds of protocols can be set.

Step 3 Input the protocol name.

Step 4 Tick main stream and sub stream. The main stream shows image on full screen live video.

The sub stream shows image on split screen. If you just tick main stream and the channel will not show image on split screen.

Step 5 Choose the type of protocol, the default value is RTSP.

Step 6 Input the port, it depends the IP camera.

Step 7 Input the path, it depends the manufacturer of cameras.

Step 8 Click Apply to save the settings.

NOTE

Choose the protocol from the drop-down list, the protocol is set at protocol management interface. The cameras should be confirmed to the protocols.

7.3.1.4 Delete Camera

Operation Steps



Step 1 Select a camera to delete in the camera list and click  , the delete confirmation message screen is displaying, as shown in Figure 7-1.

Figure 7-1 Delete confirmation message

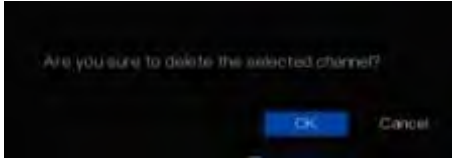

Step 2 Click  , the camera will be deleted successfully.

7.3.1.5 Operate Camera

At camera list, click  to operate camera as shown in Figure 7-2, user can update, reboot and reset the camera immediately.

Figure 7-2 More operation



Step 1 Click **Update**, pop-up window to select software, as shown in Figure 7-3.

Step 2 Set the directory click  to update camera.

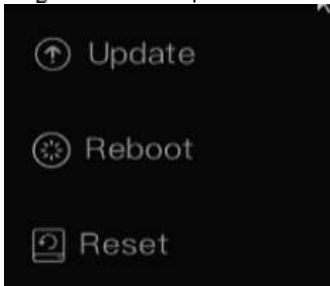
Figure 7-3 Select directory of software

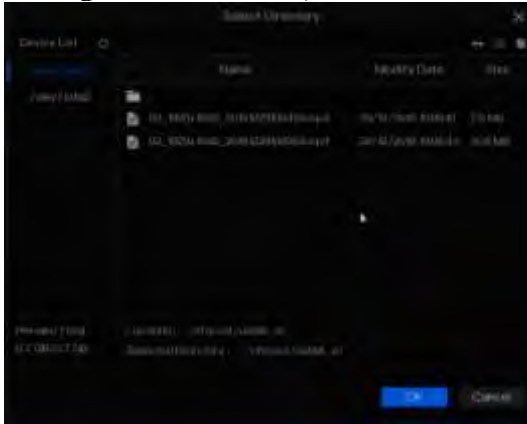

Step 3 Click **Reboot**, message “**Are you sure to reboot?**” would show, click **OK** to reboot the camera.

Step 4 Click **Reset**, message “**Are you sure to reset?**” would show, user can enable the retain IP address function. click **OK** to reset the camera.

Step 5 Tick the cameras with non-onvif protocol and cameras are online, click **Update** to update all cameras at once.



NOTE

Update need upload the firmware by flash driver.

7.3.2 Encode Parameter

The system allows setting the stream information, encoding type, resolution, frame rate, bitrate control, bitrate and quality for cameras in a channel in **Encode Parameter** screen.

Operation Description

Click **Encode** in the main menu or **Menu** of the channel management screen and choose **Encode** to access the **Encode** screen, as shown in Figure 7-4.

Figure 7-4 Encode screen



Operation Steps

Step 1 Select a channel from the drop-down list of channel.

Step 2 Select stream information.

Step 3 Select encode type (video and audio), resolution, frame rate, bitrate type and bitrate size from the drop-down lists.

Step 4 Click **Copy** and select channels or tick **all**, then click **OK** to apply the parameter settings to cameras in selected channels, click **Apply** to save encode parameter settings.

----End

7.3.3 Sensor Setting

Sensor setting refer to basic attributes of pictures, it includes the brightness, sharpness, contrast and saturation. You can set picture parameters for each channel based on scene.

Operation Description

Click **Sensor Setting** in the main menu or click menu of the channel management screen and choose **Sensor Setting** to access the Sensor Setting screen, as shown in Figure 7-5.

Figure 7-5 Sensor setting screen



The Sensor Setting are as follows:

- Brightness: it indicates brightness or darkness of picture.
- Sharpness: it indicates picture's clarity.
- Contrast: it refers to the brightest white and darkest black in an image.
- Saturation: it indicates brilliance of the picture color.

Other parameters are sensor settings of IP cameras, like scene, exposure, white balance, day-night, noise reduction, enhance image, zoom focus, etc.

- Scene: it includes indoor, outdoor, default. Mirror includes normal, horizontal, vertical, horizontal + vertical.
- Exposure: it includes mode, max shutter, meter area and max gain.
- White balance: it includes tungsten, fluorescent, daylight, shadow, manual, etc.
- Day-night: user can transit day to night, or switch mode.
- Noise reduction: it includes 2D NR and 3D NR.
- Enhance image: it includes WDR, HLC, BLC, defog and anti-shake.

- Zoom focus: user can zoom and focus.

Operation Steps

Step 1 Select a channel from the drop-down list of channel.

Step 2 Select scene from the drop-down list. The default values of picture parameters vary with scenarios.

Step 3 Set parameters.

Step 4 Click **Default** to reset to factory settings, click **Apply** to save image settings.

----End

7.3.4 OSD Settings

Click **OSD** in the main menu or menu of the channel management screen and choose **OSD** to access the OSD screen, as shown in Figure 7-6.

Figure 7-6 OSD setting screen

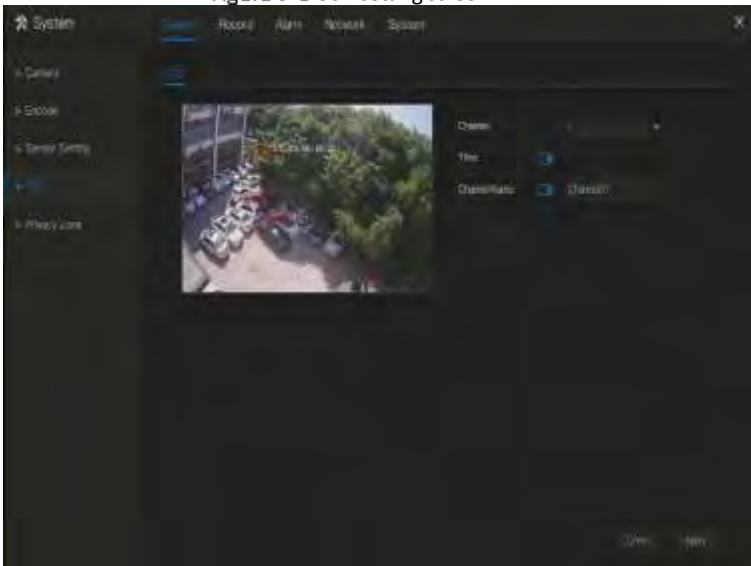

Operation Steps

Step 1 Select a channel from the drop-down list of channel.

Step 2 Click  next to Time to enable or disable OSD time setting.

Step 3 Click  next to Name to enable or disable OSD channel setting.

Step 4 Set the channel name.

Step 5 In the video window, click and drag time or channel to move to a location.

Step 6 Click **Copy** and select channels, then click **OK** to apply the OSD settings to cameras in selected channels , click **Apply** to save OSD settings.

----End

7.3.5 Privacy Zone

The system allows you to mask images in a specified zone and this zone is called privacy zone.

Operation Description

Click **Privacy Zone** in the main menu or menu of the channel management screen and choose privacy zone to access the **Privacy Zone** screen, as shown in Figure 7-7.

Figure 7-7 Privacy zone screen

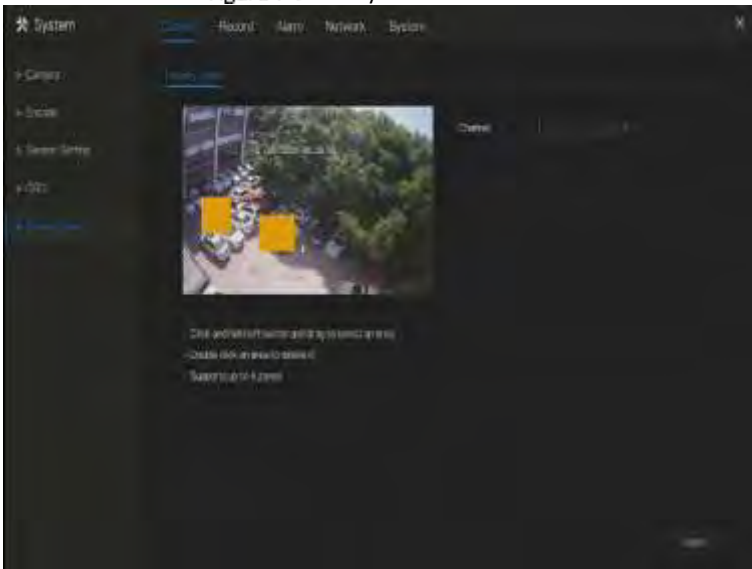

Operation Steps

Step 1 Select a channel from the drop-down list of channel.

Step 2 In the video window, hold down and drag the left mouse button to draw a privacy area.

Step 3 Click **Copy** and select channels or tick **all**, then click **OK** to apply the privacy settings to cameras in selected channels , click **Apply** to save privacy settings.

Step 4 Double click privacy area to delete setting.

---End

7.4 Record Setting

Set the **Record Schedule**, view the disk capacity, examine the record' status.

7.4.1 Record Schedule

Operation Description

Click **Record** in the main menu or click the record page of any function screen in the main menu to access the record schedule screen, as shown in Figure 7-8.

Figure 7-8 Record management screen

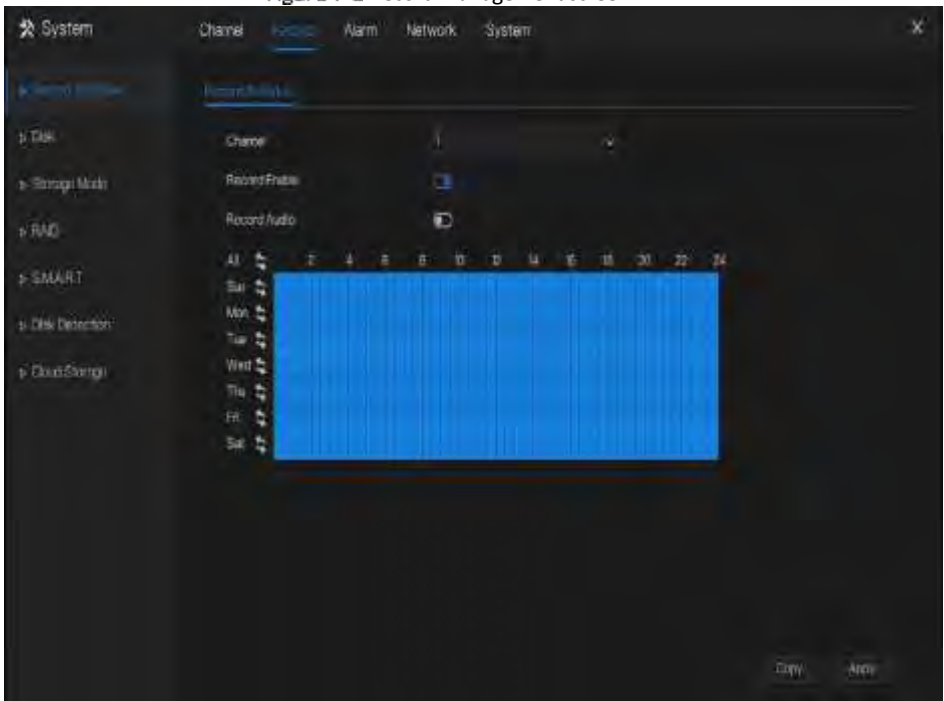

Operation Steps

Step 1 Select a channel from the drop-down list of channel.

Step 2 Enable the record enable.

Step 3 Enable the record audio.



Step 4 Set the record schedule. **Method 1:** Hold down the left mouse button, drag and release mouse to select the arming time within 00:00-24:00 from Monday to Sunday.

 **NOTE**

- When you select time by dragging the cursor, the cursor cannot move out of the time area. Otherwise, no time would be selected.
- The selected area is blue. The default is all week.

Method 2: Click  in the record schedule page to select the whole day or whole week.

Step 5 Deleting record schedule: Click  again or inverse selection to delete the selected record schedule.

Step 6 Click  and select channels or tick **all**, then click  to apply the record management settings to cameras in selected channels , click  to save settings.

----End

7.4.2 Disk

View the total capacity of disk, disk status, disk SN code and storage space of disk. You can format the disk and set record expiration manner.

Operation Description

Step 1 Click **Record** in the main menu or menu of the record screen and choose **Disk** to access the disk screen, as shown in Figure 7-9.

Figure 7-9 Disk screen



Step 2 Click **Format**. The message “Are you sure to format disk? Your data will be lost” is displaying.

Step 3 Choose the disk group, there are four groups.

Step 4 Click **OK**, and the disk would be formatted.

Step 5 Record expiration setting. Select record expiration days from the drop-down list of record expiration.

Step 6 Click **Apply** to save the settings.

NOTE

The disk groups can keep the recording of channels at different disks, it will improve the storage efficiency.

----End

7.4.3 RAID

 **NOTE**

RAID is only used for the device with 4 disks or more. And the disks must be enterprise level disks. The capacity of disks are better same for efficient using.

RAID5 at least 3 disks can be created. RAID6 at least 4 disks can be created. RAID10 at least 4 disks can be created. Create hot spare disk need more one disk or double basic disks.

The capacity of disks are better same for efficient using.

Figure 7-10 RAID

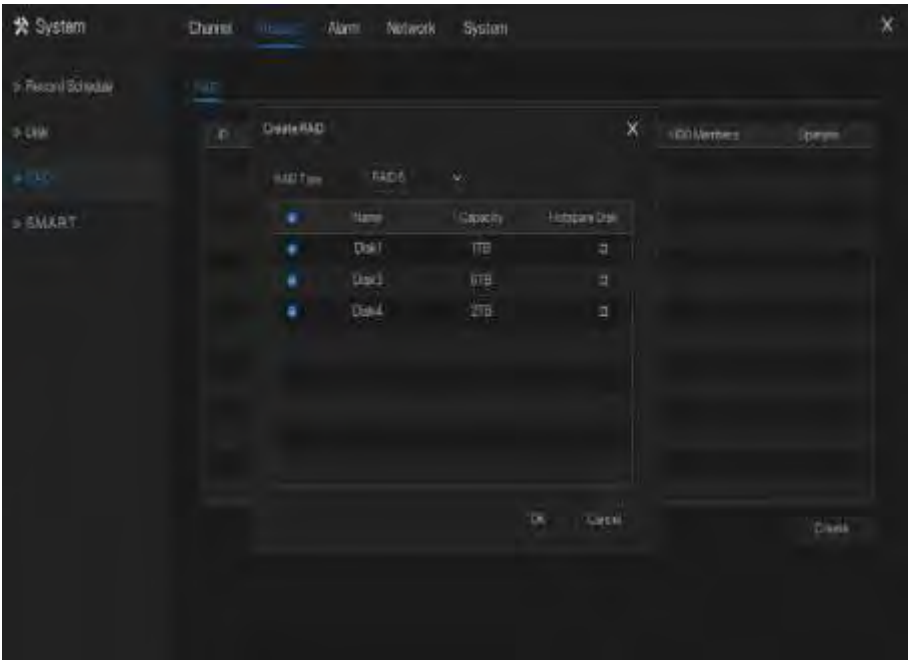

Operation Steps

Step 1 Click **RAID** to create the RAID.

Step 2 Click **Create** to choose disk to create a new RAID.

Step 3 Tick the **Hot-spare Disk** to back up the broken disk in case, the number of disk must more than basic disks.

Step 4 Click **OK** to save the creation, format the new RAID.

7.4.4 Storage Mode

User is based on need to distribute the channels to different disk group, and use disk capacity reasonably, as shown in Figure 7-11

Figure 7-11 Storage mode

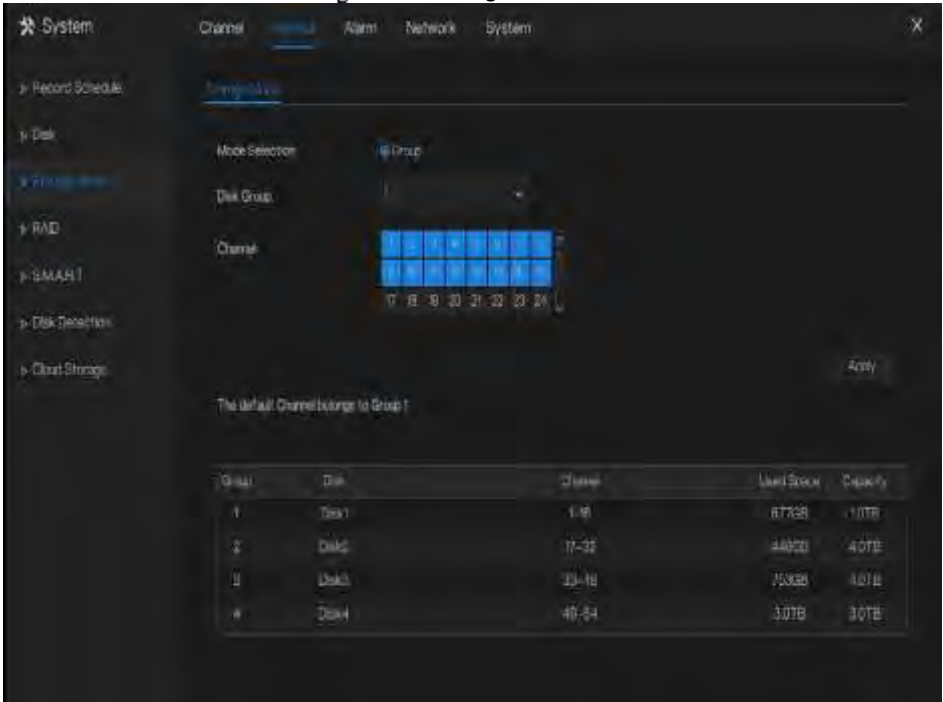

Operation Steps

- Step 1 Choose the disk group.
- Step 2 Select the channel to record to disk group.
- Step 3 Click **Apply** to save the settings.
- Step 4 The group list will show the detail information.

NOTE

If the channels are not in list, it means NVR will not to record these channels, please make sure about all channels are in list.

Choose number of channel number you should consider the capacity of disk group.

7.4.5 S.M.A.R.T

S.M.A.R.T is Self-Monitoring Analysis and Reporting Technology, user can view the health of disk, as shown in Figure 7-12.

Figure 7-12 S.M.A.R.T

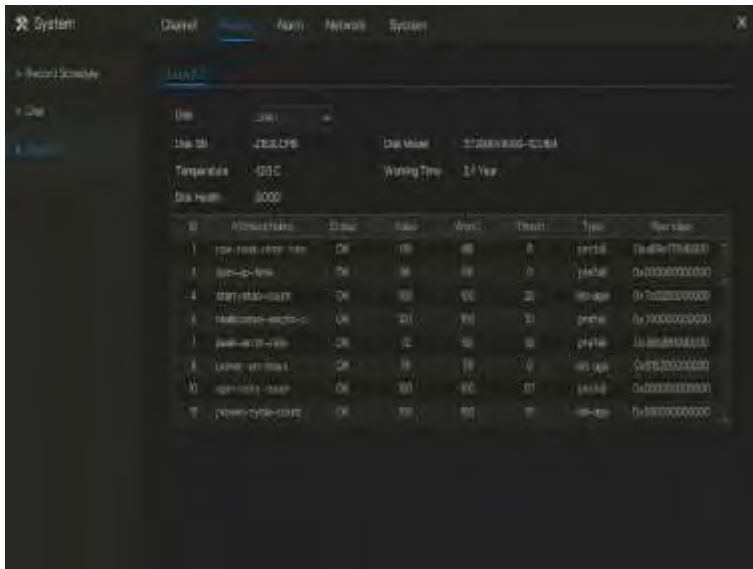

ID	Attributes	Status	Value	Preval	Health	Type	Remarks
1	raw-read-error-rate	OK	100	98	B	critical	10000000000000
2	spin-up-time	OK	96	98	0	critical	00000000000000
4	start-stop-count	OK	100	90	20	usage	00000000000000
6	reallocated-sector-count	OK	201	100	10	critical	00000000000000
7	seek-time-avg	OK	10	90	10	critical	00000000000000
8	spin-time-out	OK	10	10	0	usage	00000000000000
10	spin-reread-count	OK	100	90	10	critical	00000000000000
19	power-cycle-count	OK	100	90	10	usage	00000000000000

7.4.6 Disk Detection

Before the recording the video, user need to detect the disk to keep the data safety, as shown in Figure 7-13.

Figure 7-13 Disk Detection

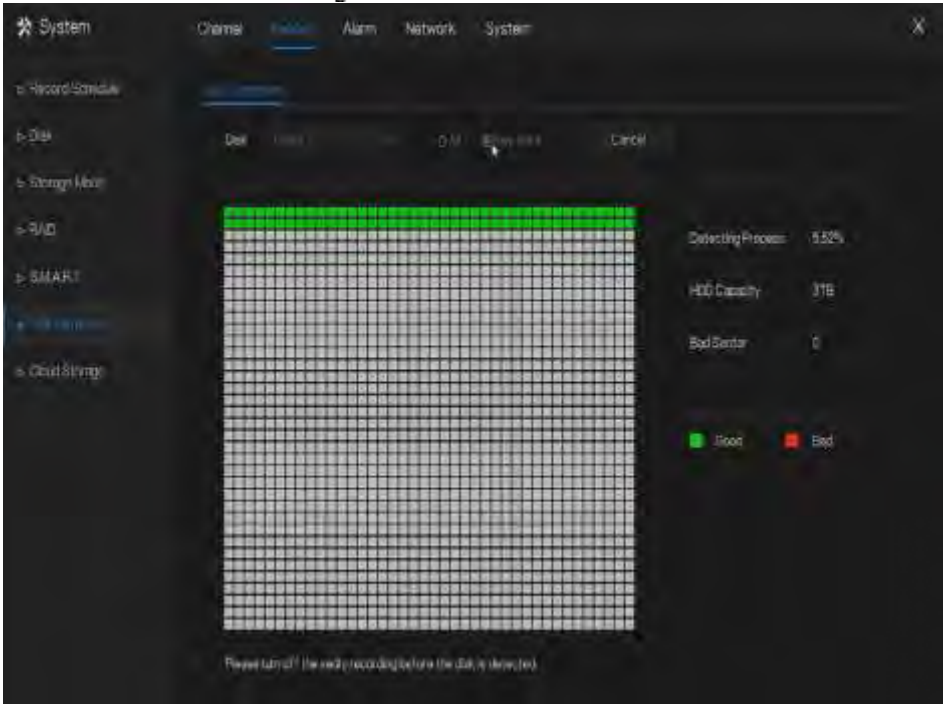

Operation Steps

Step 1 Choose the disk from the drop-down list.

Step 2 Tick all or key to detect the disk. Detect all need some time, detect key section maybe need a few minutes.

Step 3 Click Scan to scan the disk.

Step 4 The result of disk will show in interface

NOTE

The green block means good, the red block means bad, if the red blocks are too much or at key section, please change the disk immediately

Please turn off the video recording before the disk is detected, otherwise the recording of video maybe lost.

7.4.7 Cloud Storage

The cloud storage can save the motion detection and intelligent analysis alarm, if user certificate the Google Drive.

Figure 7-14 Cloud Storage

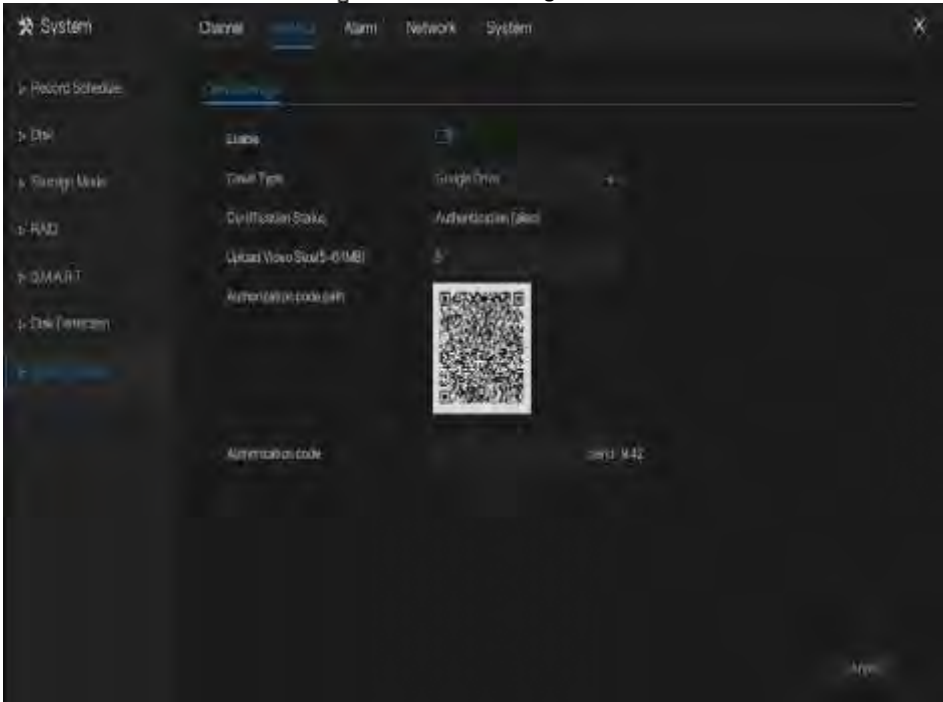

Operation Steps

Step 1 Enable the cloud storage, and the UUID of code path will show.

Step 2 Choose the cloud type, the default is Google cloud.

Step 3 Set upload video size, the video is saving in sub stream(the video size is less).

Step 4 Use browser to scan the UUID to jump to Google drive certification, input the account and password to certificate the NVR.

Step 5 Input the code , click Send to fish certificate, as shown in Figure 7-15.

Figure 7-15 Certification

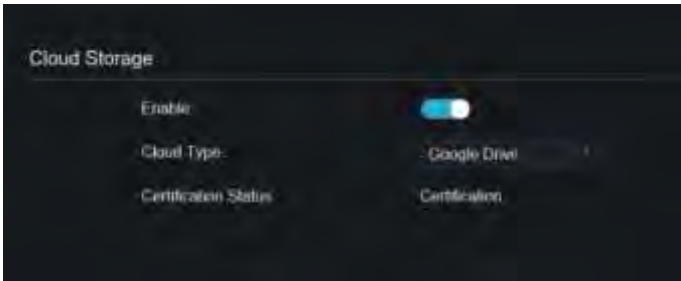

Step 6 Click Apply to save the settings

 **NOTE**

Google Cloud only needs to be authenticated once, without multiple authentications. After the authentication is completed, the cloud storage function can be turned on or off as required.

This function needs to be re-certified after the device is restored to factory settings.

The UUID is the path of Google drive.

7.5 Alarm Management

Set the **General alarm information, Motion Detection, Video Loss, Intelligent Analysis, Alarm In** and **Abnormal Alarm** in alarm management screen.

7.5.1 General

Step 1 Click **Alarm** in the main menu (or click the alarm page of any function screen in the main menu) to access the alarm management screen, as shown in Figure 7-16.

Figure 7-16 Alarm management screen

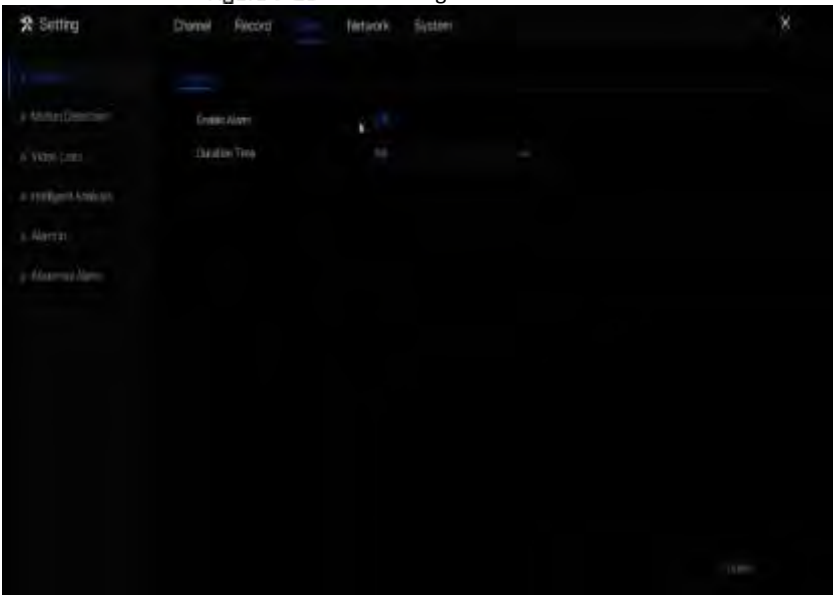

Step 2 Enable the Enable alarm button.

Step 3 Select a value from the drop-down list of duration time.

Step 4 Click **Apply** to save alarm settings.

----End

7.5.2 Motion Detection

The NVR will send motion detection alarm while something moving in the specific view of camera.

Operation Description

Step 1 Click **Motion Detection** in the main menu or menu of the alarm management screen and choose **Motion Detection** to access the Motion Detection screen, as shown in Figure 7-17.

Figure 7-17 Motion detection screen

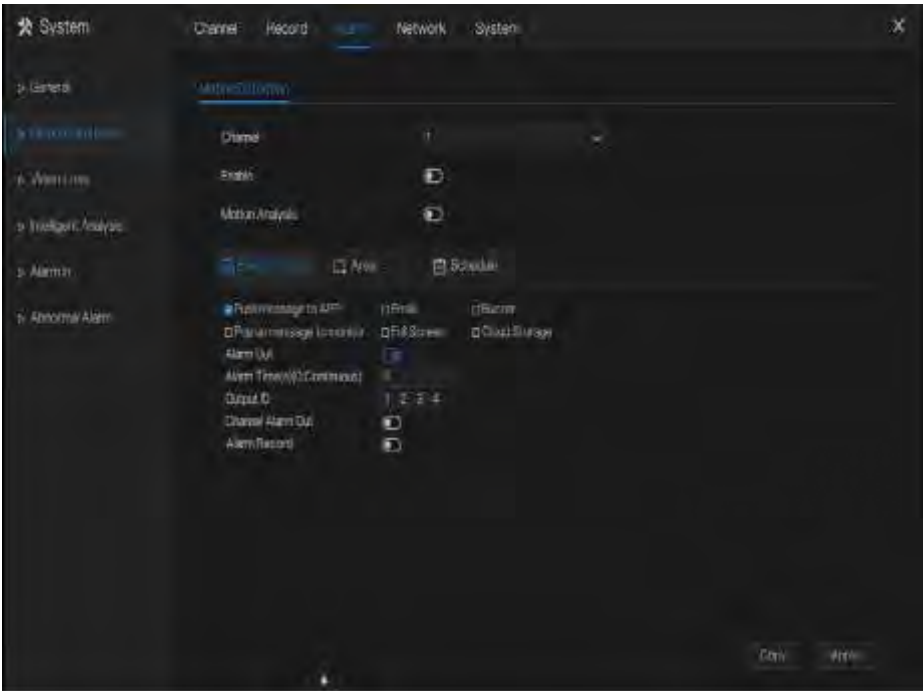

Operation Steps

Step 1 Select a channel from the drop-down list of channel.

Step 2 Click  to enable motion detection.

Step 3 Enable motion analysis, if the camera detect the motion action, the area will be block as shown in Figure 7-18.

Step 4 Enable the Event actions include: push to APP, Email, Buzzer, Pop up message to monitor, Full screen, Cloud storage, Alarm out, Channel alarm out, and alarm record.

Step 5 Click Area page to access the motion detection area setting, as shown in Figure 7-18.

Figure 7-18 Motion detection area setting screen

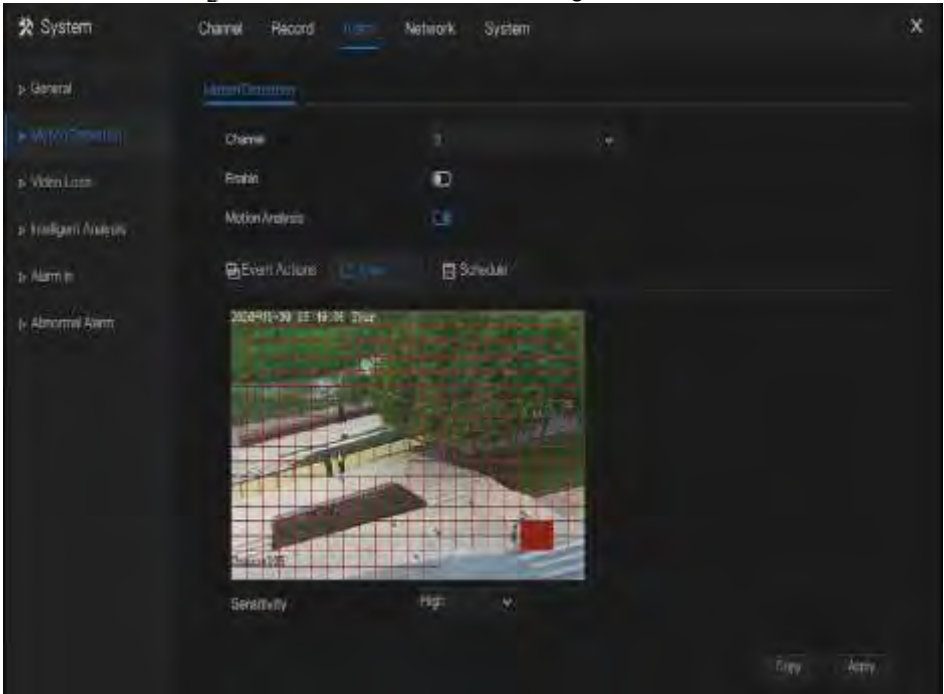

Area :

1. Hold down and drag the left mouse button to draw a motion detection area.
2. Select a value from the drop-down list next to **Sensitivity**.

Step 6 Click **Schedule** page to access the schedule screen. For details, please see 7.4.1 Record Schedule Figure 7-8Step 4 Set the record schedule.

Step 7 Click **Copy** and select channels or tick **all**, then click **OK** to apply the motion detection settings to cameras in selected channels, click **Apply** to save motion detection alarm settings.

NOTE

After a motion detection area is selected, double-click it to delete the selected area.

The default area is whole area.

If you leave the page without applying, the tip “Do you want to save?” would show. Click save to save the settings. Click cancel to quit the settings.

Enable the alarm out, user need to set alarm time and output ID, four ID are correspond to back panel’s alarm out, 1 A and 1 B, 2 A and 2 B, 3 A and 3 B, 4 A and 4 B.

Channel alarm out is correspond to alarm port of camera.

----End

7.5.3 Video Loss

If a camera is disconnected to NVR, it will trigger video loss alarm.

Operation Description

Click **Video Loss** in the main menu or menu of the alarm management screen and choose **video Loss** to access the video loss screen, as shown in Figure 7-19.

Figure 7-19 Video loss screen

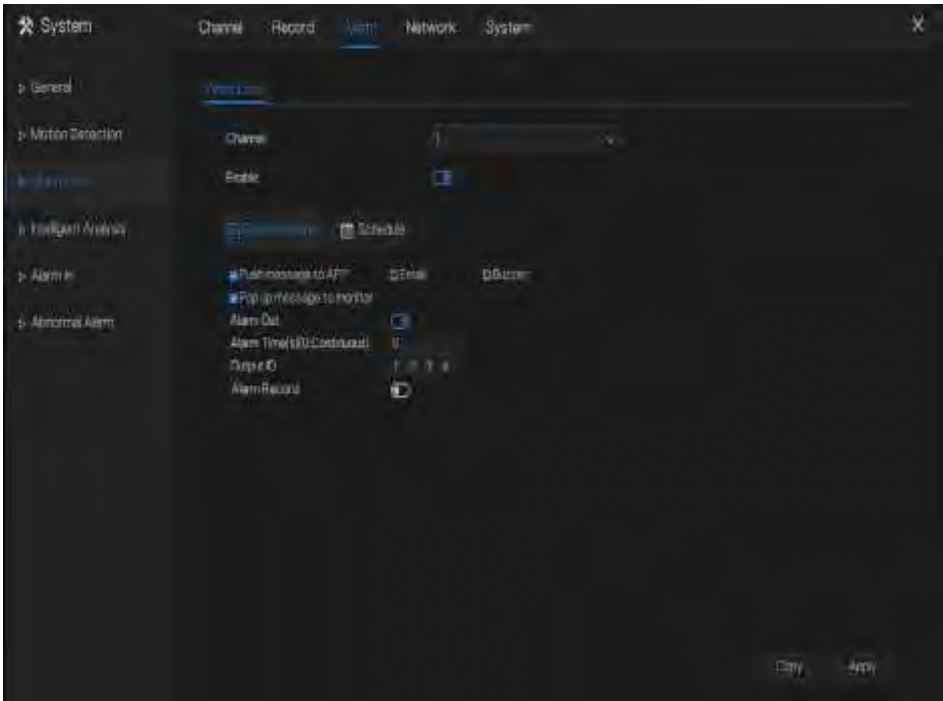

Operation Steps



Step 1 Select a channel from the drop-down list of channel.

Step 2 Click  to enable video loss alarm.

Step 3 Enable the Event actions include: buzzer, alarm out, push message, pop up message, send E-mail and post recording.

Step 4 Click Schedule page to access the schedule screen.

Step 5 For details, please see 7.4.1 Record Schedule Figure 7-8Step 4 Set the record schedule.

Step 6 Click  and select a channel, then click  to apply the parameter settings to cameras in selected channels, click  to save video loss settings.

----End

7.5.4 Intelligent Analysis

Operation Description

Step 1 Click **Intelligent Analysis** in the main menu or menu of the alarm management screen and choose **Intelligent Analysis** to access intelligent analysis screen, as shown in Figure 7-6.

Figure 7-20 Intelligent Analysis screen

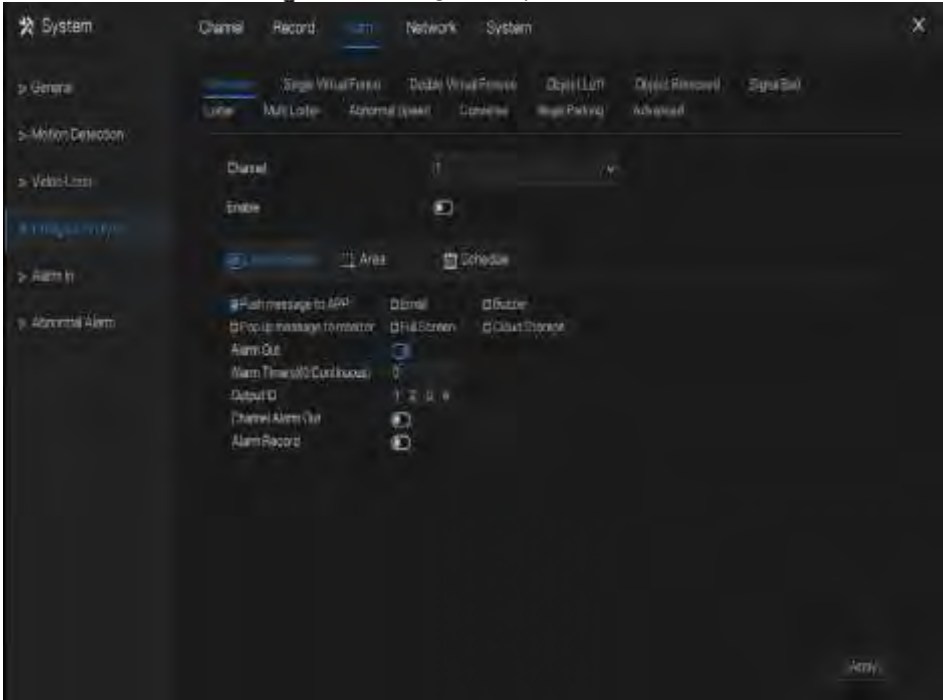

Step 2 Select one action to set the alarm.(perimeter, single virtual fence, double virtual fences, object left, signal bad, loiter, multi loiter, abnormal speed, converse, illegal parking, advanced)

Step 3 Select a channel from the drop-down list of channel.

Step 4 Click  to enable intelligent analysis alarm.

Step 5 Enable the event actions include: buzzer, alarm out, push message, pop up message, send E-mail and post recording.

Step 6 Click Schedule page to access the schedule screen.

Step 7 For details, please see Figure 7-8Step 4 Set the record schedule.

Step 8 Click **Copy** and select a channel, then click **OK** to apply the parameter settings to cameras in selected channels, click **Apply** to save video loss settings.

----End

7.5.5 Alarm In

There two types alarm in, one is the NVR's alarm in, another is the camera channel's alarm in.

Operation Description

Click **Alarm in** in the main menu or menu of the alarm management screen and choose **Alarm in** to access the alarm in screen, as shown in Figure 7-21.

Figure 7-21 Alarm in screen

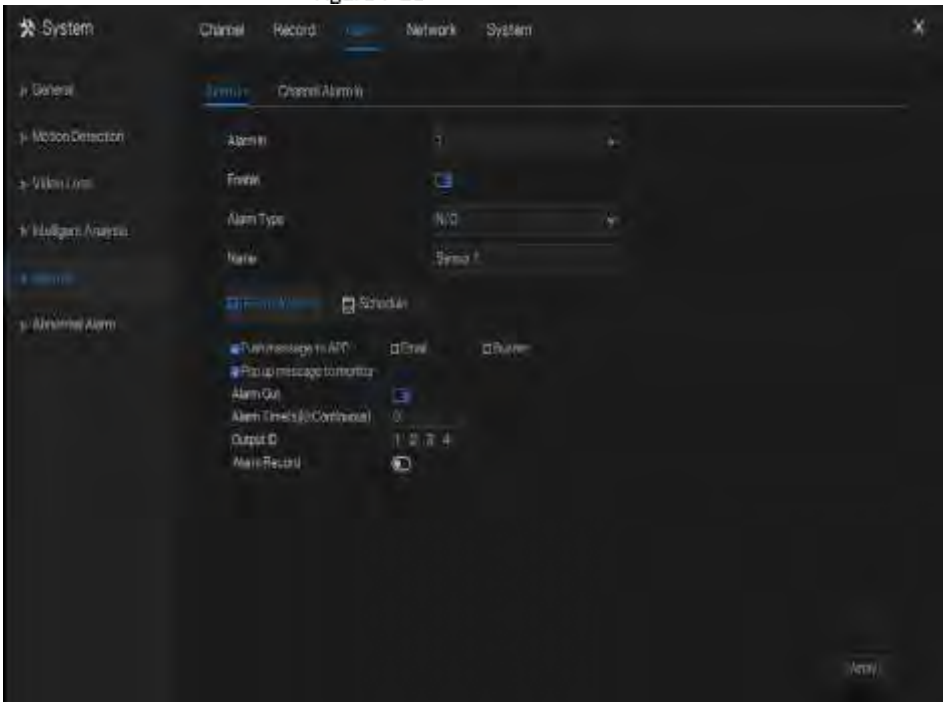
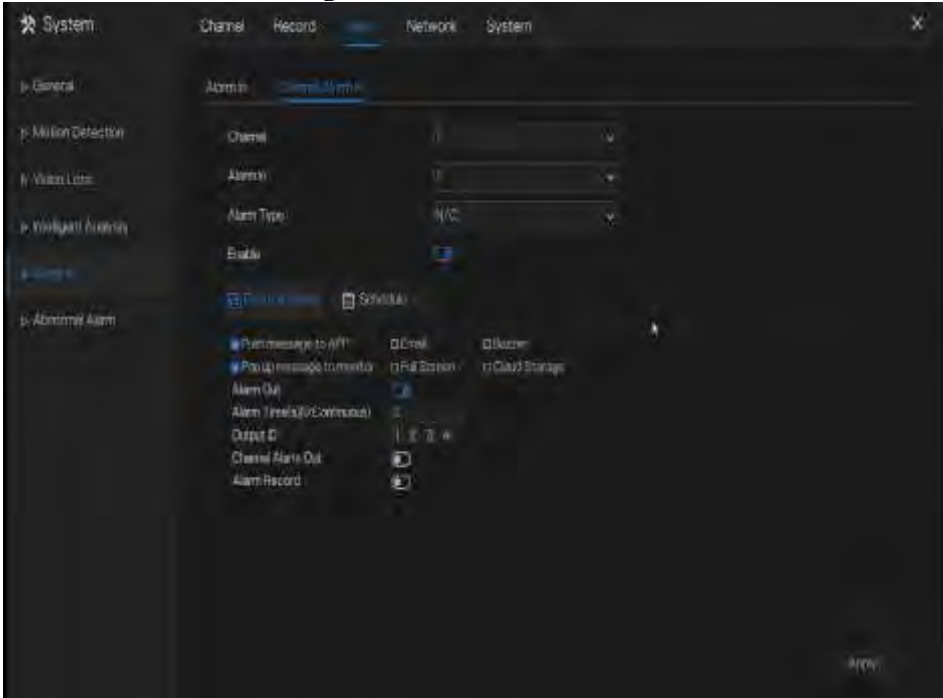



Figure 7-22 Channel alarm in



Operation Steps

Step 1 Select a channel in **alarm in**.

Step 2 Click  to enable or disable the functions.

Step 3 Select **Alarm type** from the drop-down list.

NOTE

NC: Normal close the alarm

NO: Normal open the alarm

Step 4 Set **name**.

Step 5 Enable the event actions include: buzzer, alarm out, push message, pop up message, send E-mail and post recording.

Step 6 Click **Schedule** page to access the schedule screen. For details, please see 7.4.1 Record Schedule Figure 7-8Step 4 Set the record schedule.

Step 7 Click  to save alarm in settings.

----End

7.5.6 Abnormal Alarm

Abnormal alarm includes disk alarm, IP conflict and network disconnected.

Operation Description

Step 1 Click **Abnormal Alarm** in the main menu or menu of the alarm management screen and choose **Abnormal Alarm** to access the abnormal alarm screen, as shown in Figure 7-23.

Figure 7-23 Abnormal alarm screen

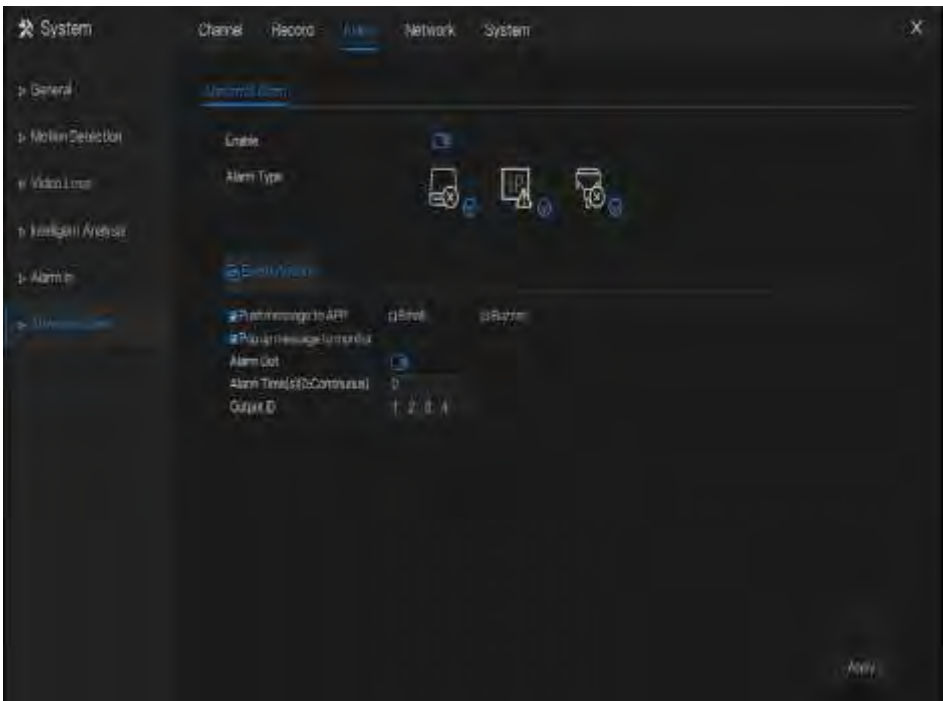

Operation Steps

Step 2 Tick the abnormal actions.

Step 3 Enable the event actions include: buzzer, alarm out, push message, pop up message, send E-mail and post recording.

Step 4 Click **Apply** to save abnormal alarm settings.

----End

7.6 Network Management

Set the **Network Parameter, 802.1X, DDNS, E-mail, Port Mapping, P2P, IP Filter, SNMP 3G/4G** and **PPPOE** in the network management screen.

Operation Description

Step 1 Click **Network** in the main menu (or click the network page of any function screen in the main menu) to access the network management screen, as shown in Figure 7-24.

Figure 7-24 Network management screen

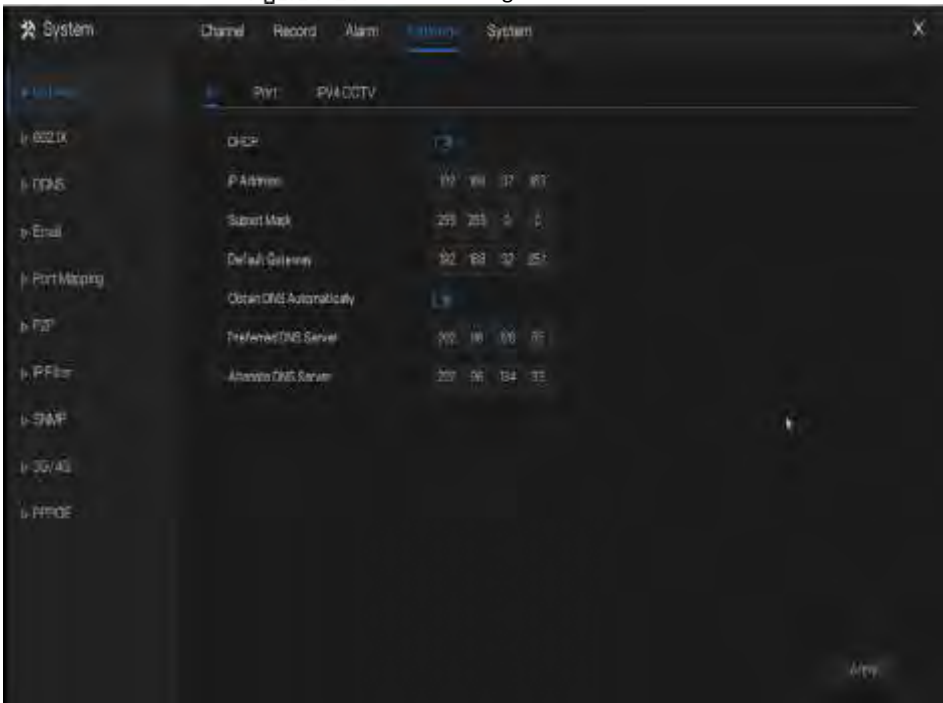



7.6.1 Network

Set **DHCP** and **DNS** manually or automatically.

7.6.1.1 IP

Operation Steps

- Step 1 Click  next to **DHCP** to enable or disable the function of automatically getting an IP address. The function is disabled by default.
- Step 2 If the function is disabled, click input boxes next to **IP**, **Subnet mask**, and **Gateway** to set the parameters as required.
- Step 3 Click  next to **Obtain DNS Automatically** to enable or disable the function of automatically getting a DNS address. The function is enabled by default.
- Step 4 If the function is disabled, click input boxes next to **DNS 1(default 192.168.0.1)** and **DNS 2(default 8.8.8.8)**, delete original address, and enter new address.
- Step 5 Click  to save IP settings.
- End

7.6.1.2 Port

Operation Steps

- Step 1 Click **Port** page to access the port setting screen, as shown in Figure 7-25.

Figure 7-25 Port setting screen

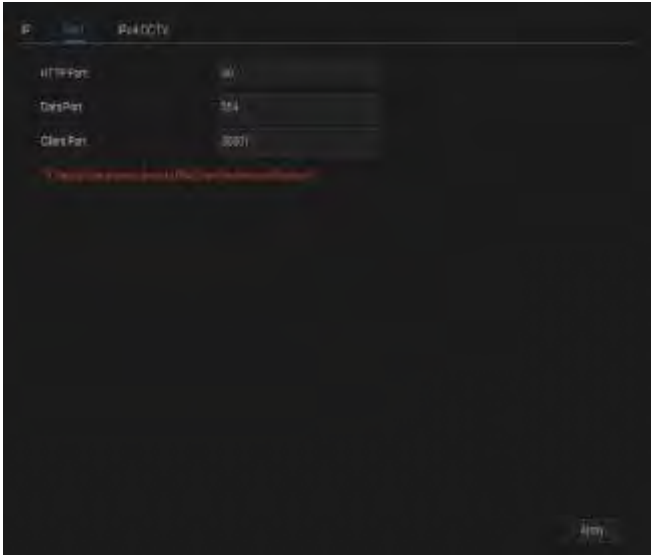

Step 2 Set the web port, data port and client port.

Step 3 Click **Apply** to save port settings.

----End

7.6.1.3 IPv4CCTV

The no POE device have two LANs, LAN1 and LAN2.

Operation Steps

Step 1 Click **IPv4 CCTV** page to access the LAN2 setting screen, as shown in Figure 7-26.

Figure 7-26 IPv4 CCTV

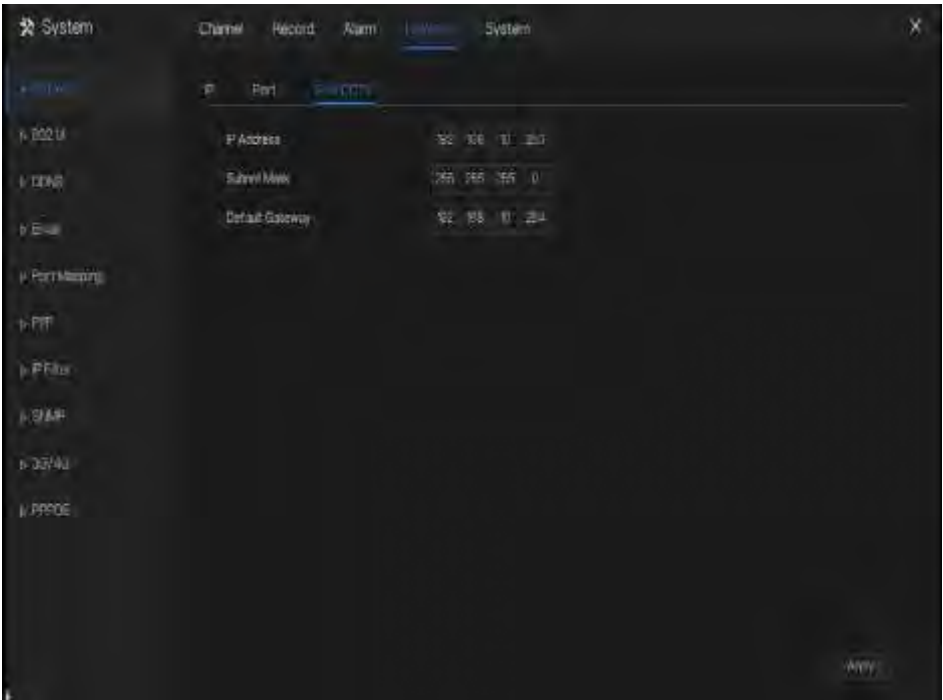

Step 2 Input the IP address, subnet mask, default gateway.

Step 3 Click **Apply** to save the settings.

NOTE

LAN1 and LAN2 can connect to different network, so that NVR can add more cameras. LAN1 usually connect to the external network, it is default gateway. LAN2 connect to internal network.

7.6.1.4 POE

Operation Steps

Step 1 Click **POE** page to access the POE setting screen, as shown in Figure 7-27.

Figure 7-27 POE screen

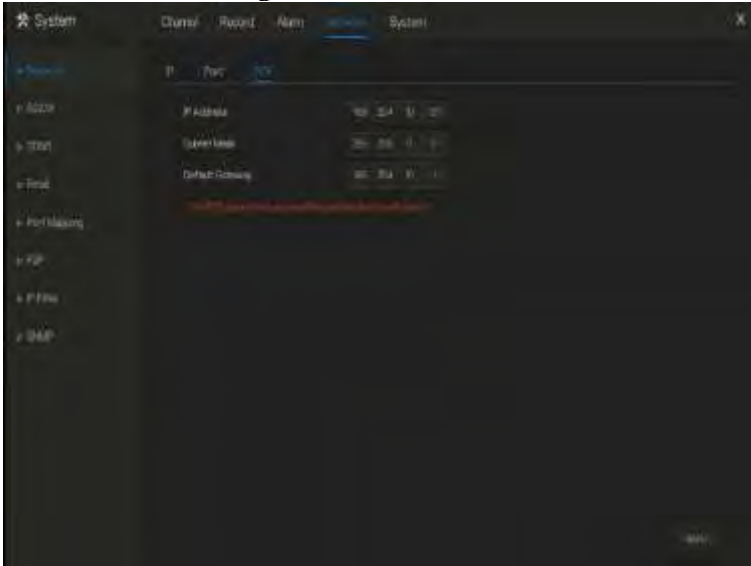

Step 2 The NVR will deploy IP addresses to the cameras which connect POE immediately.

Step 3 Click **Apply** to set POE camera IP address successfully.

----End

7.6.1.5 WiFi Parameter

Operation Steps

Step 1 Click **WiFi Parameter** page to access the WiFi Parameter setting screen, as shown in Figure 7-27.

Figure 7-28 WiFi Parameter

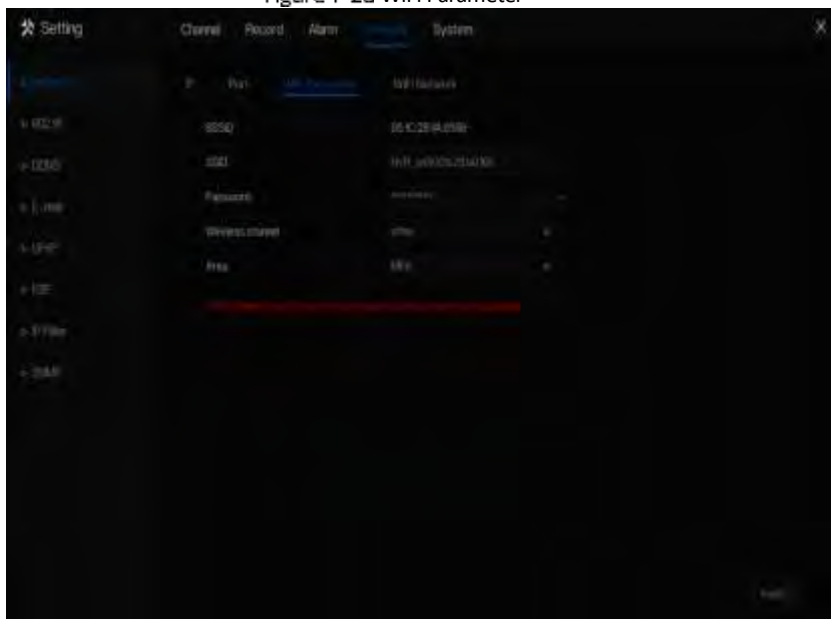

Step 2 Set the parameters of WiFi.

Step 3 Click **Apply** to set POE camera IP address successfully.

NOTE

BSDID, default value of the device, cannot be changed.

SSID, the name can be changed to facilitate customer search.

WiFi channel; 1-13 channels, plus the other channel, can be changed according to network blocking conditions to avoid interference.

The area can be selected according to the country where it is located, MKK, ETSI1, ETSI2, FCC.

7.6.1.6 WiFi Network

Operation Steps

Step 1 Click **WiFi Parameter** page to access the WiFi Parameter setting screen, as shown in Figure 7-27.

Figure 1-1 WiFi network

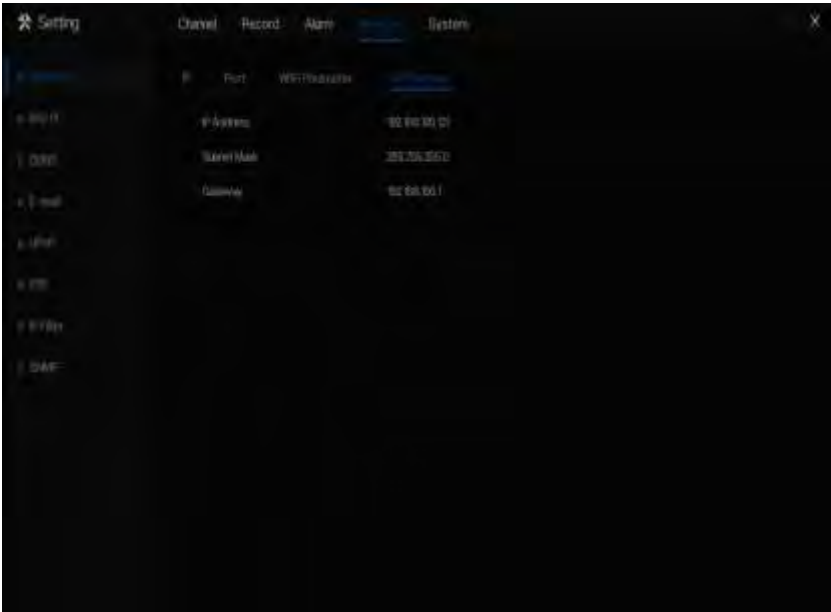

----End

7.6.2 802.1 X

Operation Steps

Step 1 Click  next to **802.1 X** to enable or disable the function .The default is disabled.

Figure 7-29 802.1X



Step 2 Input the user and password of 802.1X, the account is created by user.

Step 3 Click **Apply** to save the settings. The visitor to view the NVR need to input account to certify.

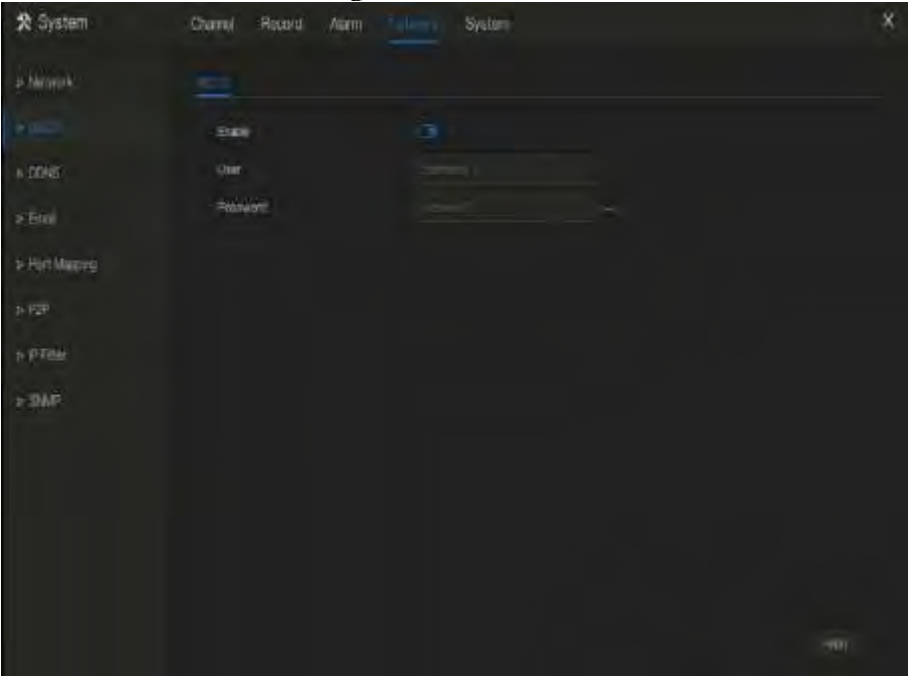
7.6.3 DDNS

Please make sure of connecting the specified camera to the Internet, and obtain the user name and password for logging into the dynamic domain name system (DDNS) from the server.

Operation Steps

Step 1 Click **DDNS** in the main menu or menu of the network management screen and choose **DDNS** to access the DDNS screen.

Step 2 Click next to **Enable** to enable the DDNS function. It is disabled by default, as shown in Figure 7-30.

Figure 7-30 DDNS setting screen

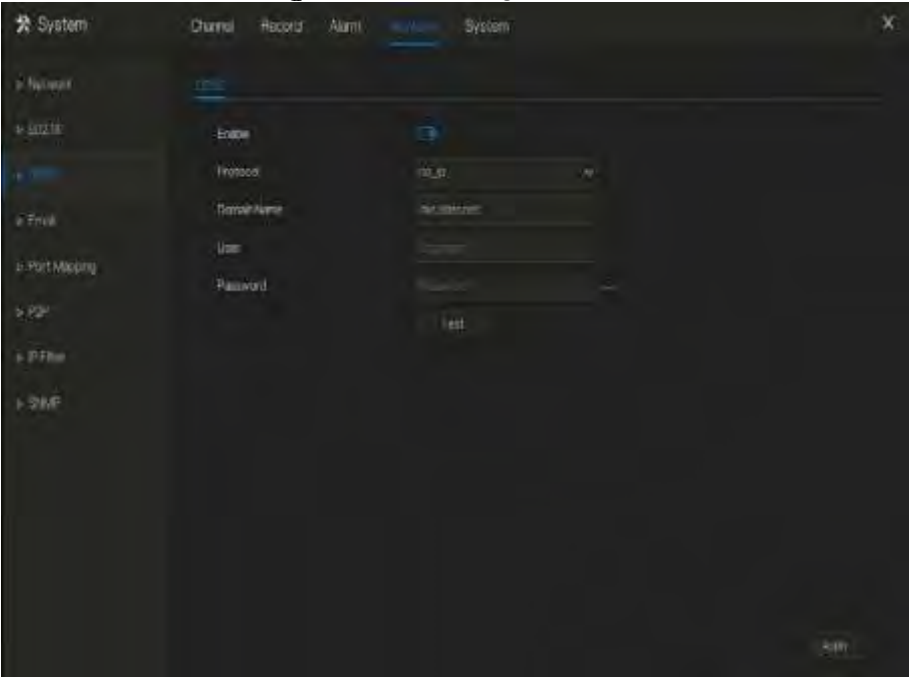

Step 3 Select a required value from the protocol drop-down list.

Step 4 Set domain name, input user and password.

Step 5 Click **Test** to check the domain name.

Step 6 Click **Apply** to save DDNS network settings

NOTE

An external network can access the NVR via an address that is set in the DDNS settings.

----End

7.6.4 E-mail

If the simple mail transfer protocol (SMTP) function is enabling, the device automatically sends alarm information to specified email addresses when an alarm is generated.

Operation Steps

Step 1 Click **E-mail** in the main menu or menu of the network management screen and choose **E-mail** to access the E-mail screen, as shown in Figure 7-31.

Figure 7-31 E-mail setting screen

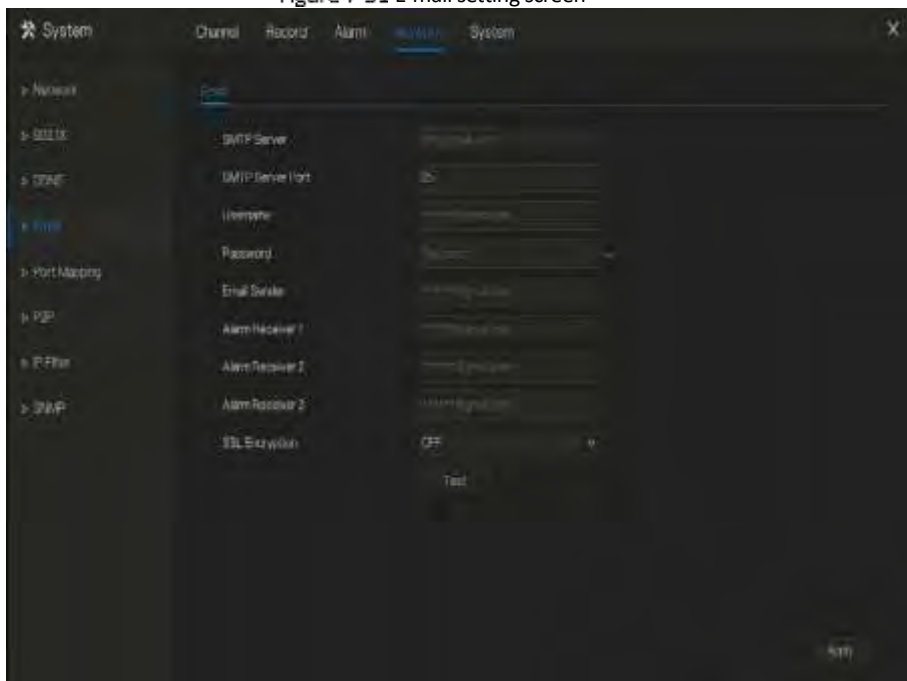

Step 2 Set SMTP server and SMTP server port manually.

Step 3 Input E-mail sender, user name and password manually.

Step 4 Set E-mail for receive alarm. the message “**Mail has been sent, please check**” is displaying. Open the mail, if the verification code is received, that shows the E-mail is set successfully.

Step 5 Set E-mail for retrieve the password. the message “Mail has been sent, please check” is displaying. Open the mail, if the verification code is received, that shows the E-mail is set successfully.

Step 6 Set SSL encryption for encrypting mail or not.

Step 7 Click **Apply** to save settings.

----End

7.6.5 Port Mapping

Operation Steps

Step 1 Click **Port Mapping** in the main menu or menu of the network management screen and choose **Port Mapping** to access the port mapping screen, as shown in Figure 7-32.

Figure 7-32 Port mapping setting screen



Step 2 Select UPnP enable type.

Step 3 Manual UPnP: input http port, data port and client port manually.

Step 4 Auto UPnP: device obtain the port automatically.

Step 5 Click **Apply** to save settings.

----End

7.6.6 P2P

Show the UUID code and set the P2P status of the device.

Operation Steps

Step 1 Click **P2P** in the main menu or menu of the network management screen and choose **P2P** to access the P2P screen, as shown in Figure 7-33.

Figure 7-33 P2P screen



Step 2 Click to enable the P2P function.

Step 3 Click **Apply** to save P2P network settings or click **Cancel** to cancel settings.

Step 4 After the **Inview Pro4** is installed in mobile phone, run the APP and scan the QR to add and access the NVR when the device is online.

----End

7.6.7 IP Filter

Set the IP address in specified network segment to allow or prohibit access.

Operation Steps

Step 1 Click **IP Filter** in the main menu or menu of the network management screen and choose **IP Filter** to access the IP filter screen, as shown in Figure 7-34.

Figure 7-34 IP Filter setting screen

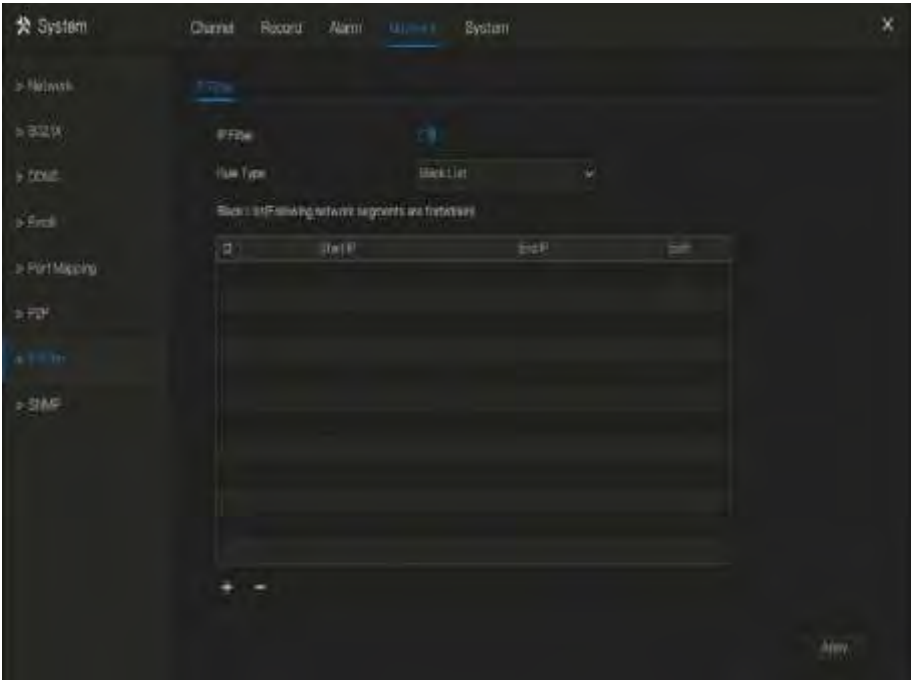

Step 2 Click  next to **IP Filter** to enable the function of IP Filter.

Step 3 Select black list or white list drop-down list.

Step 4 Click  to set black & white list IP segment screen is displaying, as show in Figure 7-

35.

Figure 7-35 IP Address Segment screen

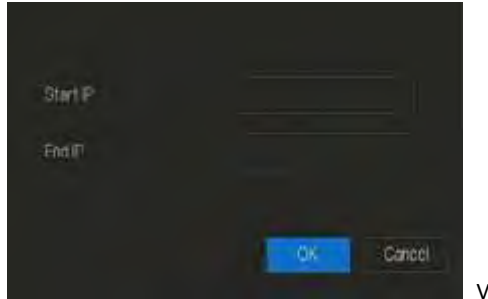

Step 5 Enter value manually for start IP address, end IP address.

Step 6 Click **OK**. The system saves the settings. The black and white lists IP segment listed in the black (white) list.

NOTE

Black list: IP address in specified network segment to prohibit access.

White list: IP address in specified network segment to allow access

Select a name in the list and click **Delete** to delete the name from the list.

Select a name in the list and click **Edit** to edit the name in the list.

Only one rule type is available, and the last rule type set is efficient.

----End

7.6.8 SNMP

There are three versions of simple network management protocol at interface.

Operation Steps

Step 1 Click **IP Filter** in the main menu or menu of the network management screen and choose **IP Filter** to access the IP filter screen, as shown in Figure 7-36.

Figure 7-36 SNMP settings screen

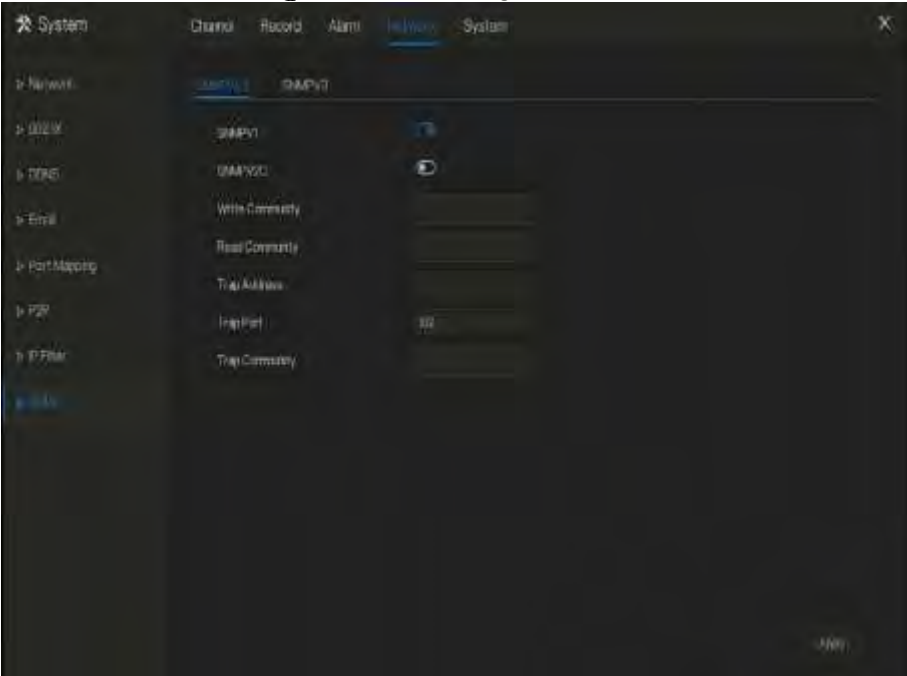



Step 2 Click  next to **SNMPV 1** to enable the function . The interface is shown as Figure 7-37.

Figure 7-37 SNMPV 1/2 interface

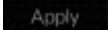

Step 3 Input the parameters of protocol.

Step 4 Click  to save settings or click  to cancel settings.

----End

7.6.9 3G/4G

User can use modem to connect to data network.

Operation Steps

Step 1 Plug the modem to NVR, and enable the 3G/4G function, as shown in Figure 7-38.

Figure 7-38 3G/4G setting screen

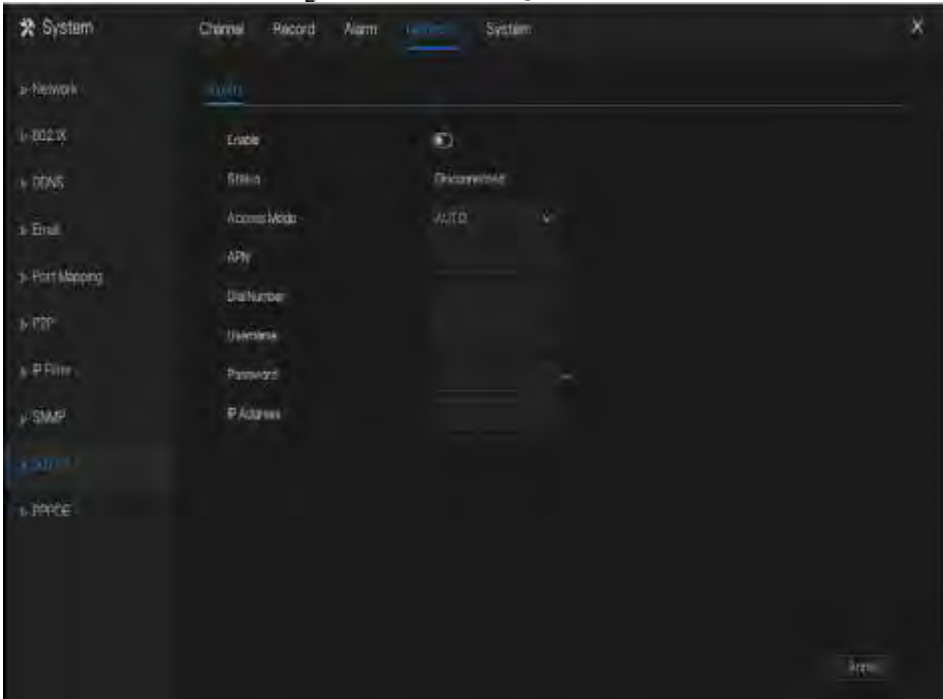

Step 2 The status is connected to set the other parameters.

Step 3 Choose access mode, the default is AUTO. There are five modes can be chosen, such as AUTO, LTE, TD-SCDMA, WCDMA, GSM/GPRS.

Step 4 Input the APN, dial number, username, password, IP address. At auto mode, all these parameters can be obtained automatically.

Step 5 Click **Apply** to save settings.

NOTE

Modify the access mode, if the status is all disconnected in five minutes, please unplug the modem to restart the modem immediately.

Users are familiar with the relevant network (different service provider parameters are different) and modem information before manually switching to other modes, we recommend access mode to choose auto.

When using the 3G / 4G function, you need to manually close the PPPOE function. Only one function can be used at a time.

If the Internet access type is LTE (4G network), you do not need to dial the number, user name and password.

7.6.10 PPPOE

PPPOE point to point protocol Ethernet, user use the PPPOE to access network immediately.

Figure 7-39 PPPOE

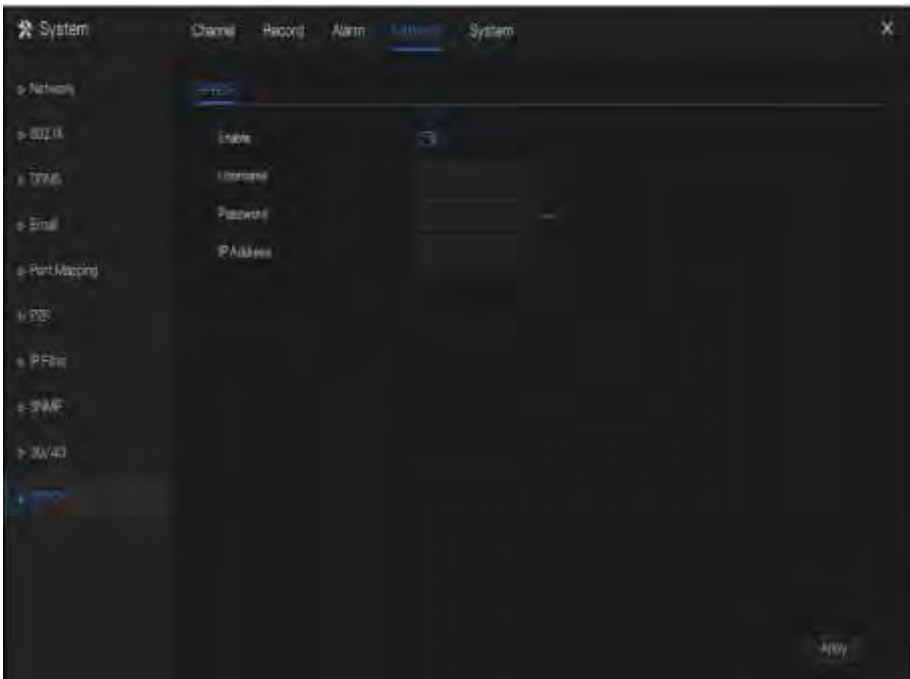

Step 1 Enable the PPPOE function.

Step 2 Input the username, password(Network operator provides).

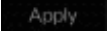
Step 3 Click  to save settings, and the IP is obtained automatically.

Step 4 User input the IP to access NVR web immediately.

----End

7.7 System Management

View the device **Information** and set **General** information, **User**, **Security Center**, **Auto Sequence**, **Logs**, **Maintenance** and **Auto Restart** for the system setting.

Operation Description

Click **System** in the main menu (or click the system page of any function screen in the main menu) to access the system setting screen, as shown in Figure 7-40.

Figure 7-40 System setting screen

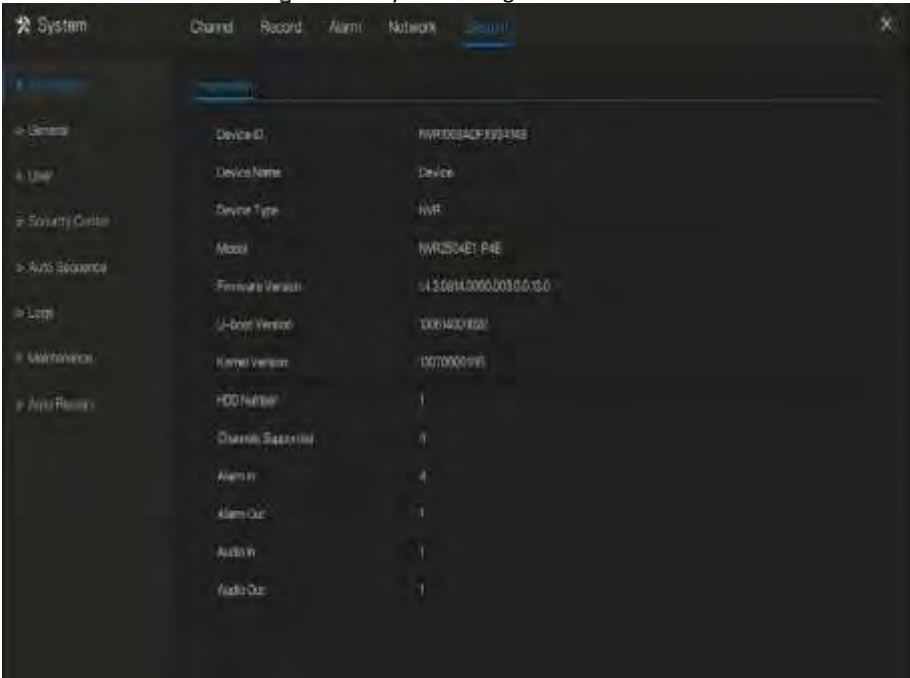

7.7.1 Information

View the device ID, device name, device type, model, firmware version, HDD volume, channel support, alarm in, and alarm out, audio in, audio out in **information** screen, as shown in Figure 7-41 .

Figure 7-41 Information interface

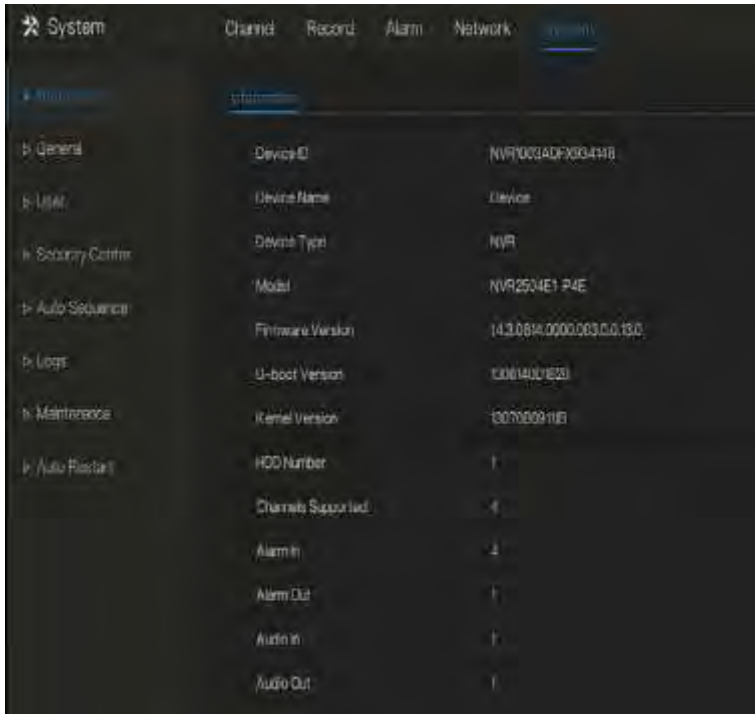

7.7.2 General

7.7.2.1 System

Operation Steps

Step 1 Click **General** in the main menu or menu of the system management screen and choose **General** to access the system screen, as shown in Figure 7-42.

Figure 7-42 system setting screen

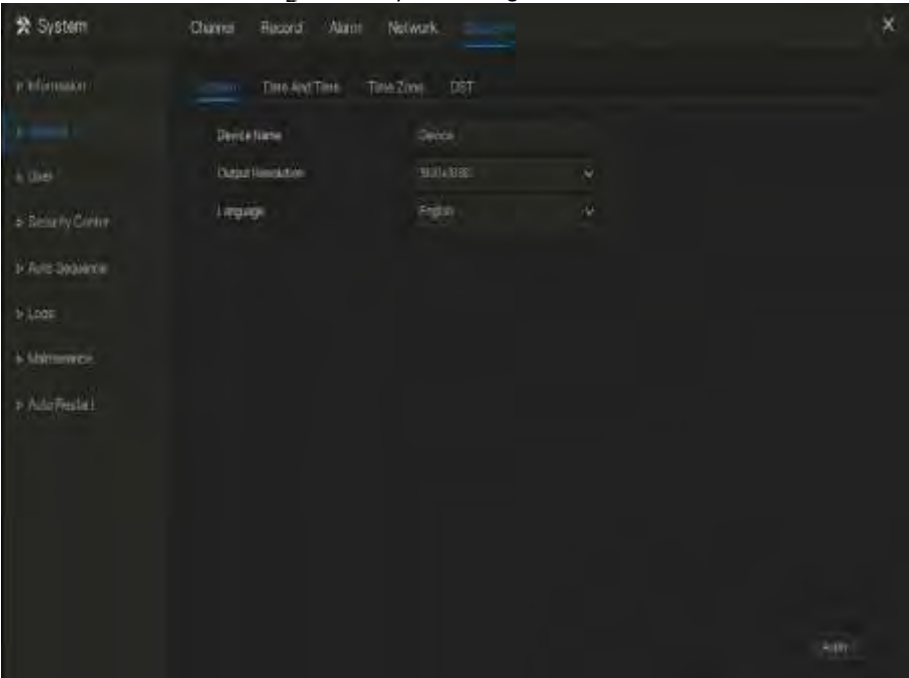

Step 2 Enter device name for selected device.

Step 3 Select a proper resolution from the output resolution drop-down list.

Step 4 Select a required language from the Language drop-down list.

Step 5 Click **Apply** to save settings.

----End

7.7.2.2 Date and Time

Operation Steps

Step 1 Click **Date and Time** page to access the date and time setting screen, as shown in Figure 7-43.

Figure 7-43 Date and Time setting screen

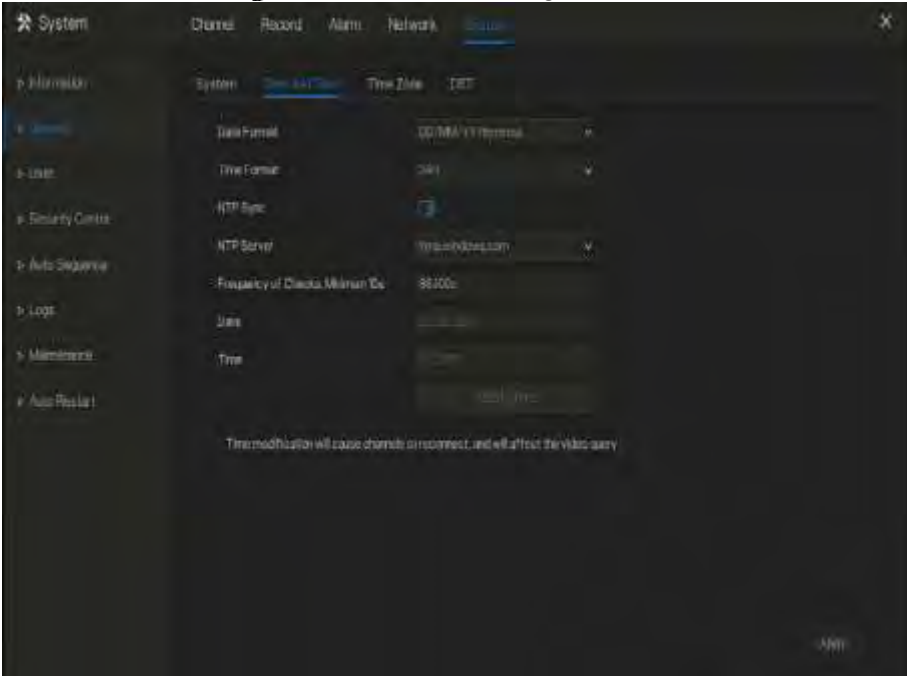

Step 2 Select required format from the Date Format and time format drop-down list.

Step 3 Click next to NTP Sync to disable time synchronization. Time synchronization is enabled by default. Time is synchronized with the NTP.

Step 4 After NTP Sync is disabled, you can manually set the system time:

Click **Date** and scroll the mouse scroll wheel to select the year, month, and date.

Click **Time** and scroll the mouse scroll wheel to select the hour, minute, and second.

Click **Modify Time** to save the time settings.

Step 5 Click Apply to save settings.

----End

7.7.2.3 Time Zone

Operation Steps

Step 1 Click **Time zone** page to access the time zone setting screen, as shown in Figure 7-44.

Figure 7-44 Time zone setting screen

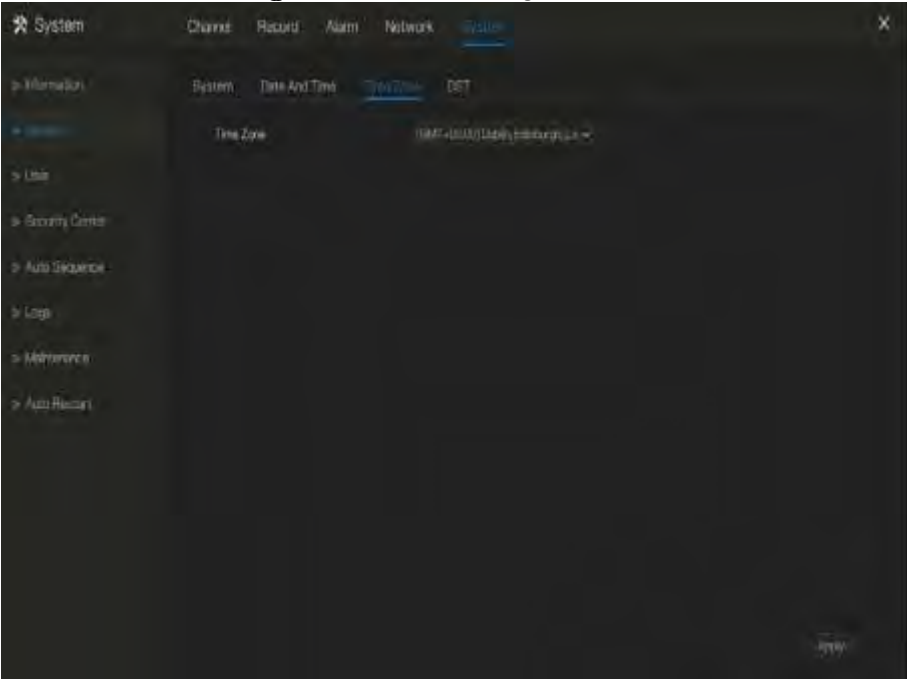

Step 2 Select a required time zone from the Time Zone drop-down list.

Step 3 Click **Apply** to save settings.

----End

7.7.2.4 DST

When the DST start time arrives, the device time automatically goes forward one hour (offset time). When the DST end time arrives, the device time automatically goes backward one hour. The offset time can change if local rule is different.

Operation Steps

Step 1 Click **DST** page to access the DST setting screen, as shown in Figure 7-45.

Figure 7-45 DST setting screen

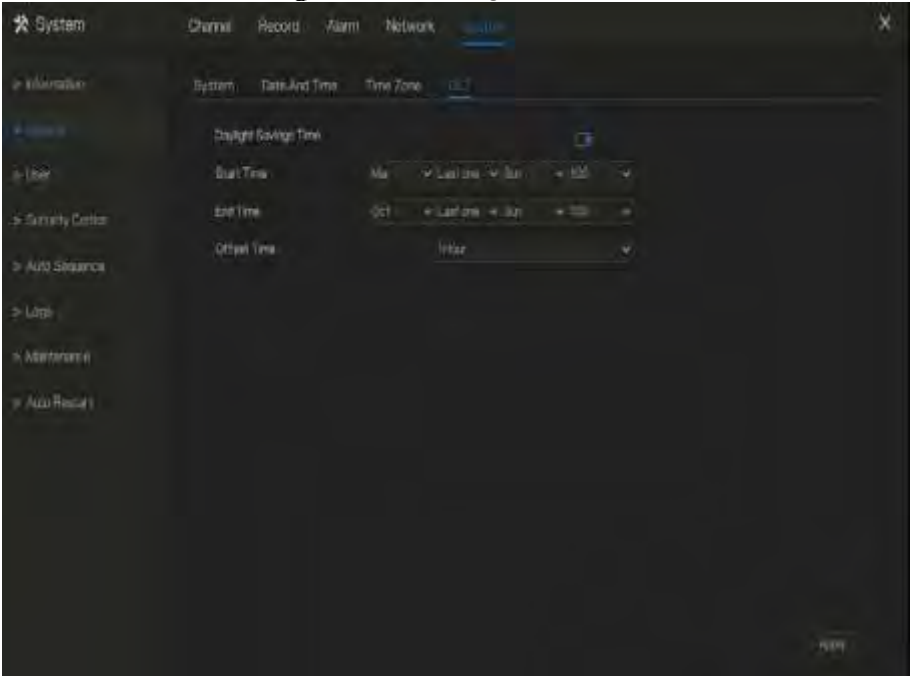

Step 2 Click  next to **DST** to enable DST.

Step 3 Select start time, end time, offset time from the drop-down list respectively, that basis on the local rules.

Step 4 Click  to save settings.

----End

7.7.3 User

Add, modify, and delete a user and privilege in user screen, admin user can dispose privilege to different user.

7.7.3.1 User

Operation Steps

Step 1 Click **User** in the main menu or menu of the system management screen and choose **User** to access the user screen, as shown in Figure 7-46.

Figure 7-46 User management screen



Step 2 Add or delete a user.

- Add a user

Click **Add**, the **Add User** dialog box appears, as shown in Figure 7-47.

Figure 7-47 Add user screen

+ Add User X

Username

Password Password

Confirm Password Password

Group Administrators

Change password reminder Never

Expire date

Live Preview

PIZ

Playback

Channel Management

Device Management

System Management

Thermal

Channel

CH1

CH2

CH3

CH4

CH5

CH6

CH7

CH8

Live Preview

OK Cancel

Input a username, password and confirm password.

 **NOTE**

The password should include letter, character and number, at least two types.

The password should be 6~32 characters.

Step 3 Select a **Group** from the drop-down list box.

Step 4 Select a **Change password reminder** value from the drop-down list box.

Step 5 Enable the expire date to set the new user's authority time.

Step 6 Select the operation privileges and channels in the list of the add user screen.

Step 7 Click . The user is set successfully.

 **NOTE**

The default user is **Administrator** and cannot be deleted or modified.

Select a user from user list and click  to edit , or click  to delete a user.

-----End

7.7.3.2 Advance Setting

Operation Steps

Step 1 Click **User** in the main menu or menu of the system management screen and choose **Adv Setting** to access the user screen, as shown in Figure 7-48.

Figure 7-48 Advance setting screen

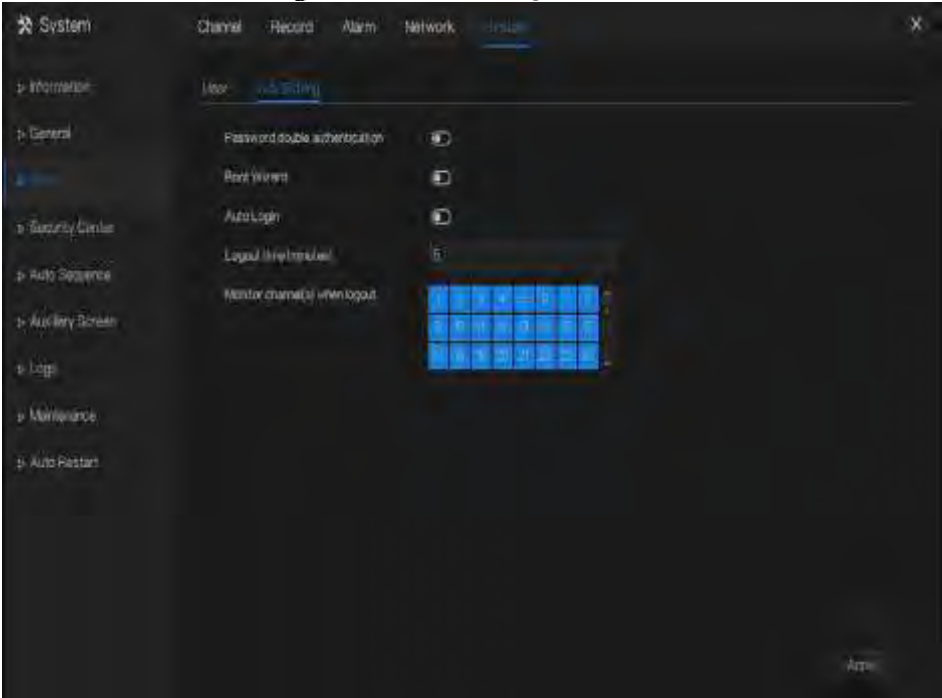

Step 2 Enable or disable Auto login, Password double authentication, Boot Wizard. Set the logout time if the user disable the auto login.

Step 3 Choose monitor channels when logout, the default is all channels.

Step 4 Click **Apply** to save settings.

-----End

7.7.4 Security Center

User can modify the password, pattern unlock, secure email, and secure question..

7.7.4.1 Password

Operation Steps

Step 1 Click **Security Center** in the main menu or menu of the system management screen and choose **Password** to access the modify password screen, as shown in Figure 7-49.

Figure 7-49 Password modification screen

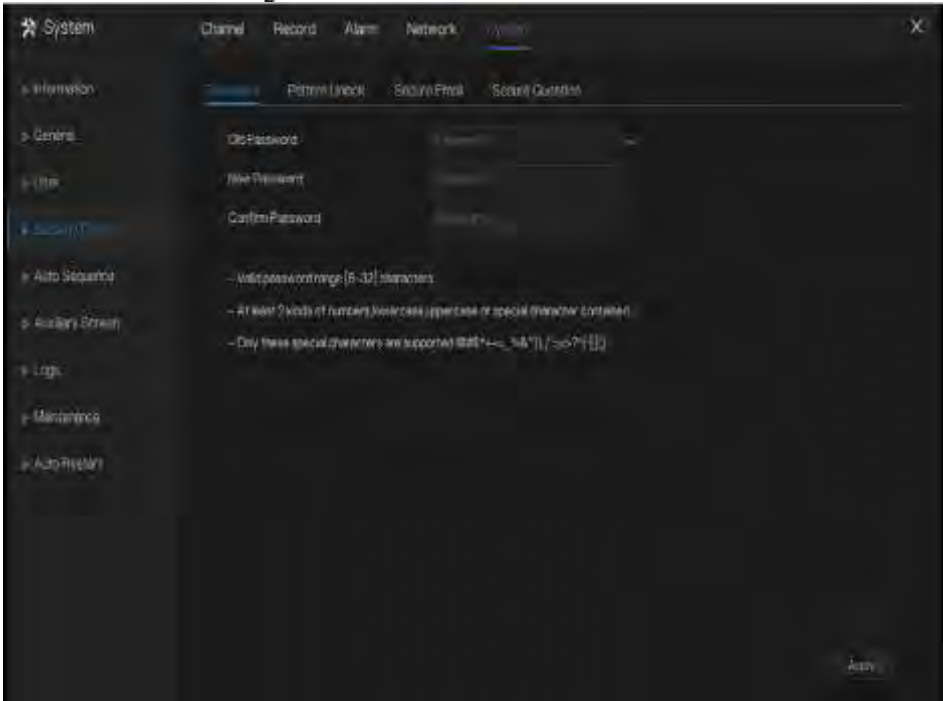

Step 2 Input the correct old password, new password, and confirm password.

NOTE

The password should include at least two kinds of letter, character and number.

The password should be 6~32 characters.

Only special characters (!@#\$%^&*~+=-|_|~<|>|_|) are supported,

Step 3 Click **Apply** to save modified password settings.

----End

7.7.4.2 Pattern Unlock

Operation Steps

Step 1 Click **Security Center** in the main menu or menu of the system management screen and choose **Pattern Unlock** to access the modify pattern unlock screen, as shown in Figure 7-50.

Figure 7-50 Pattern unlock screen

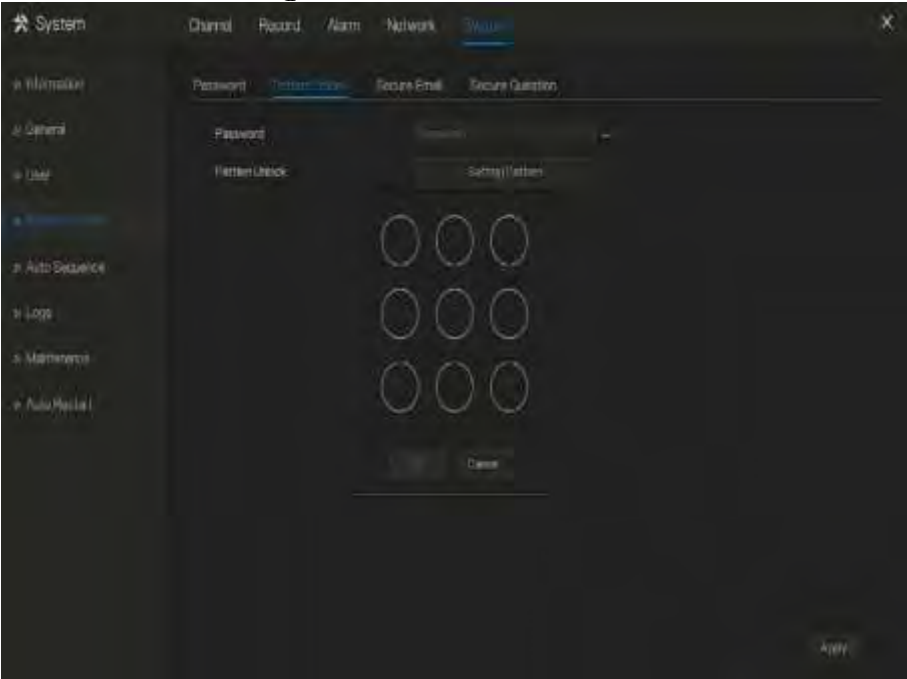

Step 2 Input the password, click **Setting Pattern** to set a new pattern unlock.

Step 3 Draw the pattern, then it will remind to draw the confirmation pattern again.

Step 4 Click **OK** to save the pattern unlock.

----End

7.7.4.3 Secure Email

Set the email to receive the verification code to create new password, as shown in Figure 7-51.

Figure 7-51 Secure Email

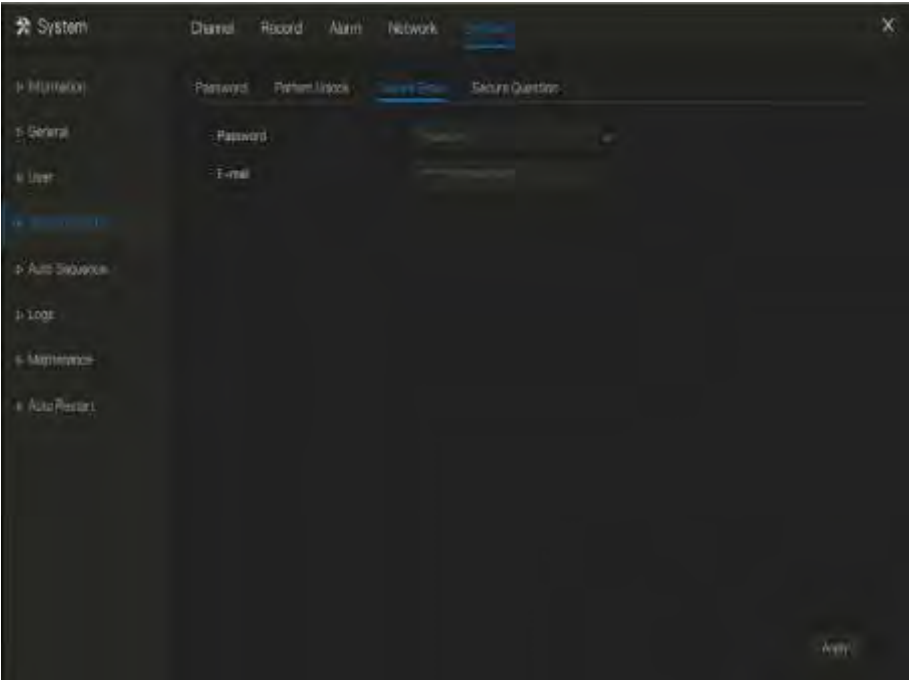

Step 1 Input the password of NVR.

Step 2 Set the Email which will receive email of the verification code.

Step 3 Click **Apply** to save setting.

----End

7.7.4.4 Secure Question

Set the questions to create new password, as shown in Figure 7-51.

Figure 7-52 Secure question

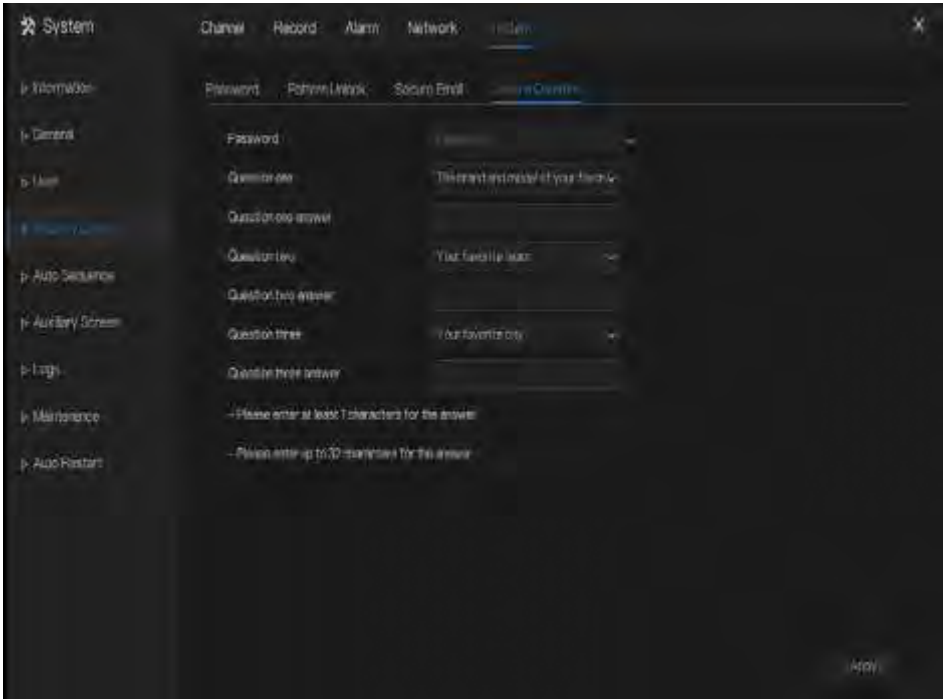

Step 1 Input the password of NVR.

Step 2 Choose the question from drop-down list.

Step 3 Input the answer, click **Apply** to save setting.

----End

7.7.5 Auto Sequence

Set video mode, dwell time in display screen.

Operation Steps

Step 1 Click **Auto Sequence** in the main menu or menu of the system management screen and choose **Auto Sequence** to access the display screen, as shown in Figure 7-53.

Figure 7-53 Auto Sequence screen

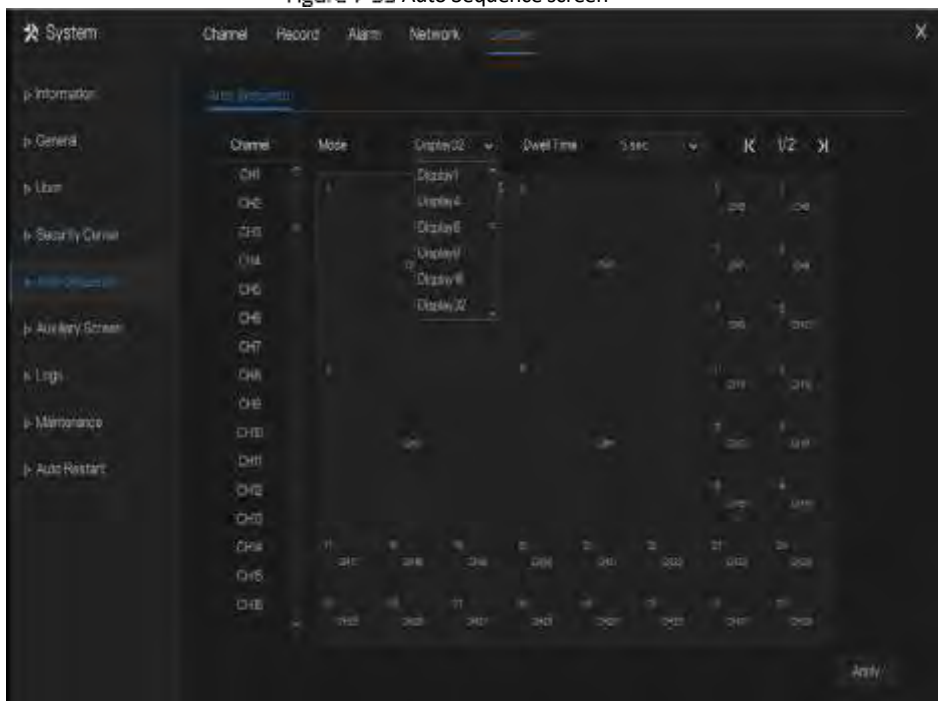

Step 2 Set mode of display. Select a display mode from the **SEQ** drop-down list.

Step 3 Select dwell time from the **SEQ** Dwell time drop-down list(the display screen will loop play the real time video according to setting time).

Step 4 Click **Apply** to save dwell settings.

----End

7.7.6 Auxliary Screen

NOTE

This function only can be used for the devices are 8 or more than channels. The main screen is connected by HDMI(HD-OUT 2), auxiliary screen is connected by VGA.

Operation Steps

Step 1 Click **Auxiliary Screen** in the main menu or menu of the system management screen.

Step 2 Enable the auxiliary screen, as shown in Figure 7-54

Figure 7-54 Auxiliary screen

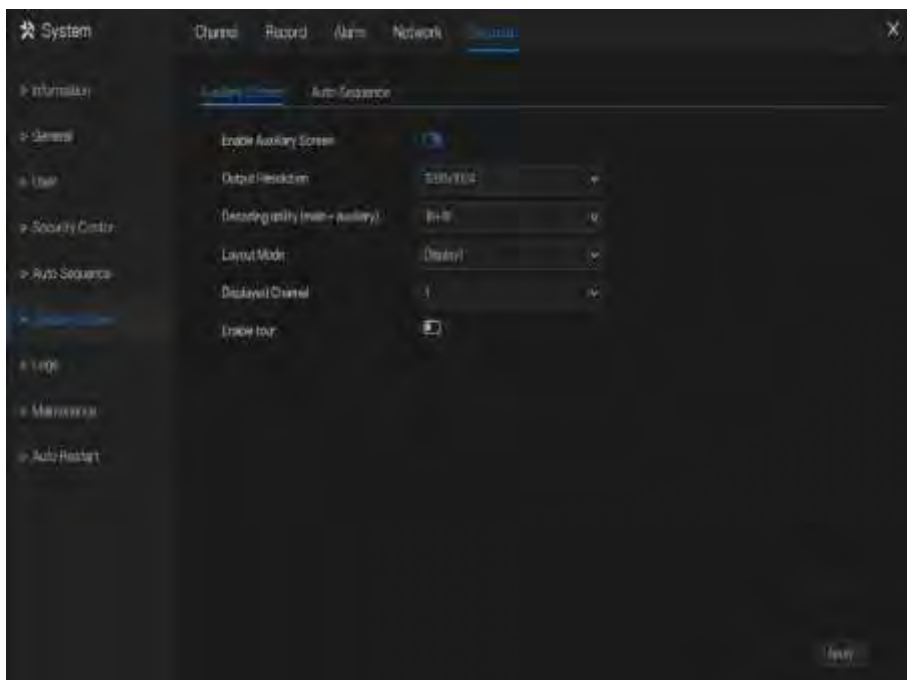

Step 3 Set the Output Resolution, Decoding Ability(main + auxiliary), Layout Mode, Display Channel.

Step 4 Enable tour to set **Auto Sequence** of auxiliary scree as shown in .

Figure 7-55 Auto sequence of auxiliary screen

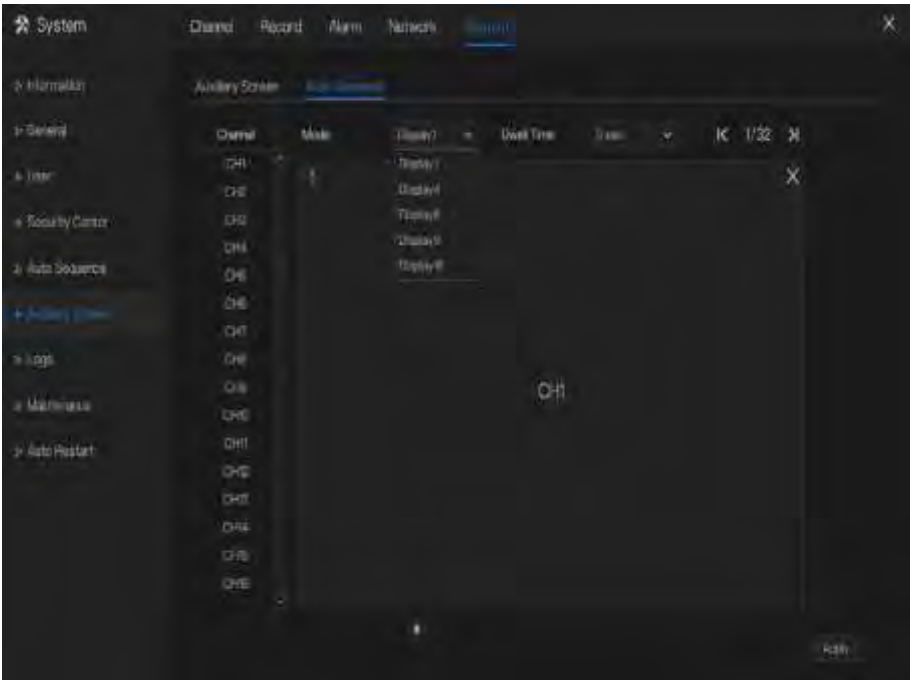

Step 5 Click **Apply** to save settings.



NOTE

The auxiliary screen shows different channels with main screen, and the auto sequence show all channels..

7.7.7 Logs

Search for logs information and export the information.

Operation Steps

Step 1 Click **Logs** in the main menu or menu of the system management screen and choose **Logs** to access the log screen, as shown in Figure 7-56.

Figure 7-56 Log screen

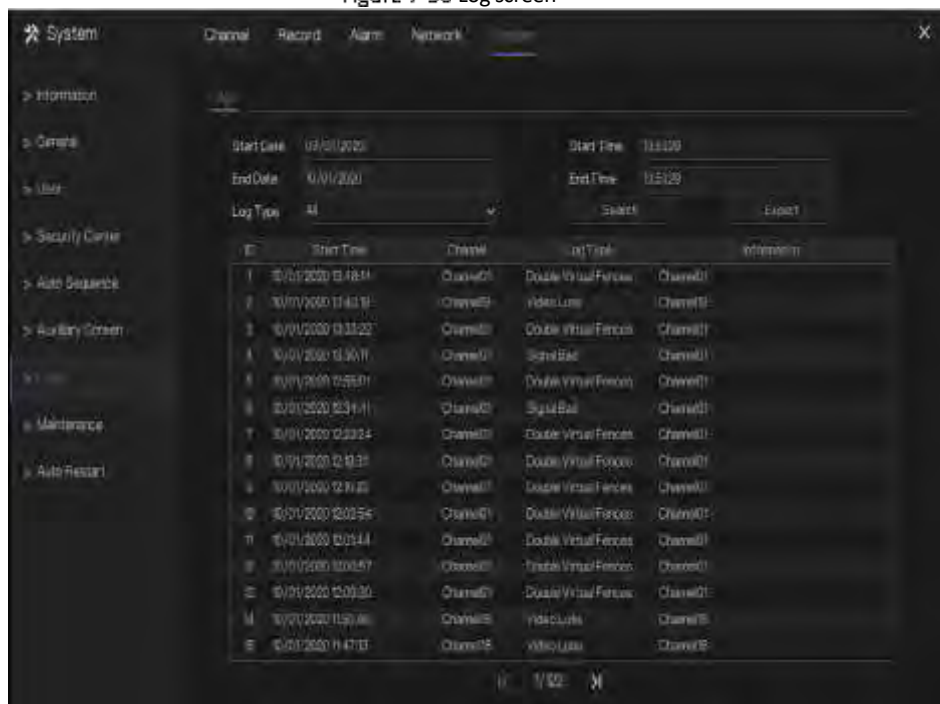

Step 2 Set the logs start date, end date, start time and end time on log screen.

Step 3 Select logs type from the drop-down list.

Step 4 Click **Search** to query logs.

Step 5 Click **Export** to export logs to USB storage.

----End

7.7.8 Maintenance

Operation Steps

Step 1 Click **Maintenance** in the main menu or menu of the system management screen and choose **Maintenance** to access the maintenance screen, as shown in Figure 7-57.

Figure 7-57 Maintenance screen

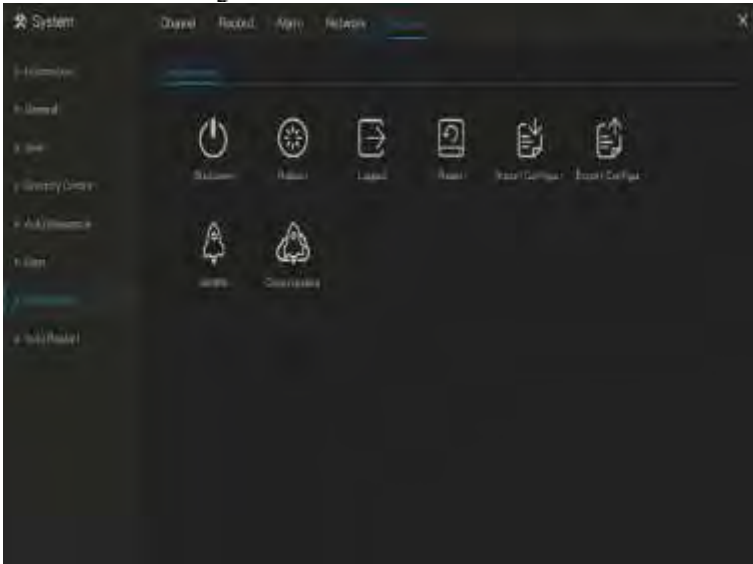

Step 2 Click Shutdown , Reboot , Logout , Exit system, Reset or update to operate NVR if you need.

Step 3 Click import configuration or export configuration to view the message “ **Are you sure to import the configuration?**” user should make flash driver is working.

Step 4 The tip will show on screen, click **ok** to ensure choice.

Step 5 Click **Import Config** to import the configuration to flash drive.

Step 6 Import the configuration, the device would restart immediately.

Step 7 Click **Export Config** to export the configuration from flash drive.

NOTE

When the NVR finishes updating, the device would restart.

----End

7.7.9 Auto Restart

Operation Steps

Step 1 Click **Auto restart** in the main menu or menu of the system management screen and choose **Auto restart** to access the maintenance screen, as shown in Figure 7-57.

Figure 7-58 Auto restart screen

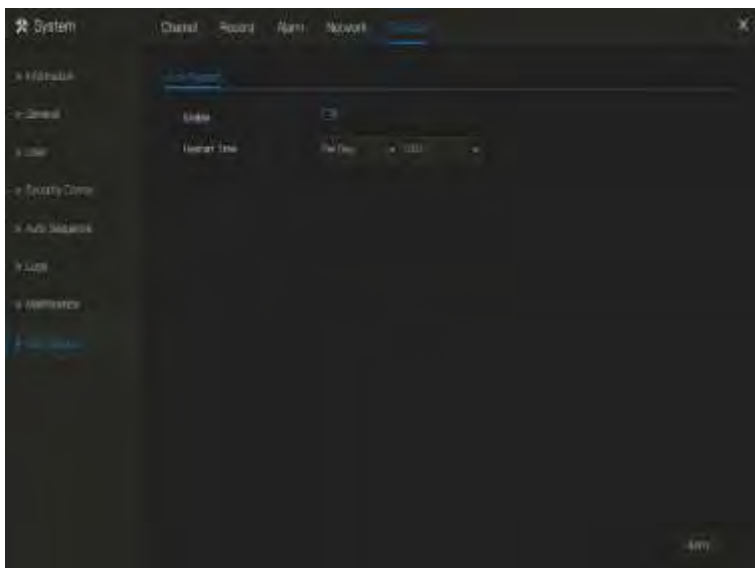

Step 2 Enable the function, restart time is showing as figure 

Step 3 Restart the NVR per day, week or month.

Step 4 Select the restart time from the drop-down list.

----End

8.1 Activation

If you don't set the password at UI interface, user need activate the device, as shown in

Figure 8-1 Activation



Step 1 Set the password, confirm the password.

Step 2 Input the channel password.

Step 3 Set the email of recovery the password.

Figure 8-2 Email

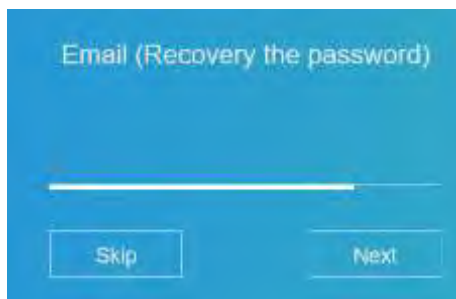

Step 4 Set the question of recovery the password.

Figure 8-3 Question

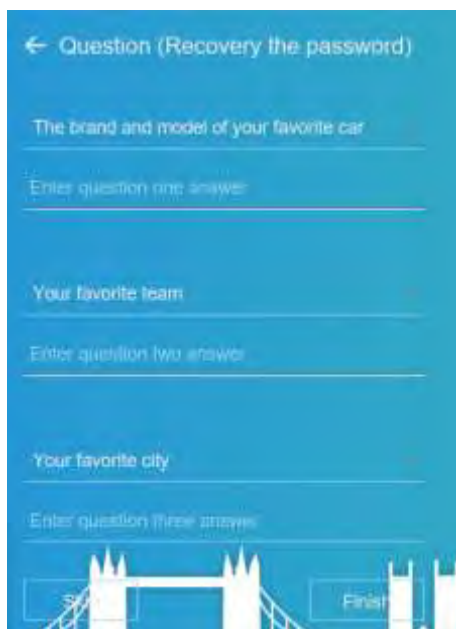

 **NOTE**

If you don't to set the email or question, you can skip the steps.

8.2 Login and Logout



CAUTION

You must use below Firefox 53 or below Chrome 45 to access the Web interface.

Otherwise, the interface functions cannot be used normally.

The win 7/ win 10 system supports IE 8 or more, but the XP system does not.

Browser supports 32 bits.

Descriptions of browser:

To access the client by using Chrome 42-44, you need to enable manually Npapi in the browser according to following steps:

- In the Chrome address bar, enter `chrome://flag/#enable-npapi`.
- Go to the experimental features management page.
- Enable NAPAPI Mac, Windows.
- Click **Enable** (NPAPI plugin is enabled).
- Re-launch Chrome.

Here we take IE 10 as an example for videos viewing.

Login

Step 1 Open IE browser, enter the IP address of the NVR (default value: 192.168.0.121) in the address box, and press **Enter**.

The login page is displayed, as shown in Figure 8-4.

Figure 8-4 Login page interface



Step 2 Input the user name and password.



NOTE

The default user name and password both are admin. The password incorrect more than 3 times, please login again after 5 minutes.

User can change the system display language on the login page.

The modify password page pop-up window would show when login the NVR for the first time.

Step 3 Click **Login** to access the homepage, it would show reminder to download the latest version of the plugin, as shown in Figure 6-4.

Figure 8-5 Download the plugin

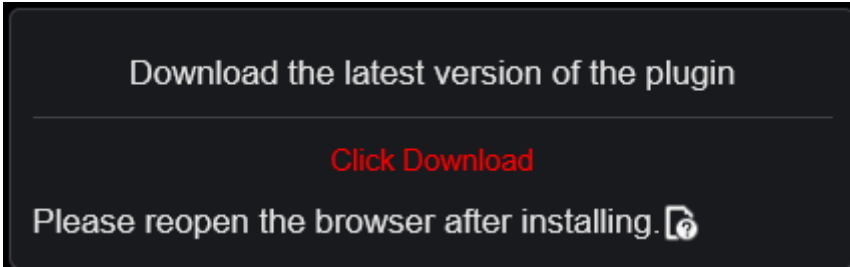

Step 4 Install the latest plugin, reopen the browser and the homepage is displaying as shown in Figure 8-6.

Figure 8-6 Homepage interface

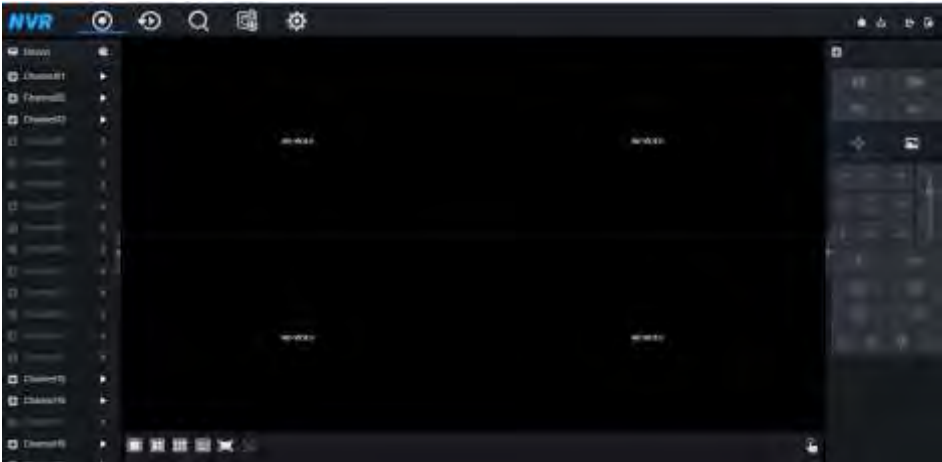

Logout

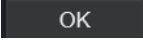
To logout of the system, click  in the upper right corner of the homepage. The pop-up message shows “Do you want to exit?” Click  and the login page will display.

Homepage Layout

NVR allows you to use the Web interface in a PC for implementation of such functions as live video, playback, retrieval, setting, image parameters access, configuration, PTZ control and so

on. Figure 6-6 shows the overall layout of the interface. For descriptions of the interface, please refer to Table 8-1.

Figure 8-7 Homepage layout

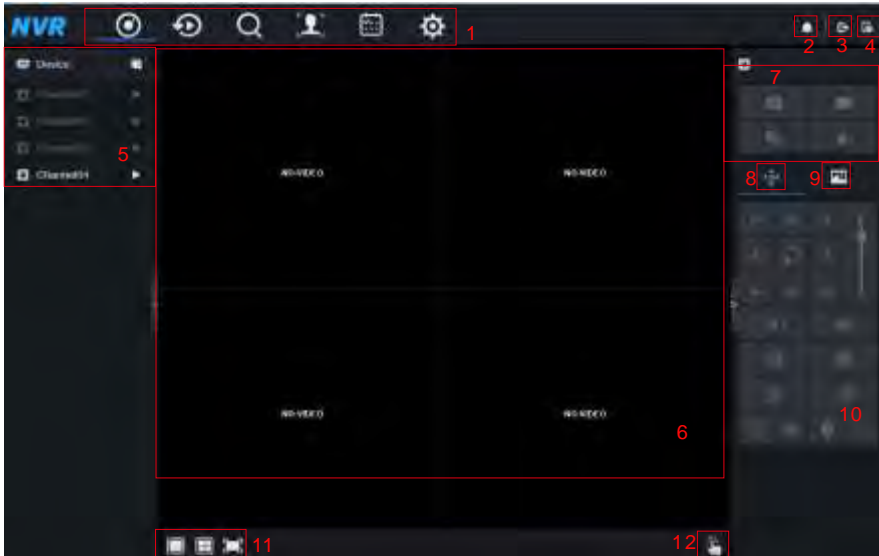





Table 8-1 Descriptions of homepage

No.	Function	Description
1	Function navigation bar	Main functions navigation bar of the device, it includes Live Video, Playback, Alarm Search, Face Recognition, Attendance and System Setting.
2	Alarm	Alarm notification. User can tick pop-up message to monitor, system alarm and channel alarm.
3	Logout button	User can click Logout to exit the current account and return to the login interface.
4	Help	Help for running environment, plug-in installation and activation.
5	Devices list	Display a list of the channels of the managed NVR and the channels managed by NVR.

6	Real-time video	Display the real-time videos of the channels managed by NVR.
7	Channel Operation	Include snapshot, record, stream switch and audio on/off.
8	PTZ control button	 <p>Click  to show PTZ control buttons in zone 10, you can control the PTZ equipment in the current channels.</p> <p>That function only use for IP dome camera.</p>
9	Color parameter button	 <p>Click  to show color parameter setting buttons in zone 9, you can set and adjust the color parameters, for example, brightness, contrast, saturation, and sharpness. Click More to access image settings.</p>
10	Operation zone	The operation zone of PTZ control and image parameter setting.
11	Layouts	Select the one-screen, four-screen, nine-screen or sixteen-screen to switch the layout.
12	Manual alarm	Trigger and close the external alarm device manually.

----End

8.3 Browsing Videos

8.3.1 Browsing Real-Time Videos

You can browse real-time videos in the web management system.

Preparation

To ensure that real-time videos can be played properly, user must perform the following operations when you log in to the web management system for the first time:

Step 1 Open Internet Explorer. Choose **Tools > Internet Options > Security > Trusted sites > Sites**. In the displayed dialog box, click **Add**, as shown in Figure 8-8.

Figure 8-8 Adding a trusted site

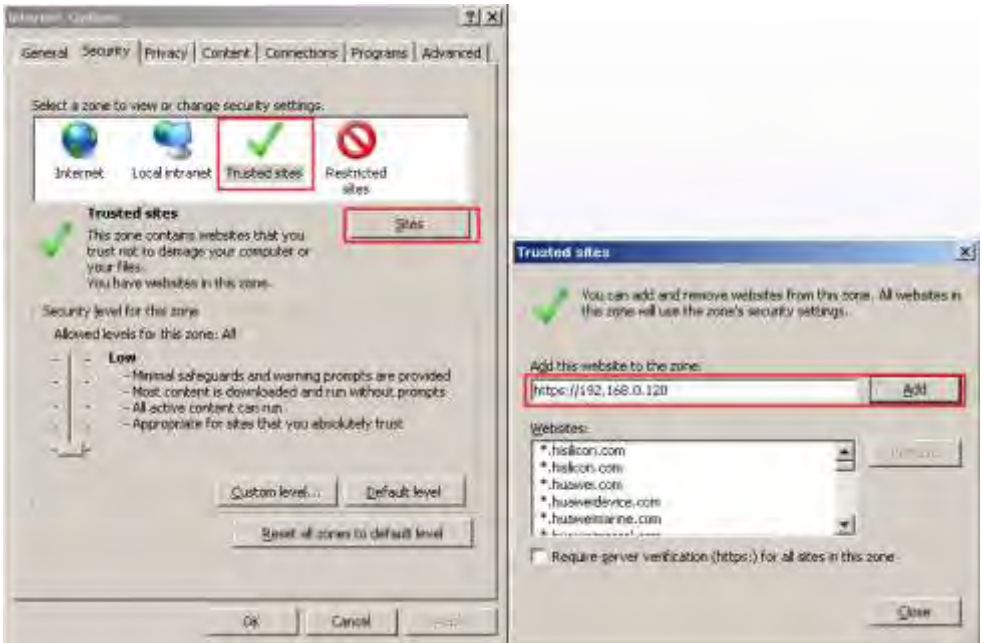

Step 2 In Internet Explorer, choose **Tools > Internet Options > Security > Customer level**, and set Download unsigned ActiveX controls and Initialize and script ActiveX controls not marked as safe for scripting under ActiveX controls and plug-ins to Enable, as shown in Figure 8-9.

Figure 8-9 Configuring ActiveX controls and plug-ins

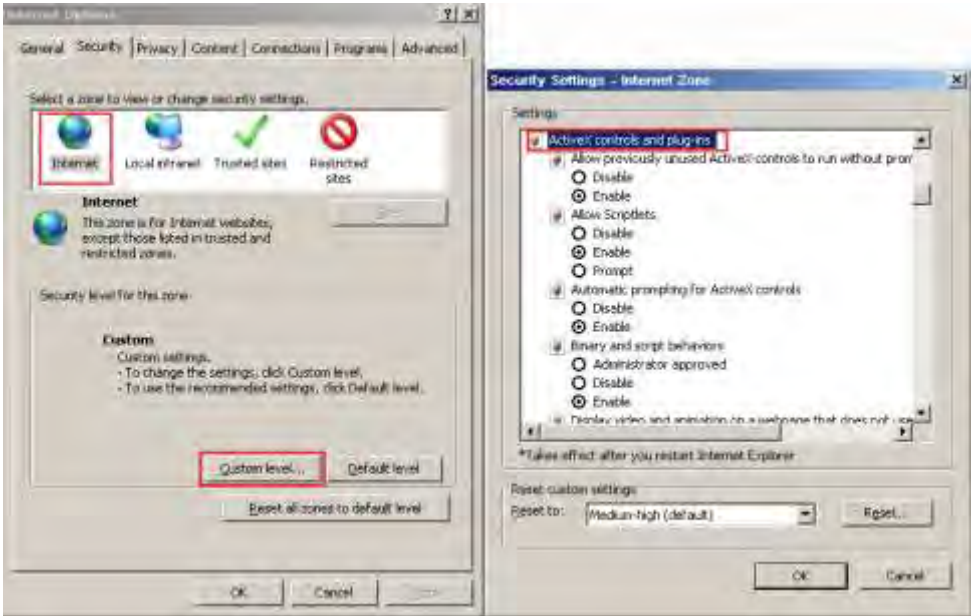

Step 3 Download and install the player control as prompted. During installing, you need to close the browser.



NOTE

If the repair tips displayed when installing the control, close the browser and continue the installation, reopen the login page when the control is installed.

8.3.2 Live Video

Descriptions

After login the device, click online channel, you can view the real-time videos, as shown in Figure 8-10.

Figure 8-10 Real-time videos interface

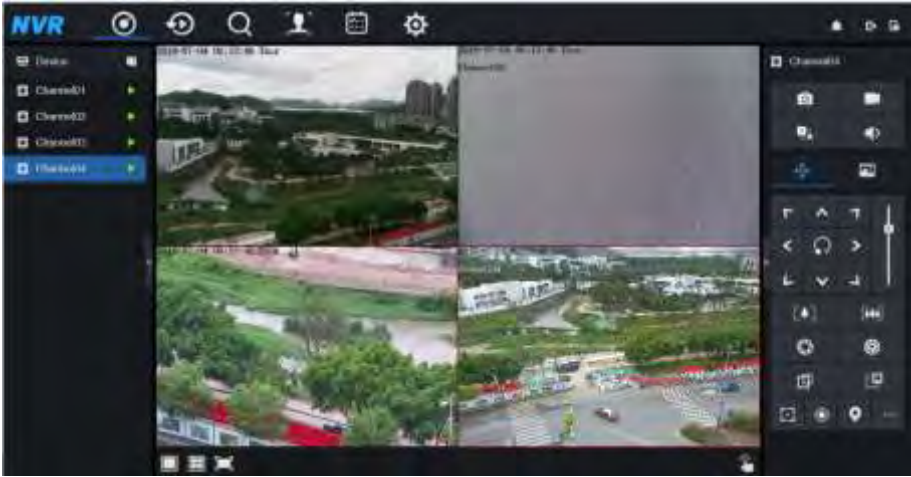





----End

8.3.3 Channel Operation

Descriptions

Channel operation includes snapshot, record, stream switch and audio on/off. Table 8-2 describes the operations.

Table 8-2 Descriptions of homepage

Buttons	Button description	How to operate
	Snapshot	Click button to take snapshots of the current image.
	Record	Click button to start recording and click button again to stop recording.
	Switch stream	Click button to switch stream 1 (main stream) and stream 2(sub stream).
	Enable/Disable video	Click button to enable the audio and click again to disenable the video.

----End

8.3.4 PTZ Control and Setting

Descriptions

The PTZ control and setting function applies only to Network Dome or camera connected to an external PTZ.

PTZ Setting

If a Network Dome or a camera connected to PTZ had been added to the NVR channel, user can control the PTZ rotation to adjust their shooting angle when you are viewing the video. This allows you to perform Omni-directional video surveillance.



Click , the PTZ operation and setting interface is displaying, as shown in Figure 8-11. Table 8-3 describes the operations.

Figure 8-11 PTZ control interface

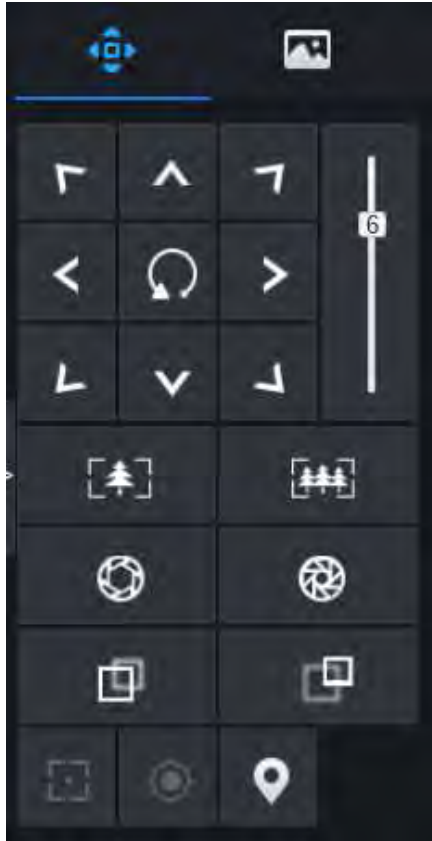













Table 8-3 Device parameters

Buttons	Button description	How to operate
	Direction key	Click button to control omni-directional movement of the PTZ.
	Speed slider	Drag the slider to adjust the value of PTZ rotation speed.

Buttons	Button description	How to operate
	Zoom in	Click buttons to adjust the focal length.
	Zoom out	
	Iris+	Click buttons to adjust the aperture.
	Iris-	
	Far focus	Click buttons to adjust the focal length.
	Near focus	
	Auto focus	Click button to focus automatically.
	Home preset	N/A
	Preset	The camera is set the tour, click the button and dome camera rotate as the setting.
	More	More settings, scan and tour

8.3.5 Sensor Setting

Descriptions





The sensor setting can adjust scene, brightness, sharpness, contrast and saturation, Click  to access image setting, as shown in Figure 8-12. Table 8-4 describes the operations.

Figure 8-12 Image parameter interface



Table 8-4 Device parameters

Buttons	Button description	How to operate
	Brightness	Click button to adjust the image brightness.
	Sharpness	Click button to adjust the image definition.
	Contrast	Click button to adjust the transparency of the image.

Buttons	Button description	How to operate
	Saturation	Click button to adjust the chromatic purity of the image.

Click more will be access to system sensor setting. As shown in Figure 8-13, more detail please refer to *chapter Figure 4-7*.

Figure 8-13 Sensor setting interface



----End

8.3.6 Layout

Click  at the bottom left corner of real-time videos interface, the buttons indicate 1 screen, 4 screens and 9 screens from left to right. More POE port will be 16 screens.

----End

8.4 Playback

8.4.1 Video Playback

Video playback refers to playing of videos stored in local hard disks.

Procedure



Step 1 Click  in the function navigation bar, the video playback interface is displayed, as shown in Figure 8-14.

Figure 8-14 Video playback



Step 2 Select a channel. Click a device in the device list. A selected device is marked with .

An unselected device is marked with .

Step 3 Select a date from calendar at left bottom, the date will be colored if it has record as shown in upper figure.

Step 4 Tick the type of record, such as schedule record, manual record and alarm record.

Step 5 Display videos.

After a device and date are selected, video information is displayed below the video pane. The time scale above the file axis shows the different time points of video recording. The time in blue in the middle is the time of the video playing.

The file axis displays videos. The blue file axis indicates a video exists, grey file axis indicates no video exists.

You can drag the axis to play recording quickly.

Step 6 Play a video.

You can play a video after selecting a device and date. Figure 8-15 shows the control bar of video playback.

Figure 8-15 Control bar

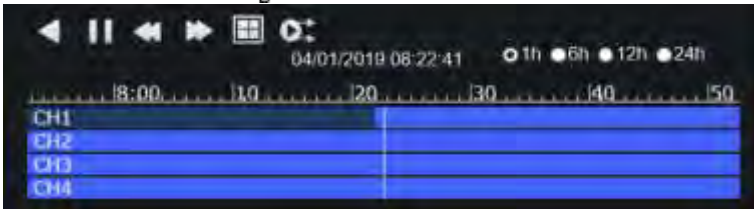

: reversed.

: play/pause.

: triple speed.

: split screen. One or four screens.

: sync/async. You can set the differen channels to play synchronously or asynchronously.

Sync mode indicates the selected channels play video synchronously. Async mode indicates user play different time period record

: types of time bar.

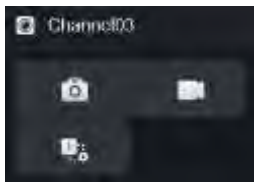

: user can operate the record as same as live video.

---End

8.5 Alarm Search

You can search for channel alarm and system alarm in the alarm search interface.

8.5.1 Channel Alarm

Procedure

Step 1 Click  in the function navigation bar, the channel alarm interface is displayed, as shown in Figure 8-16.

Figure 8-16 Channel alarm interface



Step 2 Click  at the top right corner, select the channel and type, set start time and end time, as shown in Figure 8-17.

Figure 8-17 Set channel alarm

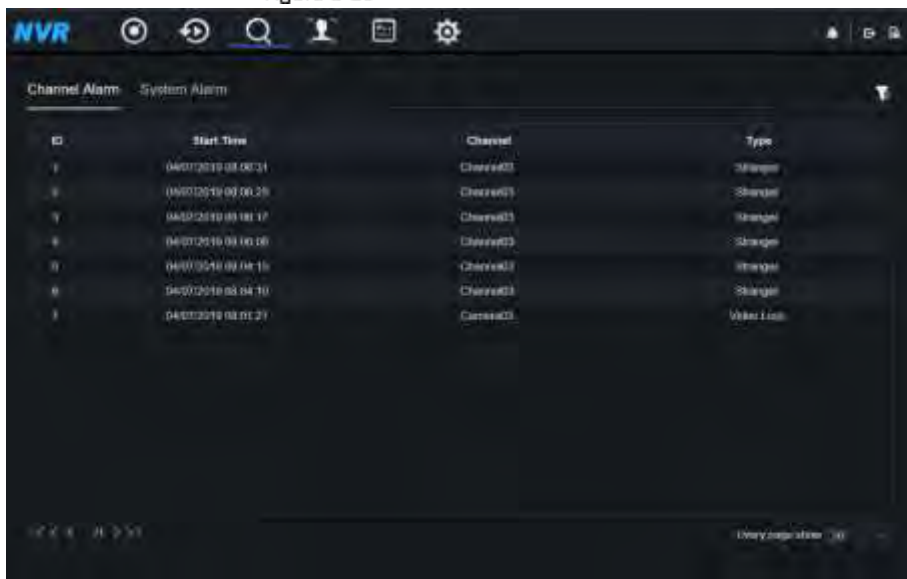
Channel All ▾

Type All ▾

Start Time 2019/01/03 15:13:25

End Time 2019/01/04 15:13:25

Search

Step 3 Click **Search**, the result will be displayed as shown in Figure 8-18.

Figure 8-18 Channel alarm result

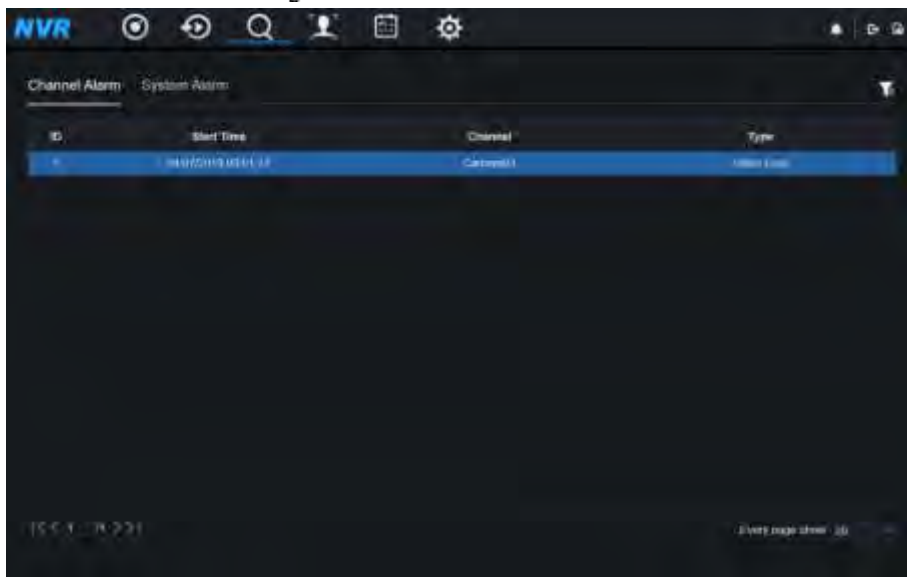

 **NOTE**

Click  to select the page of alarm list.

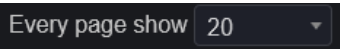
 shows the rows shown in every page.

---End

8.5.2 System Alarm

Procedure

Step 1 Click **System Alarm** in the channel alarm interface, the system alarm is displayed, as shown in Figure 8-19.

Figure 8-19 System alarm result

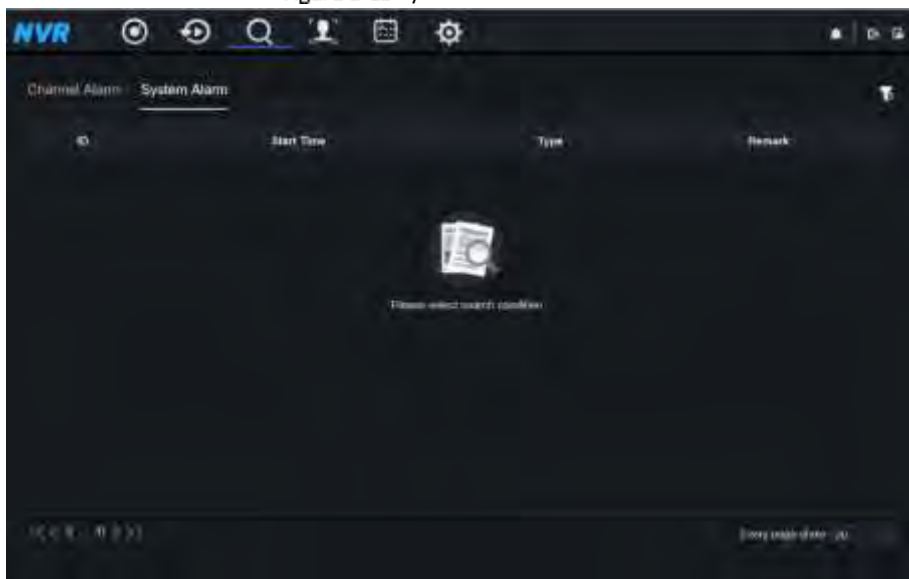

Step 2 Click  at the top right corner, set the channel, type(alarm in and other), start time and end time, as shown in Figure 8-20.

Figure 8-20 Search system alarm

Type

Start Time

End Time

Step 3 Click **Search**, the result will be displayed.

----End

8.6 Attendance

The function is only applicable for NVR2604E1-P4C-J and NVR2608E1-P8C-J

8.6.1 Attendance Data

Click to enter attendance data interface, as shown in Figure 8-21.

Figure 8-21 Attendance data

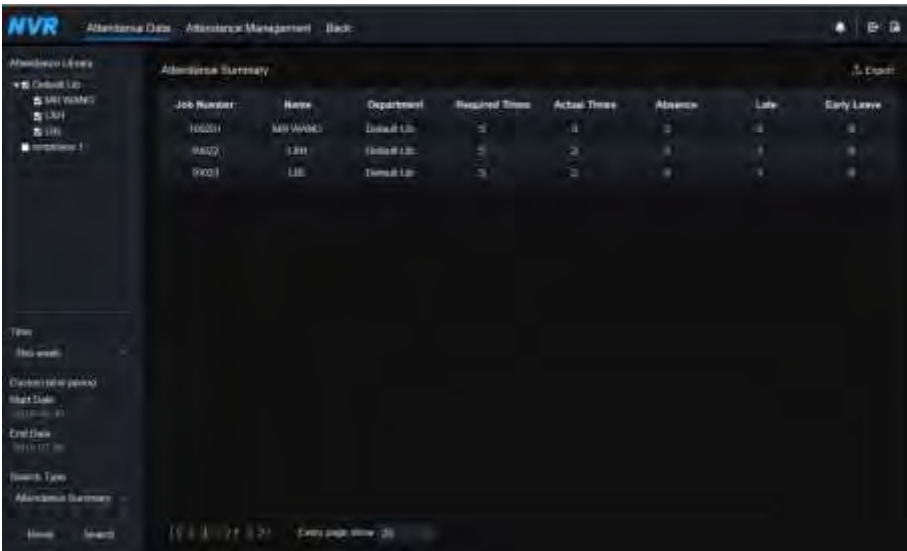

The screenshot shows the NVR Attendance Data interface. On the left is a sidebar with navigation options like 'Attendance Library', 'Time', 'Check-in (after parking)', 'Start Date', 'End Date', and 'Search Type'. The main area displays an 'Attendance Summary' table with columns for Job Number, Name, Department, Required Times, Actual Times, Absence, Late, and Early Leave. The table contains three rows of data.

Job Number	Name	Department	Required Times	Actual Times	Absence	Late	Early Leave
10001	Mr. Wang	Dept. A	5	4	1	0	0
10002	Mr. Li	Dept. B	5	5	0	1	0
10003	Mr. Zhang	Dept. C	5	5	0	0	0

Operation Steps

Step 1 Tick the attendance library.

Step 2 Choose time mode, such as today, this week, this month and custom time.

Step 3 Choose search type, such as attendance summary and attendance details.

Step 4 Click search, the result will show in interface.

Step 5 Click Export to export the query result.

8.6.2 Attendance Management

In attendance management, user can set attendance rule, library and check point, as shown in Figure 8-22.

Figure 8-22 Attendance rule settings



Operation Steps

Step 1 Set start work time and end work time.

Step 2 Tick the workday

Step 3 Set valid time of check in and check out.

Step 4 Click Save to save the setting.

Attendance library

Step 1 Click **Attendance Library** to add library, the attendance library can call the face database directly.

Figure 8-23 Attendance library



Step 2 Tick the library and click **Add** to add to attendance library. If you want to modify the library, please enter to library interface to change parameters..

Step 3 click  **Database management** to enter the face database management to modify parameter.

Step 4 Click **Save** to save the setting.

Attendance check point settings:

Step 1 Click Attendance check point settings to set point, as shown in Figure 8-24.

Figure 8-24 Attendance check point setting



Step 2 Click  to edit check point setting, as shown in Figure 8-25

Figure 8-25 Check point



Step 3 Enable the function, set similarity and tick the library, all face detection cameras can be set the check points

Step 4 Click OK to save the setting.

8.7 AI Recognition

At AI recognition interface, we can set the **Real time Comparison, Smart search, Archives library, Comparison configuration.**

8.7.1 Real Time Comparison

Real time comparison can compare human face, vehicle license plate, and AI(include riding, vehicle, full body)

8.7.1.1 Human Face

At real time comparison interface, click the  to enter the human face comparison interface, choose the cameras with face recognition function to play live video, the snapshot of camera will compare with libraries, the result shows as in Figure 8-26.

Figure 8-26 Human face comparison



Click the “+” can add the snapshot to face library immediately.

8.7.1.2 Vehicle License Plate

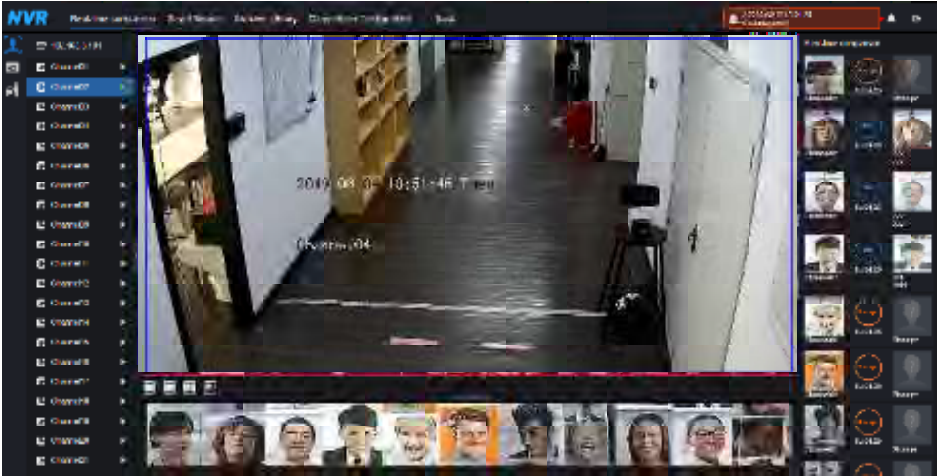

At real time comparison interface, click the  to enter the vehicle license plate comparison interface, choose the cameras with license plate recognition function to play live video, the snapshot of camera will compare with libraries, the result shows as in Figure 8-27.

Figure 8-27 Vehicle license plate

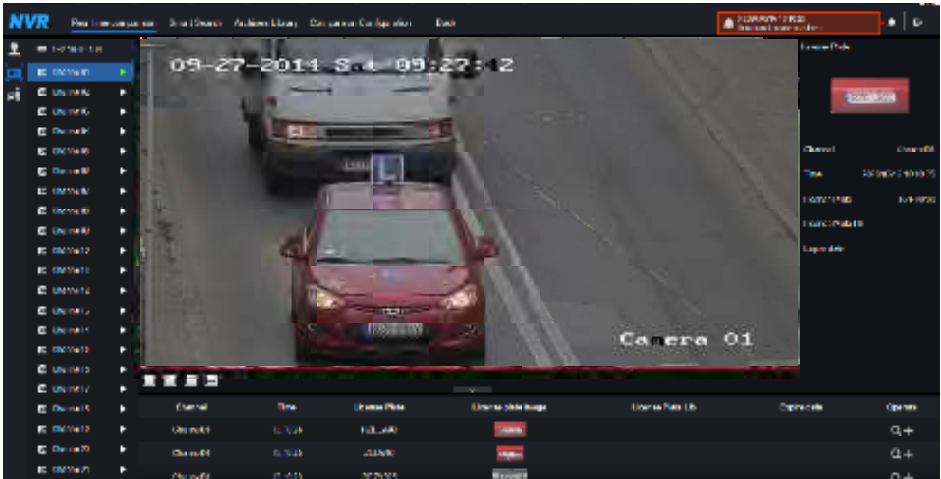

Click the “+” can add the snapshot to license plate library immediately.

Snapshot in real time video, put the cursor on picture such as , you can add it to face library, or face search. The cursor on area 6 and the pictures is not update, move the mouse so that the pictures can be shown in time.

8.7.1.3 Vehicle and Full Body

At real time comparison interface, click the  to enter the vehicle license plate comparison interface, choose the AI recognition cameras to play live video, the snapshot of camera will compare with libraries, the snapshot to vehicle and full body will show at the bottom of page, the result shows as in Figure 8-28.

Figure 8-28 Full body



8.7.2 Smart Search

At smart search interface, user can search the human face, vehicle license plate, full body, car, body temperature.

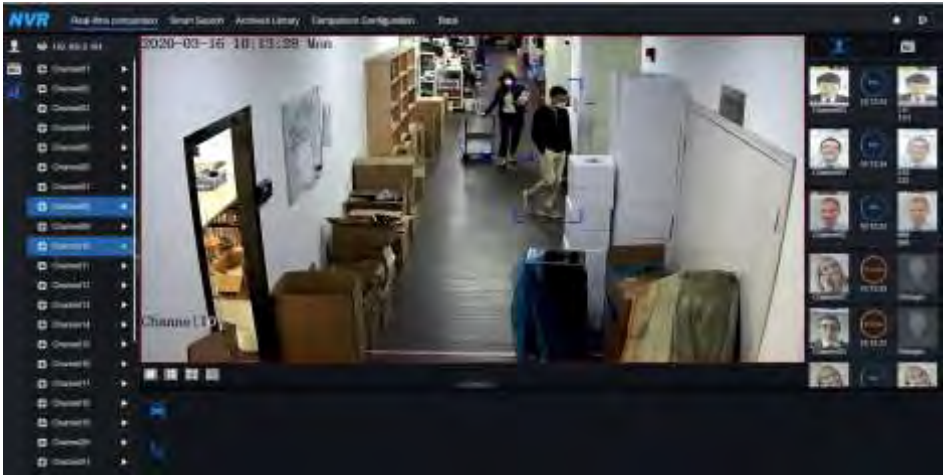
8.7.2.1 Human Face Search

Figure 8-29 Human face search



Step 1 Choose human face search at smart search interface.

Step 2 Tick the face recognition camera channels, set the start time and end time.

Step 3 Choose the condition (by picture or by feature), the picture can be chosen from the file folder.

Step 4 Click "Search" to search the snapshot of human face.

Step 5 The result will show at the middle of page, click the picture and the detail information will show at the top right of page.

Step 6 The detail picture can be used to search or add to library.

Step 7 Click play button of video to play the recording of snapshot.

8.7.2.2 Vehicle License Plate Search

Figure 8-30 Vehicle License Plate search



Step 1 Choose vehicle License Plate at smart search interface.

Step 2 Tick the vehicle license plate recognition camera channels, set the start time and end time.

Step 3 Input the license plate optionally.

Step 4 Click “Search” to search the snapshot of license plate.

Step 5 The result will show at the page, click “+” add to library.

8.7.2.3 Full Body Search

Figure 8-31 Full body search



- Step 1 Choose full body search at smart search interface.
- Step 2 Tick the AI recognition camera channels, set the start time and end time.
- Step 3 Set the gender , click cycling or no cycling .
- Step 4 Click “Search” to search the snapshot of human face.
- Step 5 The result will show at the middle of page, click the picture and the detail information show at the top right of page.
- Step 6 Click play button of video to play the recording of snapshot.

8.7.2.4 Vehicle Search

Figure 8-32 Vehicle search

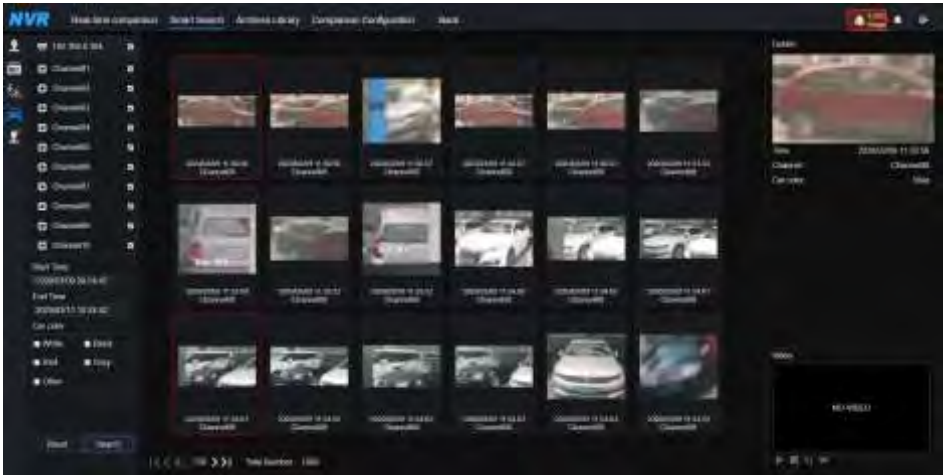

Step 1 Choose vehicle search at smart search interface.

Step 2 Tick the AI recognition camera channels, set the start time and end time.

Step 3 Tick the color

Step 4 Click “Search” to search the snapshot of human face.

Step 5 The result will show at the middle of page, click the picture and the detail information show at the top right of page.

Step 6 Click play button of video to play the recording of snapshot.

8.7.2.5 Body Temperature Search

Figure 8-33 Body temperature search



Step 1 Choose body temperature search at smart search interface.

Step 2 Tick the AI recognition camera channels, set the start time and end time.

Step 3 Choose the person type, temperature type, input ID optionally.

Step 4 Click “Search” to search the temperature.

8.7.3 Archives Library

At archives library, user can add or edit the face library , license plate library.

8.7.3.1 Face Library

Figure 8-34 Face library

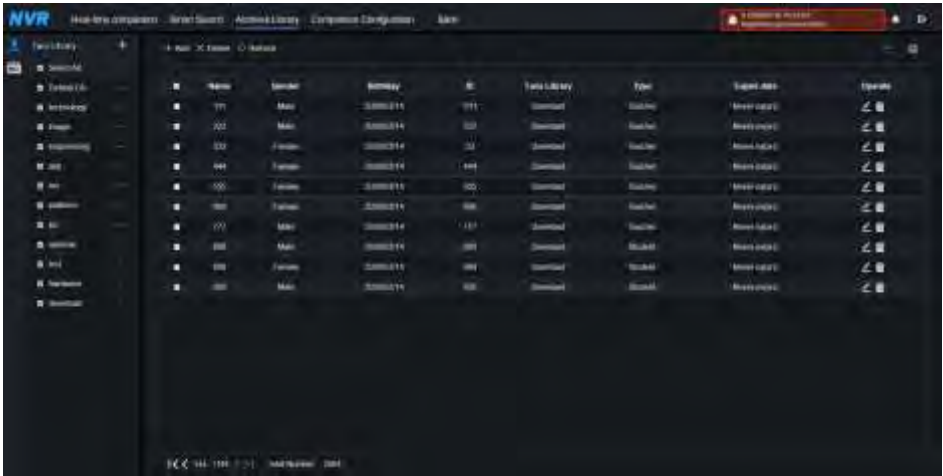

- Click “+” to add face library.
- Click “Add” to add person enroll.
- Tick the person, click “Delete” to delete the person.
- Click “Import” to add the person batch.
- Click “Export” to export the all person in library.
- Click operate icon to edit or delete the chosen person.

Snapshot in real time video, put the cursor on picture such as , you can add it to face library, or face search. The cursor on area 6 and the pictures is not update, move the mouse so that the pictures can be shown in time.

8.7.3.2 License Plate Library

Figure 8-35 License plate library



Click “+” to add license plate library.

Click “Add” to add plate to library.

Tick the plate , click “Delete” to delete the license plate.

Click “Import” to add the license plate batch.

Click “Export” to export the all license plate library.

Click operate icon to edit or delete the chosen license plate.

8.7.4 Comparison Configuration

At comparison configuration interface, user can set the comparison of human face/ license plate/temperature.

Figure 8-36 Face comparison



At face comparison interface, user can set different channels' strategy, such as similarity, display comparison result, face library, enable alarming, event action, arming time, as shown in Figure 6-39 .

Figure 8-37 License comparison

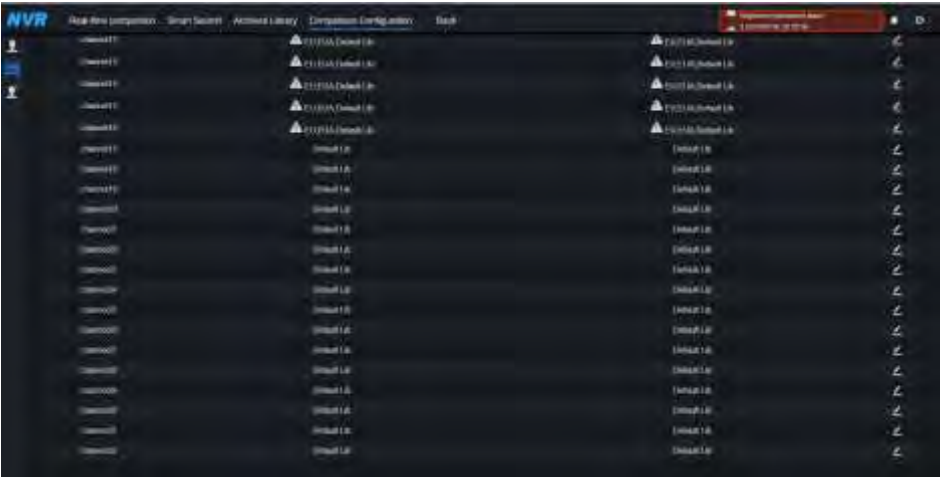

At license plate interface, user can set strategies of different channels of license plate recognition cameras, such as register and unregister, enable alarming, event action, arming time, as shown in Figure 8-37.



means the library is deleted.

Figure 8-38 Temperature comparison

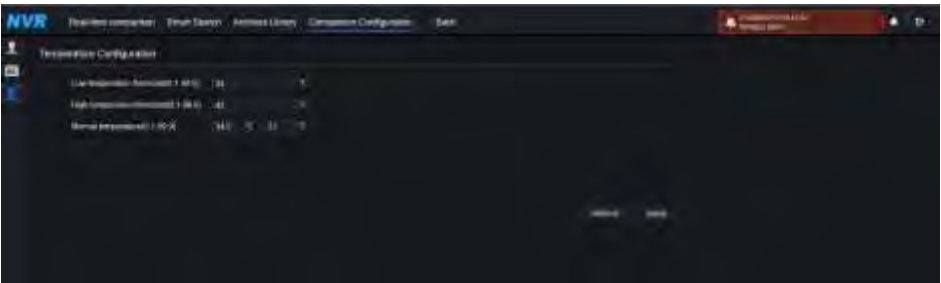

At temperature comparison interface, user can set low temperature threshold, high temperature threshold, normal temperature, as shown in Figure 8-38.

Figure 8-39 Strategy



9 System Setting

The system setting allows you to set system, channel, record, alarm, network and local setting.

9.1 Channel

User can set parameter about camera, encode, sensor setting, OSD and privacy zone.

9.1.1 Camera

Step 0 On the **System Setting** screen, choose **Channel > Camera** to access the camera interface, as shown in Figure 9-1.

Figure 9-1 Camera interface



Step 1 Input username and password (the default value both are admin), and click

Click To Add

add cameras automatically.

Step 2 Click **Search** to search cameras at the same LAN as NVR, as shown in Figure 9-2.

Choose the camera, input username and password, click **Add** to add new camera.

Figure 9-2 Device search

ID	IP Address	Port	Model	Protocol	Firmware Version
1	192.168.99.14	30001	IP55730B0C6025B33028	Private	3.0.0804.1004.3.0.6.12.0
2	192.168.70.177	30001	CB1011-W	Private	v3.0.0818.3800.172.0.31.0.105
3	192.168.70.178	30001	CB1041-W	Private	v3.0.0818.3800.172.0.31.0.105
4	192.168.10.249	30044	IP55730B0C6025B33023	Private	v3.0.0818.1004.3.0.33.3.0
5	192.168.10.208	30001	SN-TSL13	Private	3.0.0635.1004.3.0.13.4.0
6	192.168.10.127	-89		DNVIF	-----
7	192.168.10.128	-89		DNVIF	-----
8	192.168.10.8	30001	SN-IP153218ZAN-J5-Z3.7-13.5-13	Private	3.0.0804.1004.3.0.6.00.0

Step 3 Click **Back** to back to camera interface.

Step 4 Click **Refresh** to refresh cameras status.

Step 5 Choose the cameras and click **Delete** to delete.

Step 6 Click **Batch Update** to update all selected cameras at once, the pop-up window would show to select software.





Step 7 Click  to modify the information of device parameters, as shown in Figure 9-3.

Figure 9-3 Modify device parameters



Step 8 Click  to access web immediately.

Step 9 Click  to update, reboot or reset the selected camera, as  shows.

The pop-up message “Are you sure to restart the device?” “Are you sure to reset? Reserve IP Address” would respectively show.

 **NOTE**



: it indicates the camera is online, user can view the live video immediately.



: it indicates the camera is offline, it maybe not connect the network, or the password is incorrect. User access to the modify device parameters interface to change.

9.1.1.1 Protocol Management

Set the protocol management, user can add different protocol cameras to NVR

Figure 9-4 Protocol management

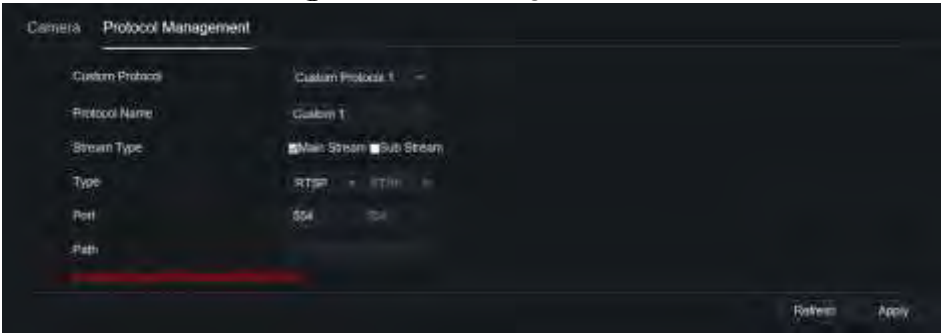

Step 1 Click **Channel > Camera > Protocol Management**.

Step 2 Choose the custom protocol from the drop-down list, there are 16 kinds of protocols can be set.

Step 3 Input the protocol name.

Step 4 Tick main stream and sub stream. The main stream shows image on full screen live video. The sub stream shows image on split screen. If you just tick main stream and the channel will not show image on split screen.

Step 5 Choose the type of protocol, the default value is RTSP.

Step 6 Input the port, it depends the IP camera.

Step 7 Input the path, it depends the manufacturer of cameras.

Step 8 Click **Apply** to save the settings.

9.1.2 Encode

Step 1 On the **System Setting** screen, choose **Channel > Encode** to access the encode interface, as shown in Figure 9-5.

Figure 9-5 Encode interface

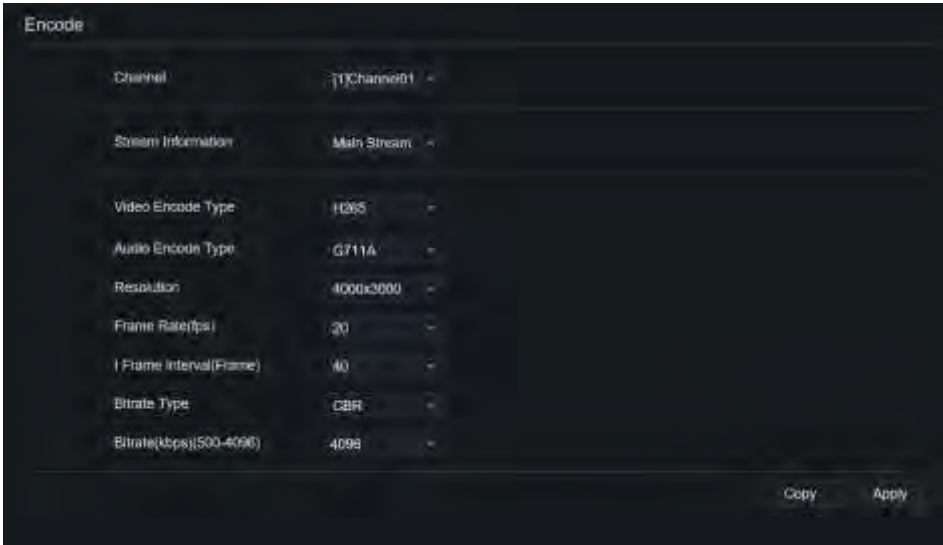

Step 2 Select a channel from drop-down list.

Step 3 Select stream information, encode type, resolution, frame rate, bitrate control and bitrate from drop-down list.

Step 4 Click **Copy** to choose other camera to copy settings. Click **Apply** to save the settings.

----End

9.1.3 Sensor Setting

Step 1 On the **System Setting** screen, choose **Channel >Sensor Setting** to access the sensor setting interface, as shown in Figure 9-6.

Figure 9-6 Image interface



Step 2 Select a channel and scene from drop-down list.

Step 3 Set image parameters, like scene, brightness, sharpness, contrast and saturation.

Step 4 Other parameters are camera's sensor setting, user can refer IP cameras' settings.

Step 5 Click **Copy** to choose other camera to copy settings. Click **Apply** to save the settings.

 **NOTE**

Brightness: It indicates the total brightness of an image. As the value increases, the image becomes brighter.

Sharpness: It indicates the border sharpness of an image. As the value increases, the borders become clearer, and the number of noise points increases.

Saturation: It indicates the color saturation of an image. As the value increases, the image becomes more colorful.

Contrast : It indicates the measurement of different brightness levels between the brightest white and darkest black in an image. The larger the difference range is, the greater the contrast; the smaller the difference range is, the smaller the contrast.

Scene: it includes indoor, outdoor, default. Mirror includes normal, horizontal, vertical, horizontal + vertical.

Exposure: it includes mode, max shutter, meter area and max gain.

White balance: it includes tungsten, fluorescent, daylight, shadow, manual, etc.

Day-night: user can transit day to night, or switch mode.

Noise reduction: it includes 2D NR and 3D NR.

Enhance image: it includes WDR, HLC, BLC, defog and anti-shake.

Zoom focus: user can zoom and focus.

----End

9.1.4 OSD

Step 1 On the **System Setting** screen, choose **Channel >OSD** to access the OSD interface, as shown in Figure 5-4

Figure 9-7 OSD interface



Step 2 Select a channel and scene from drop list.

Step 3 Enable time and channel name. You can set channel name. Drag the icon of Channel Name or Date and Time to move, select the location.

Step 4 Click **Copy** to choose other camera to copy settings. Click **Apply** to save the settings.

----End

9.1.5 Privacy Zone

Step 1 On the **System Setting** screen, choose **Channel >Privacy Zone** to access the privacy zone interface, as shown in Figure 9-8.

Figure 9-8 Privacy interface



Step 2 Select a channel from drop-down list .

Step 3 Drag the mouse to select area to cover with rectangle frame. You can set less than four areas to be covered. Double click would delete the area.

Step 4 PTZ can be used for adjusting the IP dome cameras.

Step 5 Click **Copy** to choose other camera to copy settings. Click **Apply** to save the settings.

----End

9.2 Record

Users can set record policy in storage interface.

9.2.1 Record Schedule

Procedure

Step 1 On the **System Setting** screen, choose **Record > Record schedule** to access the record schedule interface, as shown in Figure 9-9.

Figure 9-9 Record schedule interface

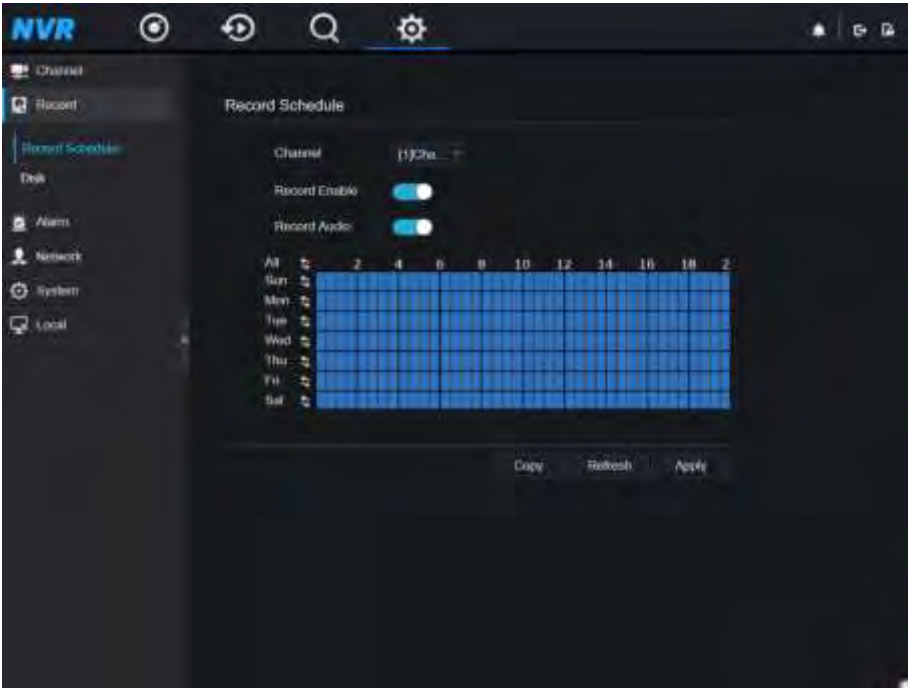

Step 2 Select a channel .

Step 3 Enable the record, then enable record audio.

Step 4 Set the record schedule, you can drag the mouse to choose area, click  to choose all day or all week, you can also click one by one to set the schedule. Or dray the mouse cursor to choose.

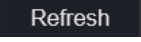
Step 5 Click  to return the previous settings.

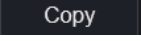
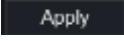
Step 6 Click  to choose other camera to copy settings. Click  to save the settings.

----End

9.2.2 Disk

Step 1 On the **System Setting** screen, choose **Record >Disk** to access the disk interface, as shown in Figure 9-10.

Figure 9-10 Disk interface



Step 2 You can view the information like capacity, disk status, disk SN code and used space.

Step 3 Click **Format** to delete all data. Before deleting data user will view pop-up window

“Are you sure to format disk? Your data will be lost”. Click **OK** to delete, click

Cancel to quit.

Step 4 Choose the disk group from drop-down list, there are four disk group.

Step 5 If the recording overwrite is disable, user need to set the expired time, it is up to 90 days.

----End

9.2.3 RAID

 **NOTE**

RAID is only used for the device with 4 disks or more. And the disks must be enterprise level disks. The capacity of disks are better same for efficient using.

RAID5 at least 3 disks can be created. RAID6 at least 4 disks can be created. RAID10 at least 4 disks can be created. Create hot spare disk need more one disk or double basic disks.

The capacity of disks are better same for efficient using.

Figure 9-11 RAID

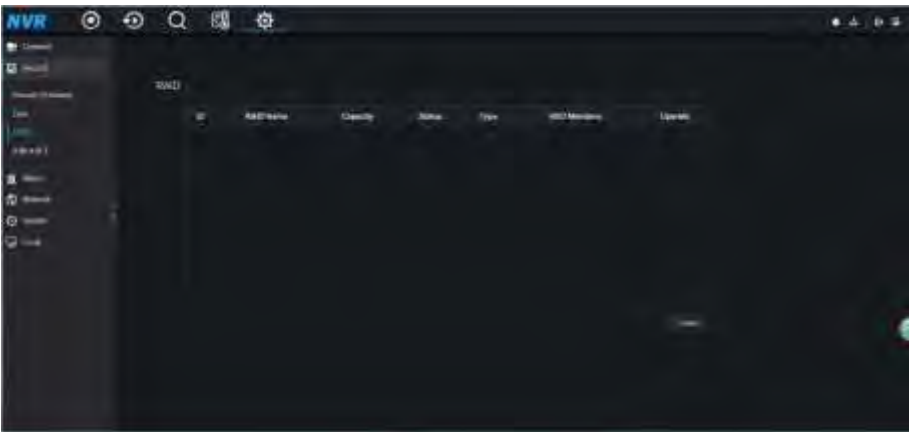

Operation Steps

Step 1 Click **RAID** to create the RAID.

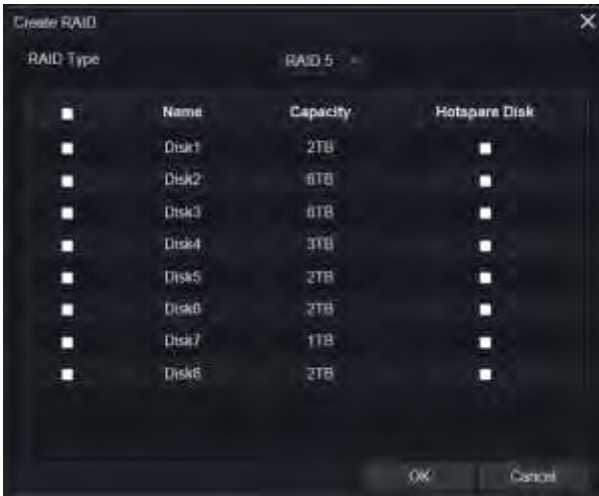

Step 2 Click **Create** to choose disk to create a new RAID.

Step 3 Tick the **Hot-spare Disk** to back up the broken disk in case, the number of disk must more than basic disks.

Step 4 Click **OK** to save the creation, format the new RAID



Step 5 click **format it will show**



Figure 9-12 Modify the RAID

ID	Name	Capacity	Status	Type	Hotspare	Operate
1	Disk1	3TB	Active	RAID 5	No	
2	Disk2	3TB	Active	RAID 5	No	
3	Disk3	3TB	Active	RAID 5	No	
4	Disk4	3TB	Active	RAID 5	No	
5	Disk5	2TB	Spare	RAID 5	Yes	+
6	Disk6	3TB		HEC		+
7	Disk7	3TB		HEC		+
8	Disk8	3TB		HEC		+

9.2.4 S.M.A.R.T

S.M.A.R.T is Self-Monitoring Analysis and Reporting Technology, user can view the health of disk, as shown in Figure 9-13.

Figure 9-13 S.M.A.R.T

ID	Attribute Name	Status	Value	Worst	Threshold	Type	Raw value
1	raw-read-error-rate	OK	718	01	0	read	0c1b004200000
2	start-to-err	OK	80	05	0	read	d000000000000
4	start-to-err-cnt	OK	100	100	20	err-ctr	0a70000000000
5	reallocated-sector-count	OK	000	000	10	read	0a70000000000
7	seek-err-rs	OK	01	00	30	read	0a01000000000
8	power-on-hours	OK	01	01	0	hrs-age	0a00000000000
11	spin-err-cnt	OK	000	000	01	read	0a00000000000
12	power-loss-cnt	OK	000	000	20	hrs-age	0a01000000000
184	end-to-err-err	BAD	01	01	00	hrs-age	0a00000000000
187	reported-unsett	OK	00	00	0	hrs-age	0a00000000000
188	current-temp	OK	000	01	0	hrs-age	0a25000000000
189	total-bytes-wr	OK	1	1	0	hrs-age	0a00100000000

9.2.5 Storage Mode

User is based on need to distribute the channels to different disk group, and use disk capacity reasonably.

Figure 9-14 Storage Mode

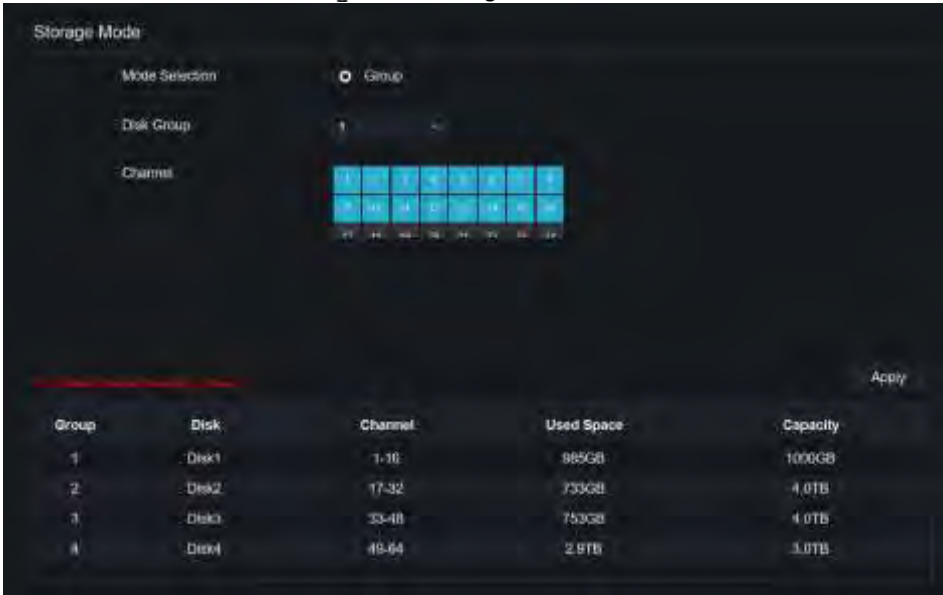

Operation Steps

- Step 1 Choose the disk group.
- Step 2 Select the channel to record to disk group.
- Step 3 Click Apply to save the settings.
- Step 4 The group list will show the detail information.

9.2.6 Cloud Storage

User copy the authorization code path to browser to enter Google Drive interface. Google send the code, and user input the code to authority NVR, so the device can set the alarm recording to Google drive.

Figure 9-15 Cloud Storage

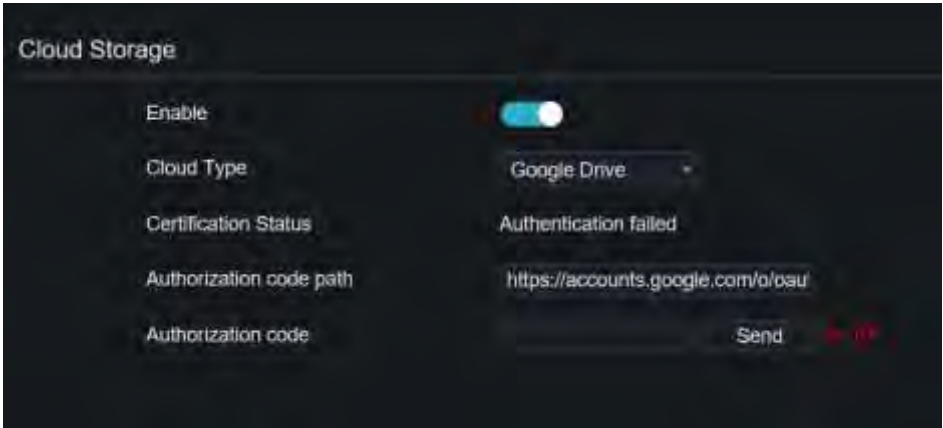

NOTE

User should enable the alarm of cloud storage at first so that the Google drive can receive the recording.

Cloud storage can only be set at motion detection and intelligent analysis interface.

9.3 Alarm

User can set general, motion detection, video loss, intelligent analysis and alarm in on alarm interface.

9.3.1 General

Procedure

Step 1 On the **System Setting** screen, choose **Alarm > General** to access the general interface.

Step 2 Enable alarm to set duration time and buzzer duration time, as shown in Figure 9-16.

Figure 9-16 General interface

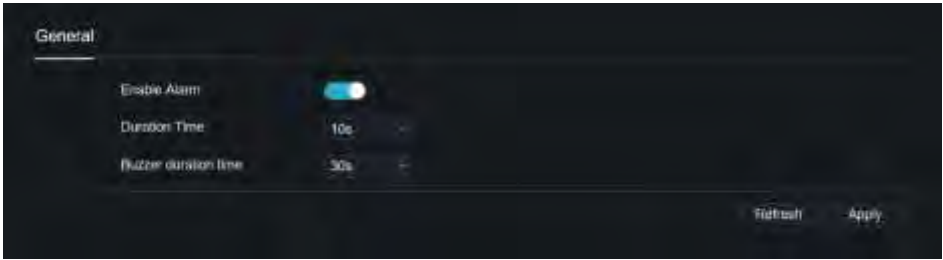

Step 3 Click **Apply** to save settings. Click **Refresh** to return to the previous settings.

----End

9.3.2 Motion Detection

Procedure

Step 1 On the **System Setting** screen, choose **Alarm > Motion Detection** to access the motion detection interface, as shown in Figure 9-17.

Figure 9-17 Motion detection interface



Step 2 Click channel drop-down list to choose channel.

Step 3 Enable motion detection alarm.

Step 4 Set **Event Activity**, includes buzzer, push message to APP, pop-up message to monitor, full screen, Email, cloud storage, alarm out(the back panel), channel alarm out(the port of cameras), and alarm record.

Step 5 Click **Area** to access the motion detection area setting, as shown in Figure 9-18.

Figure 9-18 Motion detection area interface

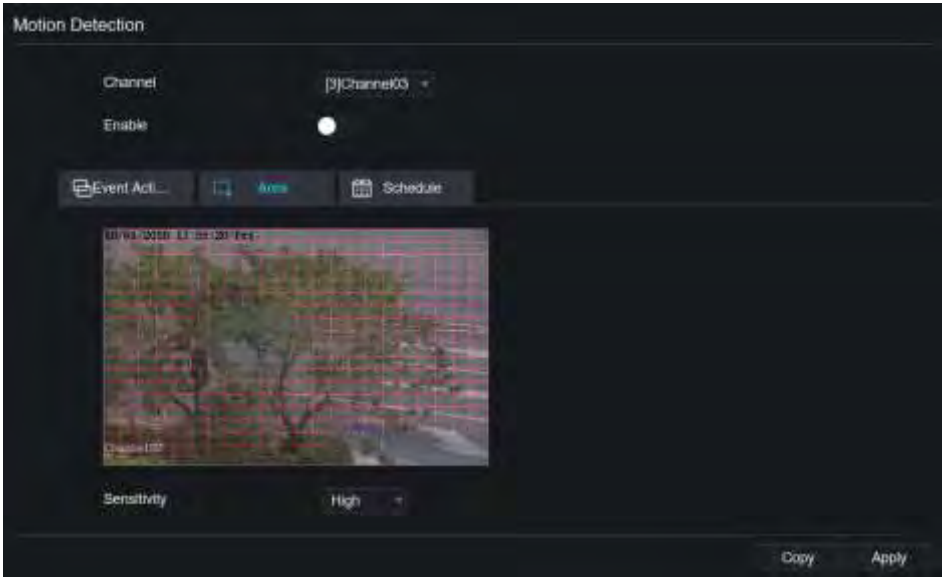

1. Hold down and drag the left mouse button to draw a motion detection area.
2. Select a value from the drop-down list next to **Sensitivity**.
3. Double-click the chosen area to delete.

Step 6 Click **Schedule** to access schedule settings, drag and release mouse to select the alarming time within 00:00-24:00 from Monday to Sunday. Click the chosen area can cancel. The settings of alarm schedule are same as disk schedule.

Step 7 Click **Copy** to choose other camera to copy settings. Click **Apply** to save the settings.

---End

9.3.3 Video Loss

Procedure

Step 1 On the **System Setting** screen, choose **Alarm > Video Loss** to access the video loss interface, as shown in Figure 9-19.

Figure 9-19 Video loss interface



Step 2 Click drop-down list to choose channel.

Step 3 Enable the video loss alarm.

Step 4 Set event activity and schedule please refer to *Figure 5-1 motion detection settings* .

Step 5 Click **Copy** to choose other camera to copy settings. Click **Apply** to save the settings.

----End

9.3.4 Intelligent Analysis

Procedure

Please refer to chapter 7.6.1 *video loss settings*, interface displayed as shown in Figure 9-20.

Figure 9-20 Intelligent analysis interface



9.3.5 Alarm In

Procedure

Step 1 On the **System Setting** screen, choose **Alarm > Alarm In** to access the alarm in interface, as shown in Figure 9-21.

Figure 9-21 Alarm in interface

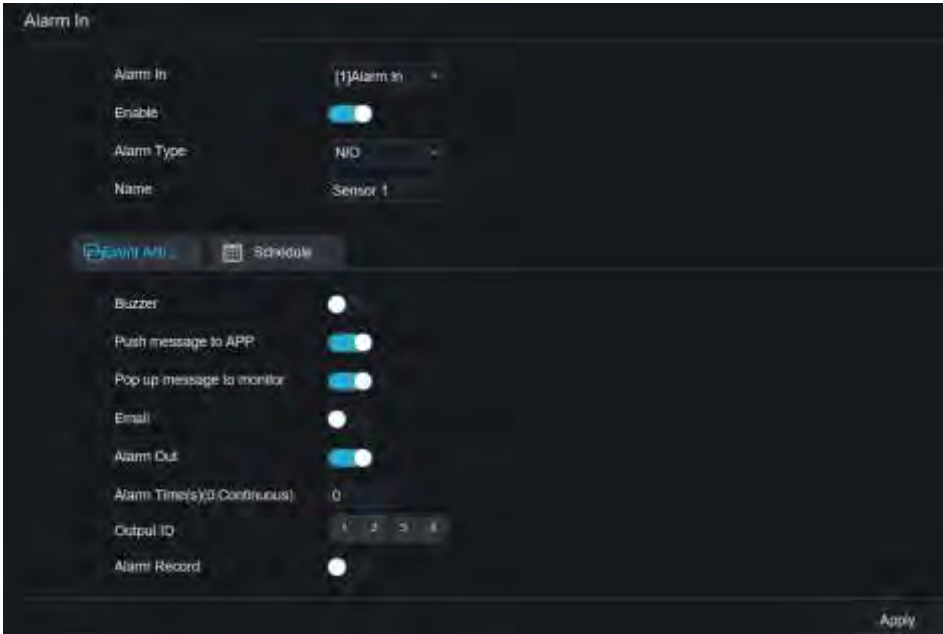

Step 2 Click drop-down list to choose alarm in .

Step 3 Enable the button, choose alarm type.

Step 4 Set name, default is Sensor 1.

Step 5 Set event activity and schedule please refer to *motion detection settings* .

Step 6 Click  to save settings.

----End

9.3.6 Abnormal Alarm

Procedure

Step 1 On the **System Setting** screen, choose **Alarm > Abnormal Alarm** to access the abnormal alarm interface, as shown in Figure 6-11.

Figure 9-22 Abnormal alarm interface



Step 2 Click drop-down list to choose alarm in .

Step 3 Enable the button, tick alarm type.

Step 4 Set name, default is Sensor 1.

Step 5 Set event activity and schedule please refer to *motion detection settings* .

Step 6 Click **Apply** to save settings.

----End

9.4 Network

Users can set Network, DDNS, E-mail, UPnP, P2P, IP Filter, 802.1X, SNMP and Web Mode.

9.4.1 Network

Procedure

Step 1 On the **System Setting** screen, choose **Network > Network** to access the network interface, as shown in Figure 9-23.

Figure 9-23 Network interface



Step 2 Choose network card from the drop-down list. Network card I is LAN1, network card II is LAN2, as shown in Figure 9-24.

Figure 9-24 Network card II



Step 3 Click  next to **IP** to enable or disable the function of automatically getting an IP address. The function is enabled by default.

If the function is disabled, click input boxes next to **IP**, **Subnet mask**, and **Gateway** to set the parameters as required.

Step 4 Click  next to **Obtain DNS Automatically** to enable or disable the function of automatically getting a DNS address. The function is enabled by default.

If the function is disabled, click input boxes next to **DNS1** and **DNS2**, delete original addresses, and enter new addresses.

Step 5 Set **PORT** and **POE** manually, input the information about these.

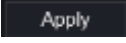
Step 6 Click  to restore previous settings. Click  to save the settings.

----End

9.4.2 DDNS

Procedure

Step 1 Click **DDNS** in the network interface, choose **Network > DDNS** to access the DDNS interface as shown in Figure 9-25.

Figure 9-25 DDNS interface



Step 2 Click the button to enable the DDNS function. It is disabled by default.

Step 3 Select a required value from the **protocol** drop-down list.

Step 4 Set domain name, user, and password.

Step 5 Click **Refresh** to restore previous settings. Click **Apply** to save the settings.

 **NOTE**

An external network can access an address specified in the DDNS settings to access the NVR.

----End

9.4.3 E-mail

Procedure

Step 1 Click **E-mail** in the network interface, choose **Network > E-mail** to access the E-mail interface, as shown in Figure 9-26

Figure 9-26 E-mail interface



Step 2 Set SMTP server and SMTP server port manually.

Step 3 Set sender E-mail, user name and password manually.

Step 4 Set E-mail for receive alarm the message.

Step 5 Set E-mail for retrieve the password the message.

Step 6 Click **SSL Encryption** drop-down list to enable safeguard of email.

Step 7 Click **Refresh** to restore previous settings. Click **Apply** to save the settings.

----End

9.4.4 Port Mapping

Procedure

Step 1 Click **Port Mapping** in the network interface, choose **Network > Port Mapping** to access the UPnP interface as shown in Figure 9-27.

Figure 9-27 Port Mapping interface

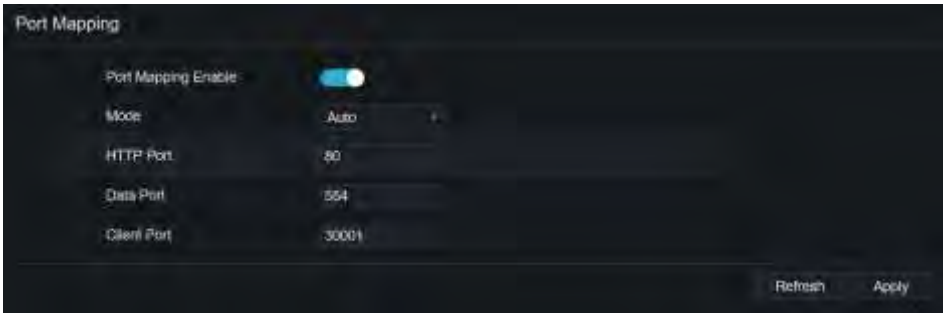

Step 2 Select manner from UPnP enable drop list. The default value is auto.

Step 3 After **UPnP** is manual, set the Web port, data port and client port manually.

Step 4 Click **Refresh** to restore previous settings. Click **Apply** to save the settings.

NOTE

Auto :system perform UPnP automatically.

Manual : the ports distribute by router, you need to refer router then input them.

----End

9.4.5 P2P

Procedure

Step 1 Click **P2P** in the network interface, choose **Network > P2P** to access the P2P interface, as shown in Figure 9-28.

Figure 9-28 P2P interface



Step 2 Click **Enable** to enable the P2P function.

Step 3 Click **Refresh** to restore previous settings. Click **Apply** to save the settings.

Step 4 After the Inview Pro 4 is installed in mobile phone, run the APP and scan the UUID QR code to add then access the NVR when the device is online.

----End

9.4.6 IP Filter

Procedure

Step 1 Click **IP Filter** in the network interface, choose **Network > IP Filter** to access the IP filter interface, as shown in Figure 9-29.

Figure 9-29 IP filter interface

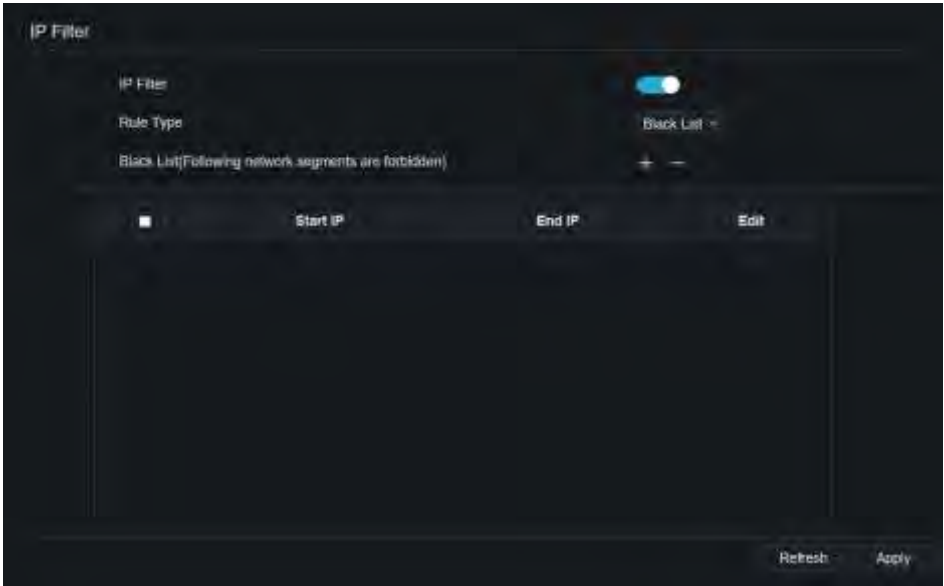

Step 2 Click **Enable** to enable the IP filter function.

Step 3 Click drop-down list of rule type to choose black list or white list.

Step 4 Click , view the pop-up windows to set black list or white list, as shown in 7.7.5.

Click  to delete the list.

Figure 9-30 Black or white list interface

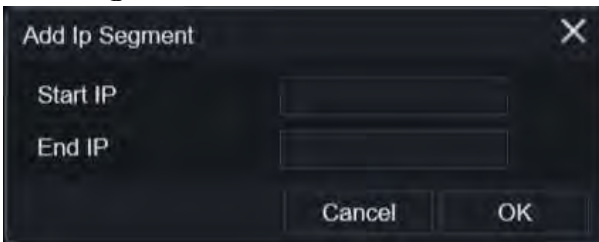

Step 5 Set start IP and end IP.

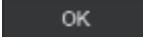
Step 6 Click  to deny settings, click  to save the settings.

Step 7 Click **Refresh** to restore previous settings. Click **Apply** to save the settings.

 **NOTE**

- Black list: IP address in specified network segment to prohibit access.
- White list: IP address in specified network segment to allow access.
- Select a name in the list and click Delete to delete the name from the list.
- Select a name in the list and click Edit to edit the name in the list.
- Only one rule type is available, and the last rule type set is efficient.

----End

9.4.7 802.1X

Procedure

Step 1 Click **802.1X** in the network interface, 802.1X interface is displayed, enable the button, as shown in Figure 9-31.

Figure 9-31 802.1X interface

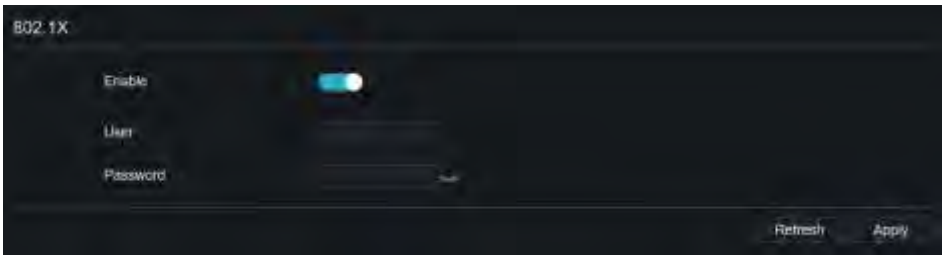

Step 2 Input the user and password of 802.1X authentication.

Step 3 Click **Refresh** to restore previous settings. Click **Apply** to save the settings.

----End

9.4.8 SNMP

Procedure

Step 1 Click **SNMP** in the network interface, SNMP interface is displayed, enable the button aside of SNMPV1, as shown in Figure 9-32.

Figure 9-32 SNMP interface

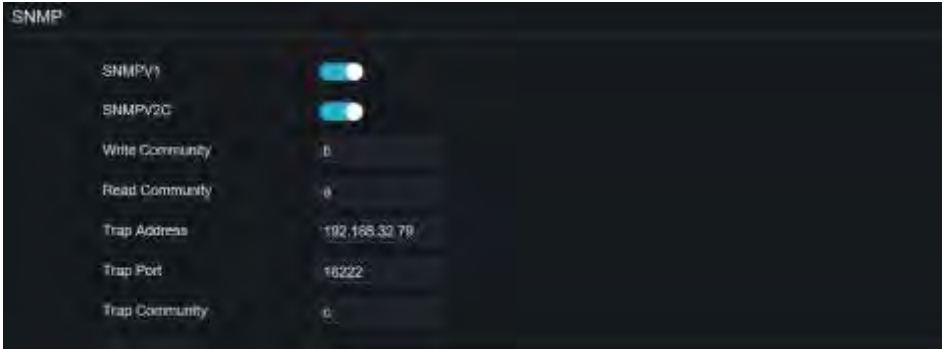

Step 2 Input the information of SNMP (simple network management protocol) . there three types of that function. User can apply that if need.

Table 9-1 SNMP parameters

Parameter	Description	Setting
SMTP Server Address	IP address of the SMTP server.	[Setting method] Enter a value manually.
SMTP Server Port	Port number of the SMTP server.	[Setting method] Enter a value manually. [Default value] 25
User Name	User name of the mailbox for sending emails.	[Setting method] Enter a value manually.
Password	Password of the mailbox for sending emails.	[Setting method] Enter a value manually.
Sender E-mail Address	Mailbox for sending emails.	[Setting method] Enter a value manually.
Recipient_E-mail_Address1	(Mandatory) Email address of recipient 1.	[Setting method] Enter a value manually.
Recipient_E-mail_Address2	(Optional) Email address of recipient 2.	
Recipient_E-mail_Address3	(Optional) Email address of recipient 3.	
Recipient_E-mail_Address4	(Optional) Email address of recipient 4.	
Recipient_E-mail_Address5	(Optional) Email address of recipient 5.	
Attachment Image Quality	A higher-quality image means more storage space. Set this parameter based on the site requirement.	N/A

Parameter	Description	Setting
Transport Mode	Email encryption mode. Set this parameter based on the encryption modes supported by the SMTP server.	[Setting method] Select a value from the drop-down list box. [Default value] No Encrypted

Step 3 Click **Refresh** to restore previous settings. Click **Apply** to save the settings.

----End

9.4.9 Web Mode

Step 1 Click **Web Mode** in the network interface, Web mode interface is displayed, as shown in Figure 5-1.

Figure 9-33 Web mode interface

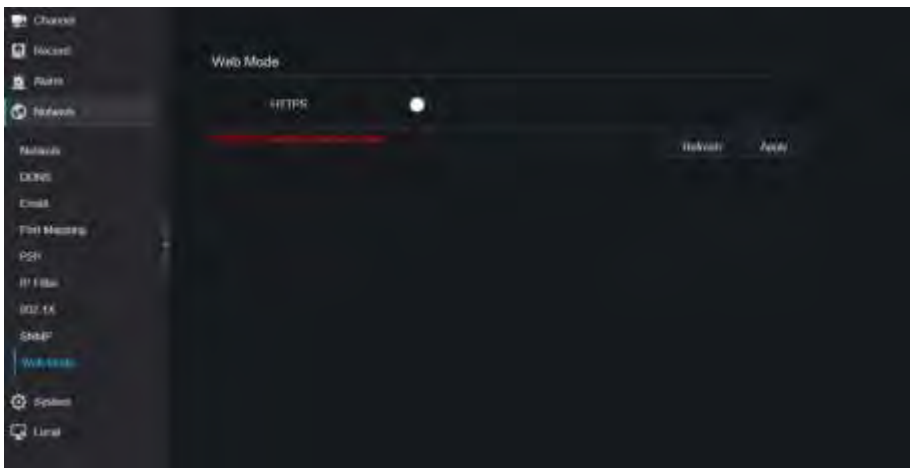

Step 2 Enable the https, the device will restart and start https secure.

Step 3 Click **Refresh** to restore previous settings. Click **Apply** to save the settings.

----End

9.4.10 3G/4G

Figure 9-34 3G/4G

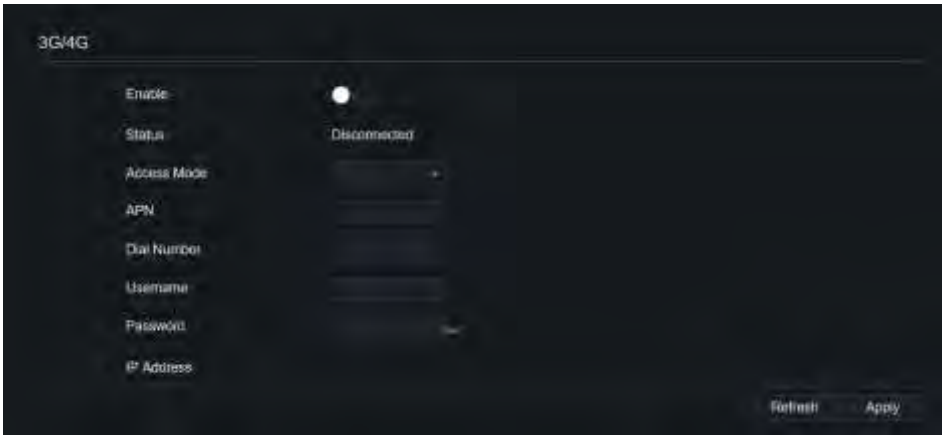

Step 1 The user plug the modem to NVR.

Step 2 Enable the 3G/4G.

Step 3 When the status is connection, user can set the access mode, AUTO is recommended.

Step 4 If choose other access mode, user should input the parameter correctly.

Step 5 Click **Refresh** to restore previous settings. Click **Apply** to save the settings.

9.4.11 PPPOE

User can use PPPOE function to manage the NVR conveniently.

Figure 9-35 PPPOE

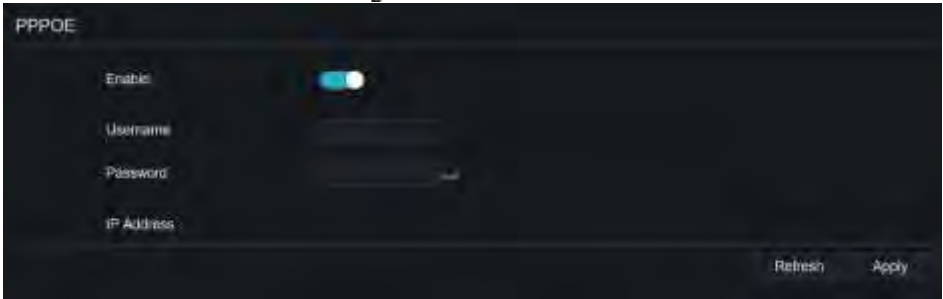

Step 1 Enable the PPPOE.

Step 2 Input the username and password.

Step 3 The IP address is obtained automatically.

Step 4 Click **Refresh** to restore previous settings. Click **Apply** to save the settings.

Step 5 User use the IP address to access NVR immediately.

9.5 System

Users can set parameters about information, general, user, password, logs, maintenance and auto restart.

9.5.1 Device Information

Procedure



Step 1 Click  on the navigation bar, the device information interface is displayed, as shown in Figure 9-36.

Figure 9-36 Device information interface

Information	
Device ID	B011003ACKT78194K
Device Name	Device
Device Type	NVR
Model	NVR3664E0
Firmware Version	M.4.0802.0000.003.0.0.7.0
U-boot Version	130B180E1001
Kernel Version	130C030B1E37
HDD Number	1
Channels Supported	64
Alarm In	16
Alarm Out	1
Audio In	1
Audio Out	1

Step 2 Set the device name according to Table 9-2.

Table 9-2 Device parameters

Parameter	Description	Setting
Device ID	Unique device identifier used by the platform to distinguish the devices.	[Setting method] The parameter cannot be modified.
Device Name	Name of the device.	[Setting method] System Setting > General Modify the device name.
Device Type	N/A	[Setting method]
Model		These parameters cannot be modified.
Firmware version		
HDD volume		
Channel support		

Parameter	Description	Setting
Alarm in		
Alarm out		
Audio in		
Audio out		

----End

9.5.2 General

You can set system, date and time, time zone and DST general interface.

Procedure

Step 1 On the **System Setting** screen, choose **System >General** to access the general interface, as shown in Figure 9-37.

Figure 9-37 Basic setting interface

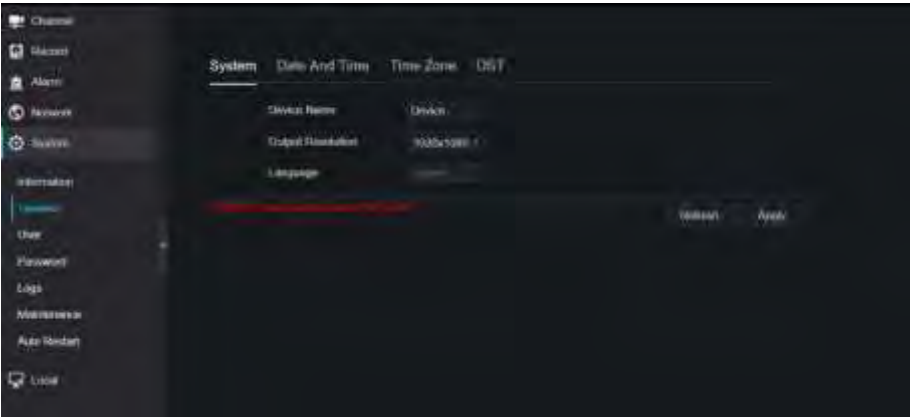

Step 2 Set system.

1. Input the device name.
2. Choose output resolution from drop list.
3. Click **Apply** to save the system setting.

Step 3 Set date and time.

1. Synchronize the time from the NTP server, as shown in Figure 5-8.
2. Click NTP Sync button to enable synchronize time. The default value is enabling.

Figure 9-38 System interface

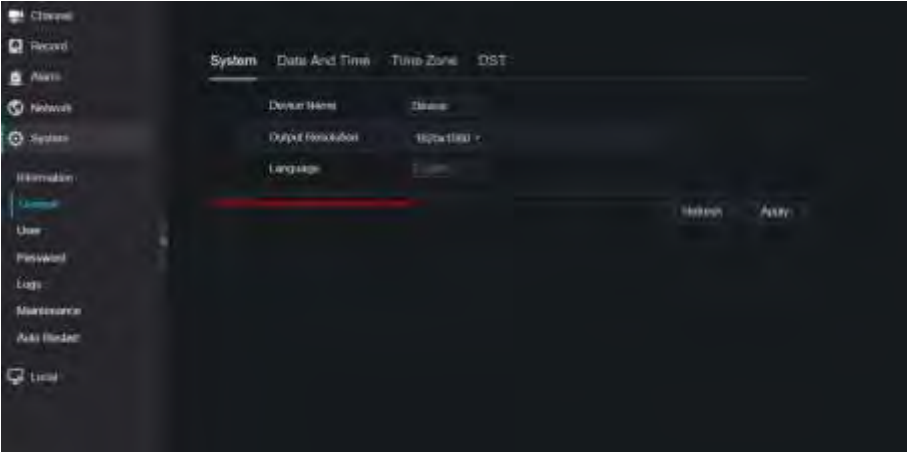

3. Select NTP server, date format and time format from drop list.
4. Click **Apply** to save date and time setting. The device time will synchronize with NTP server time.
5. Set the device time manually, as shown in Figure 9-39.
6. Click NTP Sync button to disable synchronize time.
7. Async date and time interface

Figure 9-39 Date and time



Step 4 Set the time zone.

1. Select date format and time format from the drop-down list.
2. Click **Apply** to save the device time setting. Click **Refresh** to return to previous setting.

Step 5 Set time zone.

Click **Time Zone** to enter the time zone setting interface, as shown in Figure 9-40.

Time zone setting interface

Figure 9-40 Time zone

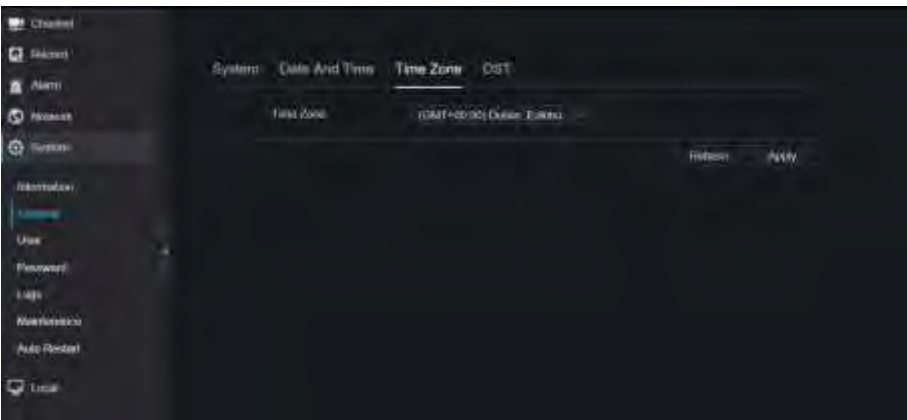

Select a time zone from the drop-down list.

Click **Apply** to save the time zone setting. Click **Refresh** to return to previous setting.

Step 6 Set DST.

1. Click DST to enter the DST setting interface, click DST button to enable, as shown in Figure 9-41. The button is disable by default.

Figure 9-41 DST setting interface

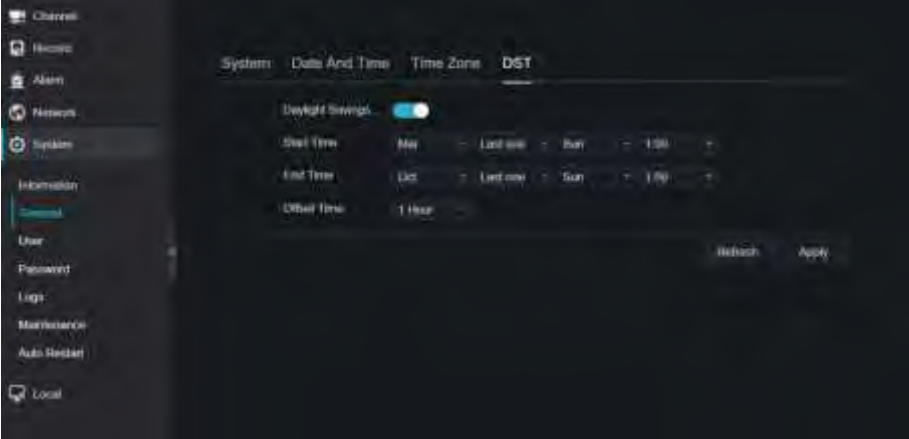

- Select a start time from the drop-down list.
- Select an end time from the drop-down list.
- Select an offset time from the drop-down list.

Click **Apply** to save the DST setting. Click **Refresh** to return to previous setting.

9.5.3 User

You can create new user accounts to manage the device.

9.5.3.1 Add User

Procedure

- Step 1 On the **System Setting** screen, choose **System >User** to access the **User** interface, as shown in Figure 9-42.

Figure 9-42 User interface

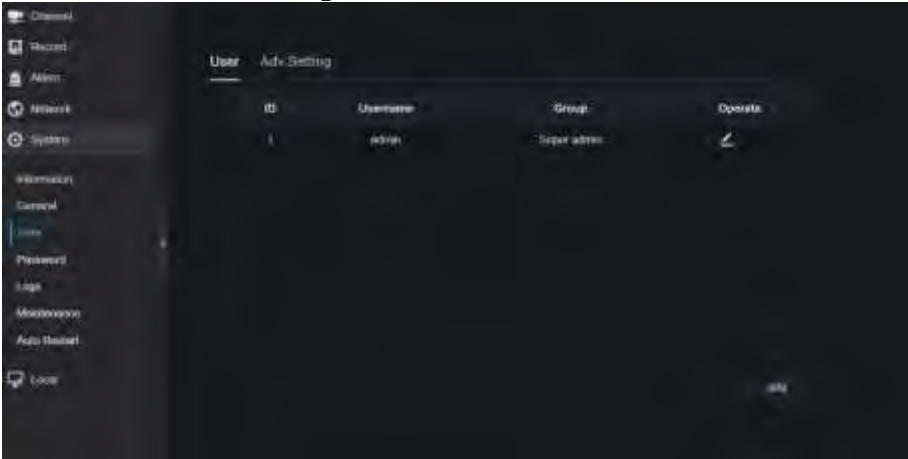

Step 2 Click **Add** to add a new user, as shown in Figure 9-43.

Figure 9-43 Add user

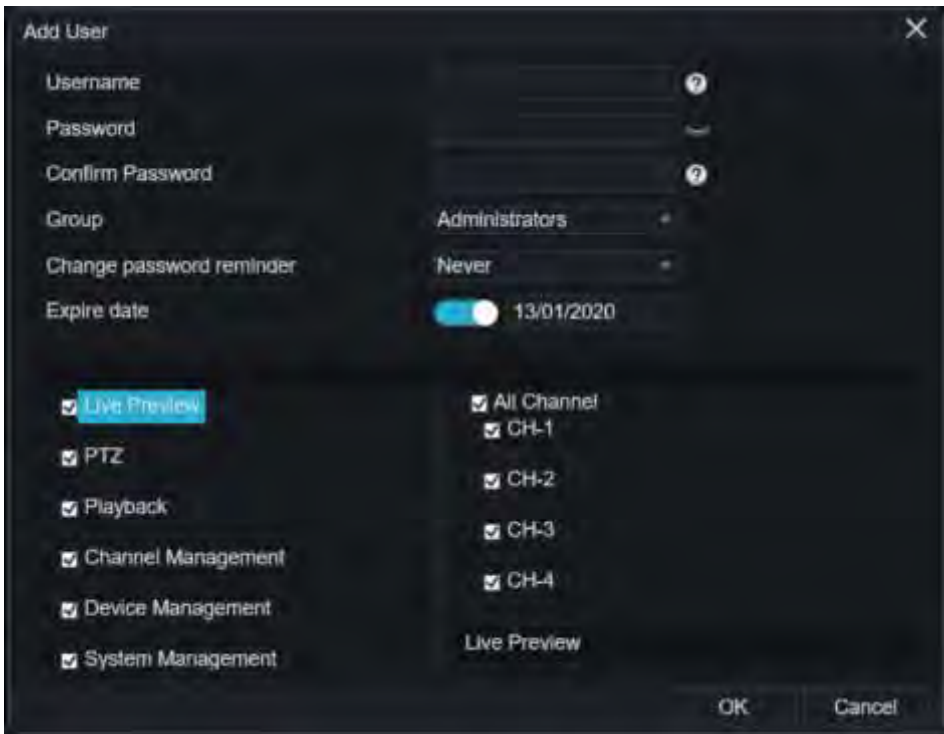

Step 3 Input username, password and confirm password.

Step 4 Select group and change password reminder from drop-down list.

Step 5 Assign the privilege to user.

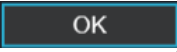

Step 6 Enable the expire date to set the new user's authority time.

Step 7 Select channels to manage.

Step 8 Click , the message "Add success" is showed. If the password is not

meet the rule, it would show .

Step 9 Click  to edit user's information.

Step 10 Click  to delete the account, it would show .

click  to delete.

----End

9.5.3.2 Adv.Setting

Procedure

Step 1 On the **System Setting** screen, choose **System >User > Adv. Setting** to access interface, as shown in Figure 9-44.

Figure 9-44 Adv. Setting interface

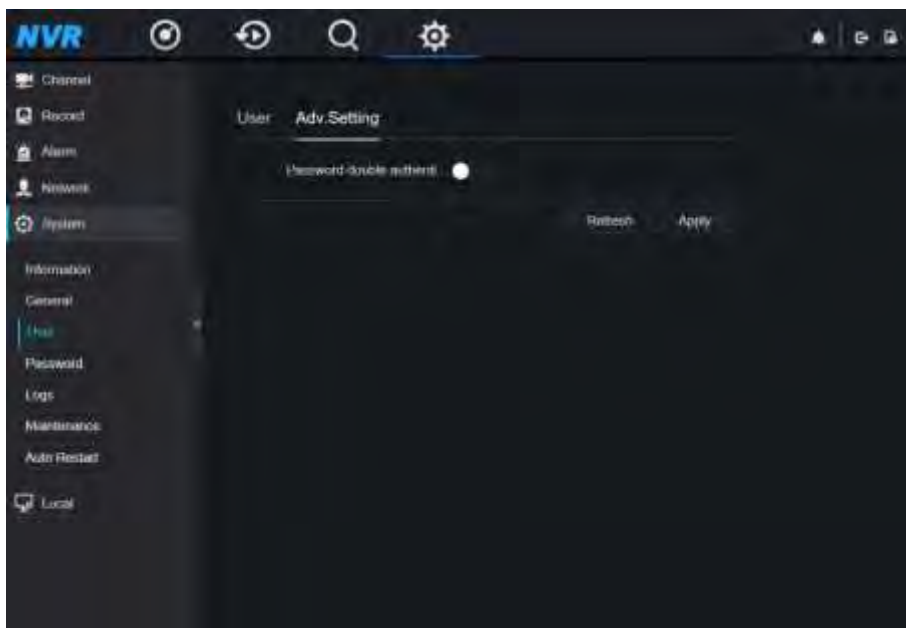

Step 2 Enable the **Password double authentication**. If the user want to playback video , he need input another username and password to authenticate.

Step 3 Click **Apply** to save the device time setting. Click **Refresh** to return to previous setting.

9.5.4 Security Center

9.5.4.1 Password

Procedure

Step 1 On the **System Setting** screen, choose **System >Security Center** to access password interface, as shown in Figure 9-45.

Figure 9-45 Password interface

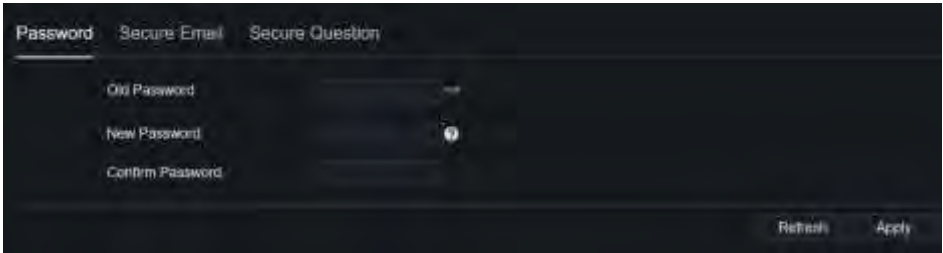

Step 2 Input old password, new password and confirm password.

Step 3 Click **Apply** to save settings. Click **Refresh** to return to previous setting.

NOTE

Valid password range [6-32] characters.

At least 2 kinds of numbers, lowercase, uppercase or special character contained.

Only special characters are support !@#*\$%+=-.

9.5.4.2 Secure Email

The secure email can receive the verification code of NVR, if user forgot the password accidentally.

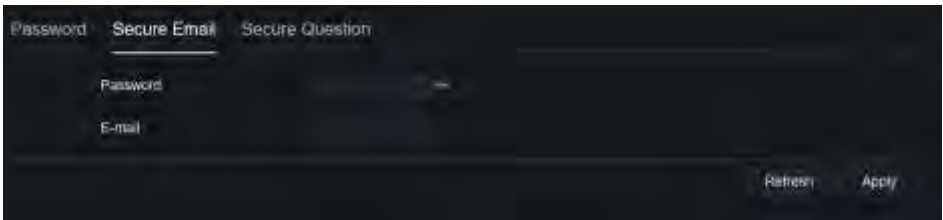

9.5.4.3 Secure Question

User can modify the password to login the NVR if user forgot the password and answer correctly the secure questions.

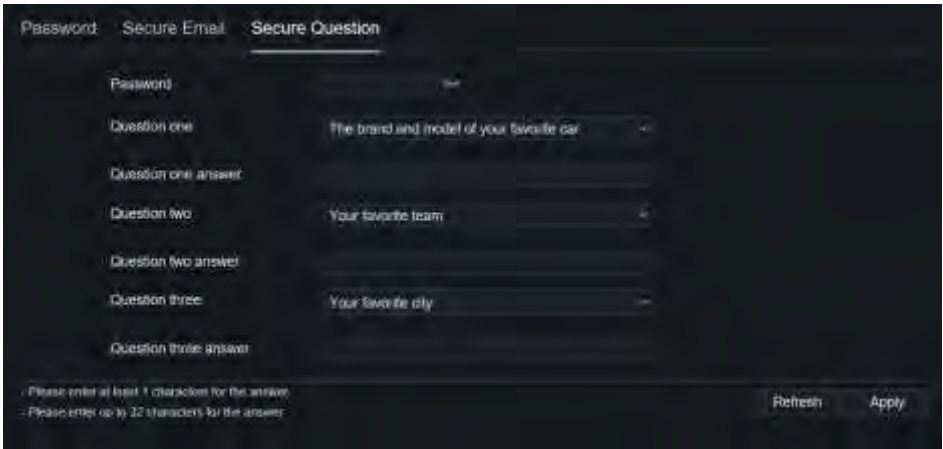

----End

9.5.5 Logs

Procedure

Step 1 On the **System Setting** screen, choose **System >Logs** to access logs interface, as shown in Figure 9-46.

Figure 9-46 Logs interface

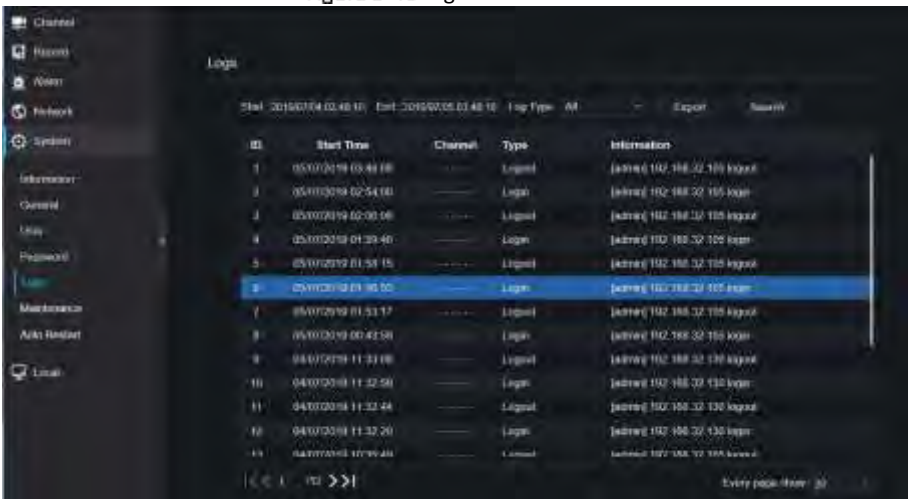

Step 2 Set start and end time from calendar.

Step 3 Select log type from drop-down list.

Step 4 Click **Search** to acquire log information.

Step 5 Click **Export** to export the logs.

----End

9.5.6 Maintenance

Procedure

Step 1 On the **System Setting** screen, choose **System >Maintenance** to access maintenance interface, as shown in Figure 9-47.

Figure 9-47 Maintenance interface

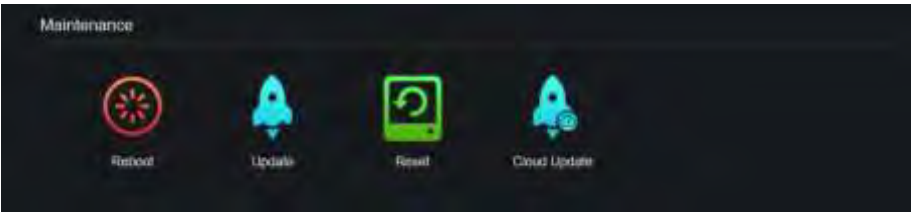

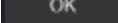
Step 2 Click **Reboot**, the pop-up message would show you, click  to reboot.

Step 3 Click **Update**, the message shows , choose software from specific location to update.

Step 4 Click **Reset**, the pop-up message  shows to you, click

 to reset.

Step 5 If the device is online, and the cloud server has the software, click the **Cloud Update**, it shows 'make sure to update', click **OK** to update.

----End

9.5.7 Auto Restart

Procedure

Step 1 On the **System Setting** screen, choose **System > Auto Restart** to access auto restart enable the auto restart, the screen as shown in Figure 9-48.

Figure 9-48 Auto restart



Step 2 Select one type of restart time from drop-down list.

Step 3 Click **Apply** to save settings. Click **Refresh** to return to previous setting.

9.6 Local

Set the image download path for snapshot and the record download path for record files in the download configuration interface.

Procedure

Step 1 Click **Local Download Config** in local interface, as shown in Figure 9-49.

Figure 9-49 Local interface

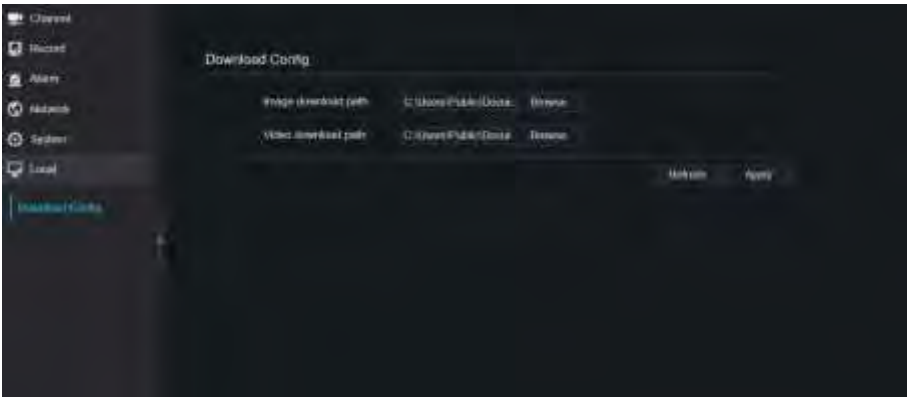

Step 2 Enter the image download path.

Step 3 Enter the record download path.

Step 4 Click **Refresh** to return the previous settings. Click **Apply** to save the settings.

----End

10 Disk Compatibility

The hard disks in the following list are tested and certified by our company, if you want to use other hard disks, please consult to our technical staff.

Table 10-1 Disk specification

Disk Brand	Type	Capacity	Model	Parameter	Verification of Platform
WD(Western Digital)	Monitoring level	3T	WD30EJRX-89G3VY0	3000G/ 5400RPM/64MB /SATA	NVR25 Series /NVR 26 Series /ADR33 Series /ADR36 Series
		1T	WD10EJRX-89N74Y0	1000G/5400RPM /64MB/SATA	NVR25 Series /NVR 26 Series /ADR33 Series /ADR36 Series
		4T	WD40PURX-64GVNY0	4000G/5400RPM /64MB/SATA	NVR25 Series /NVR 26 Series /ADR33 Series /ADR36 Series
		2T	WD20EURS-63S48Y0		NVR25 Series /NVR 26 Series /ADR33 Series /ADR36 Series
		3T	WD30EURS-63SPKY0		NVR25 Series /NVR 26 Series /ADR33 Series /ADR36 Series
		0.5T	WD5000AA KK-001CA0		NVR25 Series /NVR 26 Series /ADR33 Series /ADR36 Series
		1T	WD10EZEX-00BN5A0	1000G/7200RPM /64MB/SATA	NVR25 Series /NVR 26 Series /ADR33 Series /ADR36 Series
		4T	WD40EJRX-89T1XY0	4000G/5400RPM /64MB/SATA	NVR25 Series /NVR 26 Series /ADR33 Series /ADR36 Series

		3T	WD30PURX-64P6ZY0	3000G/5400RPM /64MB/SATA	NVR25 Series /NVR 26 Series /ADR33 Series /ADR36 Series
		6T	WD60PURX-64WYOY1	6000G/5400RPM /64MB/SATA	NVR25 Series /NVR 26 Series /ADR33 Series /ADR36 Series
		8T	WD82EJRX-89AD9Y0		NVR25 Series /NVR 26 Series /ADR33 Series /ADR36 Series
	Desktop	12T	WD121EJRX-89S5UY0	7200RPM/256MB/SATA	NVR25 Series /NVR 26 Series /ADR33 Series /ADR36 Series
Seagate	Monitoring level	2T	ST2000VX000	2000G/5900RPM /64MB/SATA	NVR25 Series /NVR 26 Series /ADR33 Series /ADR36 Series
		2T	ST2000VX008	2000G/5900RPM /64MB/SATA	NVR25 Series /NVR 26 Series /ADR33 Series /ADR36 Series
		4T	ST4000VX000	4000G/5900RPM /64MB/SATA	NVR25 Series /NVR 26 Series /ADR33 Series /ADR36 Series
		3T	ST3000VX000	3000G/5900RPM /64MB/SATA	NVR25 Series /NVR 26 Series /ADR33 Series /ADR36 Series
		4T	ST3000VX010		NVR25 Series /NVR 26 Series /ADR33 Series /ADR36 Series
		1T	ST31000528AS		NVR25 Series /NVR 26 Series /ADR33 Series /ADR36 Series
		6T	ST6000VX0001		NVR25 Series /NVR 26 Series /ADR33 Series

					/ADR36 Series
		3T	ST3000VX01 0	3000G/5900RPM /64MB/SATA	NVR25 Series /NVR 26 Series /ADR33 Series /ADR36 Series
		8T	ST8000VX00 02		NVR25 Series /NVR 26 Series /ADR33 Series /ADR36 Series
	Enterprise level	6T	ST6000VNO 011	6000G/7200RPM /128MB/SATA	NVR25 Series /NVR 26 Series /ADR33 Series /ADR36 Series
Toshiba	Monitoring level	1T	DT01ABA10 0V	1000G/5400 RPM /32MB/SATA	NVR25 Series /NVR 26 Series /ADR33 Series /ADR36 Series

Video recording size per channel per hour =bitrate (kbps)*3600/1200/8 (M)

Recording duration =Total hard disk capacity (M) / Video recording size per channel per hour /
number channels (H)